

Area Safe Products Industrial Safety CATALOGUE

40



→ Customer Focused

→ Speedy Service

→ Innovative products



2025
Edition

phone 1300 613 880

Web www.areasafe.com.au
Email sales@areasafe.com.au



Why Choose Area Safe Products?

Customer Focused



Speedy Service



Innovative Products



Create an Area Safe Products login to:

- View trade prices
- Download spec sheets, assembly guides, installation procedures and maintenance recommendations.

Contact us

Email: sales@areasafe.com.au
Web: www.areasafe.com.au
Mail: PO Box 82, Plumpton NSW 2761

Address: Sydney: 17 Sterling Road, Minchinbury, NSW 2770 (Head Office, Warehouse & Production)

Melbourne: Suite 208/15 Cochranes Road, Moorabbin VIC 3189 (Office only)

Brisbane: Level 11, Suite 5, 88 Tribune Street, South Brisbane QLD 4101 (Office only)

Open: 7:00am - 5:00pm, Monday-Friday

ABN: 74 114 414 185

Phone: 1300 613 880

All prices advertised through this catalogue exclude 10% GST. Design & prices subject to change without notice. E&OE © 2024 Area Safe Products Pty Ltd.



Contents

Industrial products

AREA SAFE
PRODUCTS

OCTOBER
2025

SPECIALITY
CATALOGUE #40

Surex Pedestrian Rail Kits	4	Machine Guarding	41
Modular Fencing	7	Downpipe Guards	46
Surex Gates and Barriers	15	Surex Low Recessed Rails	49
W-Beam Guard Rails	22	Steel Truck Loading Dock Reversing Guides	50
Driver Safe Zone Kits	29	Corner Guards	51
U-Bollards	30	Rubber Guards	53
Swing and Boom Gates	32	Rubber Protectors	54
Loading Dock Stairs	39	Document Holder	55

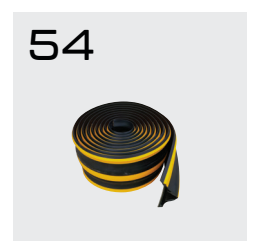
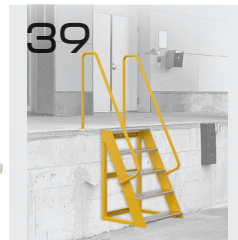
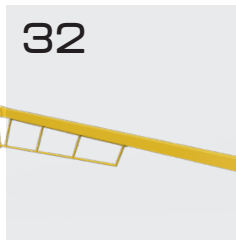
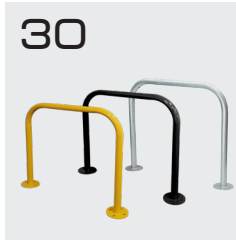

Pedestrian Rail Features

1. High quality gloss safety yellow powder coat
2. Easily customisable
3. Heavy duty customisable cast fittings
4. Modular construction - easy install & repair
5. Heavy duty 48mm gal pipe



✓ We can powder coat the colour to your specific colour requirements

Modular Pedestrian Rail - Yellow



Modular Pedestrian Rail - Yellow



Modular Pedestrian Rail and Pedestrian Gate - Yellow



Modular Pedestrian Rail - Yellow



Surex Pedestrian Rail Kits Rail Kits - Safety Yellow

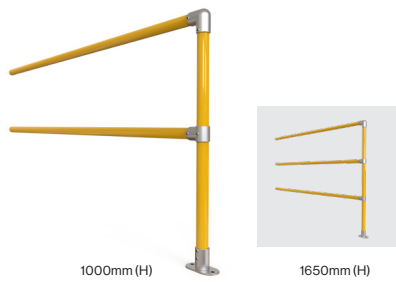

End Section Kit

- Includes: 1 x End Post, 2 x Rails (3x Rails for 1650mm)
- Post: Ø48 x 950mm (overall height 1000mm) / Ø48 x 1600 (Overall Height 1650mm)



code	overall size	1+
11-MHRE	1000(H)mm x 2200(L)mm - 2 rails	\$319.00 / set
11-MHRE-165	1650(H)mm x 2200(L)mm - 3 rails	\$499.00 / set

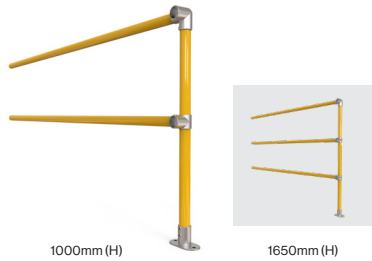

Corner Section Kit

- Includes: 1 x Corner Post, 2 x Rails (3x Rails for 1650mm)
- Rails: Ø48 x 2160(L)mm
- Post: Ø48 x 950mm (overall height 1000mm) / Ø48 x 1600 (Overall Height 1650mm)



code	overall size	1+
11-MHRC	1000(H)mm x 2200(L)mm - 2 rails	\$319.00 / set
11-MHRC-165	1650(H)mm x 2200(L)mm - 3 rails	\$499.00 / set

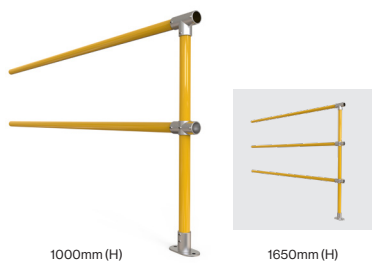

Mid Section Kit

- Includes: 1 x Intermediate Post, 2 x Rails (3x Rails for 1650mm)
- Rails: Ø48 x 2160(L)mm
- Post: Ø48 x 950mm (overall height 1000mm) / Ø48 x 1600 (Overall Height 1650mm)



code	overall size	1+
11-MHRM	1000(H)mm x 2200(L)mm - 2 rails	\$319.00 / set
11-MHRM-165	1650(H)mm x 2200(L)mm - 3 rails	\$499.00 / set

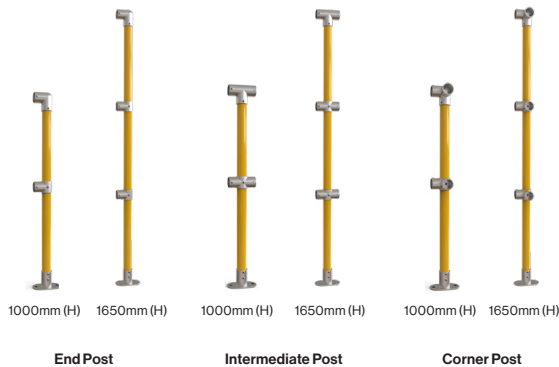

Post, Rail and Fastener Kits

- Includes post and fittings
- Post: Ø48 x 950mm (overall height 1000mm) / Ø48 x 1600 (Overall Height 1650mm)



code	description	overall height	1+
11-MHR-PE	End Post with fittings	1000mm	\$165.00 / set
11-MHR-PE-165	End Post with fittings	1650mm	\$245.00 / set
11-MHR-PM	Intermediate Post with fittings	1000mm	\$165.00 / set
11-MHR-PM-165	Intermediate Post with fittings	1650mm	\$245.00 / set
11-MHR-PC	Corner Post with fittings	1000mm	\$165.00 / set
11-MHR-PC-165	Corner Post with fittings	1650mm	\$245.00 / set
11-MH-PCRAIL	Horizontal Rail (ø48mm x 2160mm Yellow)		\$115.00 / ea
08-GSB1275X2	M12 x 75mm Galvanised Screw Bolt - Set of 2 (Requires 1 Set of Fasteners Per Base Plate)		\$4.95 / set

Self Closing Gate Kits - Safety Yellow

See Page 91



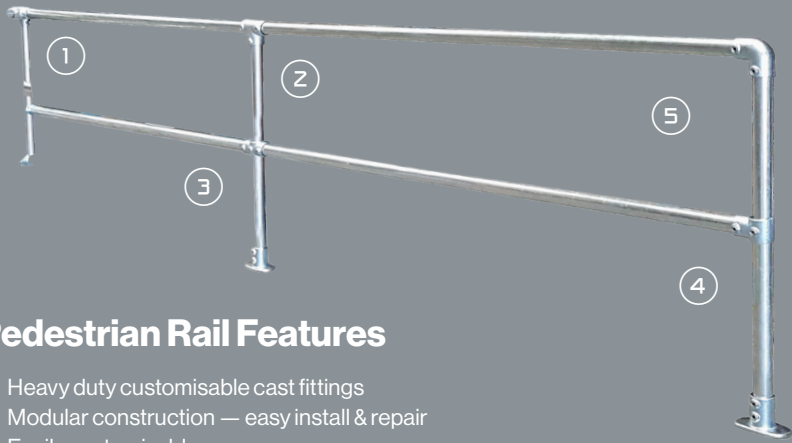

Pedestrian Rail Features

1. Heavy duty customisable cast fittings
2. Modular construction — easy install & repair
3. Easily customisable
4. Heavy duty 48mm gal pipe
5. High quality galvanised finish

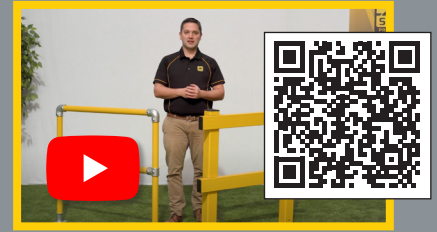

“Recessed Rail vs Modular Pedestrian Rail Which suits my needs?”



Modular Pedestrian Rail - Galvanised



Modular Pedestrian Rail - Galvanised

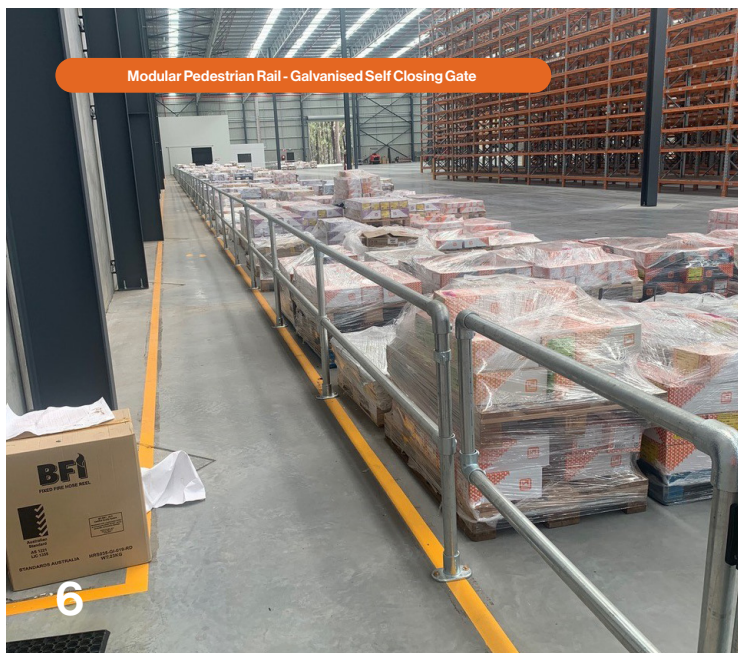

Modular Pedestrian Rail - Galvanised Self Closing Gate

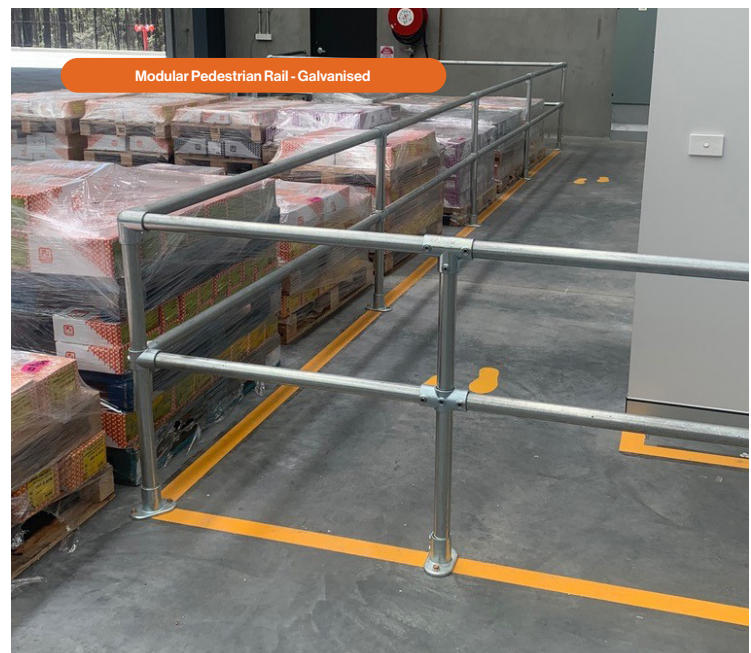

Modular Pedestrian Rail - Galvanised

Surex Pedestrian Rail Kits Galvanised



End Section Kit

- Includes: 1 x End Post, 2 x Rails (3x Rails for 1650mm)
- Rails: Ø48 x 2160(L)mm
- Post: Ø48 x 950mm (overall height 1000mm) / Ø48 x 1600 (Overall Height 1650mm)



code	overall size	1+
11-MHRE-G	1000(H)mm x 2200(L)mm - 2 Rails	\$229.00 / set
11-MHRE-G-165	1650mm x 2200(L)mm - 3 rails	\$369.00 / set

Corner Section Kit

- Includes: 1x Corner post, 2 Rails (3x Rails for 1650mm)
- Rails: Ø48 x 2160(L)mm
- Post: Ø48 x 950mm (overall height 1000mm) / Ø48 x 1600 (Overall Height 1650mm)



code	overall size	1+
11-MHRC-G	1000(H)mm x 2200(L)mm - 2 rails	\$229.00 / set
11-MHRC-G-165	1650mm x 2200(L)mm - 3 rails	\$339.00 / set

Mid Section Kit

- Includes: 1 x Intermediate Post, 2 x Rails (3x Rails for 1650mm)
- Rails: Ø48 x 2160(L)mm
- Post: Ø48 x 950mm (overall height 1000mm) / Ø48 x 1600 (Overall Height 1650mm)



code	overall size	1+
11-MHRM-G	1000(H)mm x 2200(L)mm	\$229.00 / set
11-MHRM-G-165	1650mm x 2200(L)mm - 3 rails	\$369.00 / set

Post, Rail and Fastener Kits

- Includes post and fittings
- Size: Ø48 x 1000mm (overall) / Ø48 x 1600 (Overall 1650mm)



code	description	overall height	1+
11-MHR-PE-G	End Post with fittings	1000mm	\$139.00 / set
11-MHR-PE-G-165	End Post with fittings	1650mm	\$215.00 / set
11-MHR-PM-G	Intermediate Post with fittings	1000mm	\$139.00 / set
11-MHR-PM-G-165	Intermediate Post with fittings	1650mm	\$215.00 / set
11-MHR-PC-G	Corner Post with fittings	1000mm	\$139.00 / set
11-MHR-PC-G-165	Corner Post with fittings	1650mm	\$215.00 / set
STEEL40NBx2160	Horizontal Rail (ø48mm x 2160mm Galvanised)		\$79.90 / ea
08-GSB1275X2	M12 x 75mm Galvanised Screw Bolt - Set of 2 (Requires 1 Set of Fasteners Per Base Plate)		\$4.95 / set

Self Closing Gate Kits - Galvanised

See Page 91



Surex Pedestrian Rail Kits Black

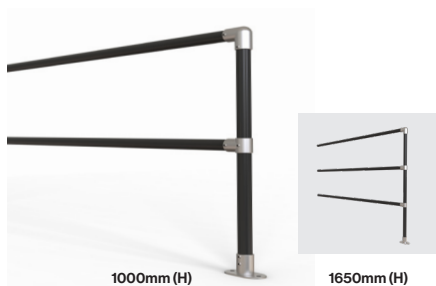

End Section Kit

- Includes: 1 x End Post, 2 x Rails (3x Rails for 1650mm)
- Rails: Ø48 x 2160(L)mm
- Post: Ø48 x 950mm (overall height 1000mm) / Ø48 x 1600 (Overall 1650mm)



code	overall size	1+
11-MHRE-B	1000(H) x 2200(L)mm - 2 rails	\$359.00 / ea
11-MHRE-B-165	1650(H) x 2200(L)mm - 3 rails	\$569.00 / ea

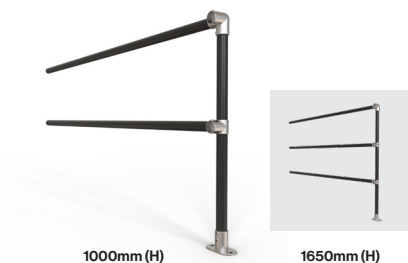

Corner Section Kit

- Includes: 1x Corner post, 2 x Rails (3x Rails for 1650mm)
- Rails: Ø48 x 2160(L)mm
- Post: Ø48 x 950mm (overall height 1000mm) / Ø48 x 1600 (Overall 1650mm)



code	overall size	1+
11-MHRC-B	1000(H) x 2200(L)mm - 2 rails	\$359.00 / ea
11-MHRC-B-165	1650(H) x 2200(L)mm - 3 rails	\$569.00 / ea



Mid Section Kit

- Includes: 1x Intermediate Post, 2 x Rails (3x Rails for 1650mm)
- Rails: Ø48 x 2160(L)mm
- Post: Ø48 x 950mm (overall height 1000mm) / Ø48 x 1600 (Overall 1650mm)



code	overall size	1+
11-MHRM-B	1000(H) x 2200(L)mm - 2 rails	\$359.00 / ea
11-MHRM-B-165	1650(H) x 2200(L)mm - 3 rails	\$569.00 / ea

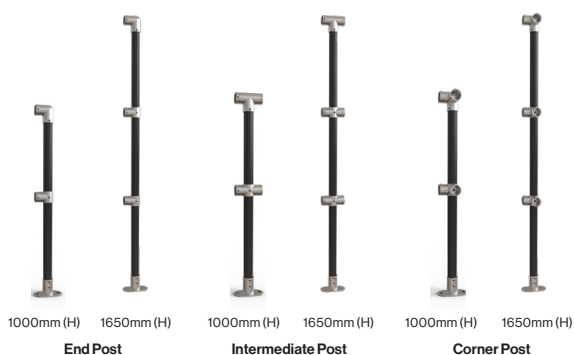

Post, Rail and Fastener Kits

- Includes post and fittings
- Size: Ø48 x 1000mm (overall) / Ø48 x 1600 (Overall 1650mm)



code	description	height	1+
11-MHR-PE-B	End Post with fittings	1000mm	\$175.00 / ea
11-MHR-PE-B-165	End Post with fittings	1650mm	\$259.00 / ea
11-MHR-PM-B	Intermediate Post with fittings	1000mm	\$175.00 / ea
11-MHR-PM-B-165	Intermediate Post with fittings	1650mm	\$259.00 / ea
11-MHR-PC-B	Corner Post with fittings	1000mm	\$175.00 / ea
MHR-PC-B-165	Corner Post with fittings	1650mm	\$259.00 / ea
-11-MH-PCRAIL-B	Horizontal Rail - (ø48mm x 2160mm Black)		\$119.00 / ea
08-GSB1275X2	M12 x 75mm Galvanised Screw Bolt - Set of 2 (Requires 1 Set of Fasteners Per Base Plate)		\$4.95 / set

Self Closing Gate Kits - Black

See Page 91



Surex DDA Pedestrian Rail Kits



End Section Kit DDA

- Includes: 1x Post, 1x 180° Rail End
- Size: 1065(H) x 350(W)mm



code	colour	1+
11-MHRDDA-PE	Yellow	\$295.00 / set
11-MHRDDA-PE-G	Gal	\$295.00 / set



Mid Section Kit DDA

- Includes: 1x Intermediate Mid Post and 2 Rails
- Rails: Ø48 x 2160(L)mm (overall length 2200mm)
- Post: Ø48 x 950(H) (overall height 1065mm)



code	colour	size	1+
11-MHRDDAM	Yellow	1065(H)x2200(L)mm	\$359.00 / set
11-MHRDDAM-G	Gal	1065(H)x2200(L)mm	\$359.00 / set



Corner Section Kit DDA

- Includes: 2x Posts and 2x 90°
- Corner Bends - Size: 1065(H) x 300(W)



code	colour	1+
11-MHRDDA-PC	Yellow	\$535.00 / set
11-MHRDDA-PC-G	Gal	\$535.00 / set



Intermediate Mid Post DDA

- Includes: Post & fittings
- Size: Ø48 x 1065(H)mm (Overall)



code	colour	1+
11-MHRDDA-PM	Yellow	\$185.00 / set
11-MHRDDA-PM-G	Gal	\$185.00 / set

Surex DDA Pedestrian Rail Components



code	description	1+
-11-MH-PCRAIL	Horizontal Rail (ø48 x 2160mm Yellow)	\$115.00 / ea
-STEEL40NBX2160	Horizontal Rail (48 x 2160mm Gal)	\$79.90 / ea
-11-MH-PCUPRIGHT	Vertical Post (ø48 x 940mm Yellow)	\$58.90 / ea
-STEEL40NBX950	Vertical Post (ø48 x 940 Gal)	\$44.90 / ea
-721D48Y	DDA Assist 180° Hand Rail End Return (300 x 457mm Yellow)	\$169.00 / ea
-721D48G	DDA Assist 180° Hand Rail End Return (300 x 457mm Gal)	\$139.00 / ea
-720D48Y	DDA Assist Hand Rail - 90° Corner Bend (300 x 300mm Yellow)	\$129.00 / ea
-720D48G	DDA Assist Hand Rail - 90° Corner Bend (300 x 300mm Gal)	\$109.00 / ea
-133D48	Black Plastic Stop End	\$6.90 / ea
-724C42	DDA J-End Rail (Ø42 x 1600mm Gal)	\$335.00 / ea
08-GSB1275X2	M12 x 75mm Galvanised Screw Bolt - Set of 2 (Requires 1 Set of Fasteners Per Base Plate)	\$4.95 / set

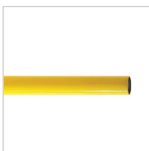

11-MH-PCRAIL



STEEL40NBx2160



11-MH-PCUPRIGHT



STEEL40NBx950

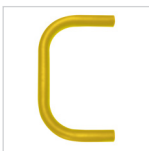

721D48Y



721D48G



720D48Y



720D48G



133D48

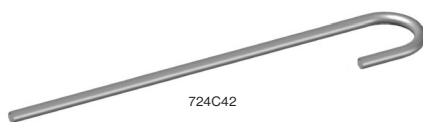

724C42

Surex Pedestrian 'Tall-Rail' Kits Safety Yellow

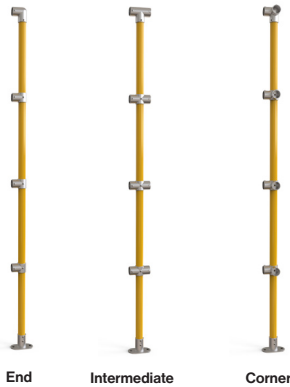

End Section Kit 'Tall-Rail'



- Includes: 1x End Post, 4 x Rails
- Rails: Ø48 x 2160(L)mm (overall length 2200mm)
- Post: Ø48 x 2160mm (overall height 2200mm)

code	overall size	1+
11-MTRE	2200(H)x2200(L)mm - 4 Rails	\$649.00 / set

Corner Section Kit 'Tall-Rail'



- Includes: 1x Corner post, 4 x Rails
- Rails: Ø48 x 2160(L)mm (overall length 2200mm)
- Post: Ø48 x 2160mm (overall height 2200mm)

code	overall size	1+
11-MTRC	2200(H)x2200(L)mm - 4 Rails	\$649.00 / set

Mid Section Kit 'Tall-Rail'



- Includes: 1x Intermediate post, 4 x Rails
- Rails: Ø48 x 2160(L)mm (overall length 2200mm)
- Post: Ø48 x 2160mm (overall height 2200mm)

code	overall size	1+
11-MTRM	2200(H)x2200(L)mm - 4 Rails	\$649.00 / set

Post, Rail, Brace & Fastener Kits 'Tall Rail'



- Includes post and fittings
- Size: Ø48 x 2200mm (overall)

code	description	1+
11-MTR-PE	Yellow End Post with fittings	\$285.00 / set
11-MTR-PM	Yellow Intermediate Post with fittings	\$285.00 / set
11-MTR-PC	Yellow Corner Post with fittings	\$285.00 / set
11-MH-PCRAIL	Yellow Horizontal Rail - (ø48mm x 2160mm)	\$115.00 / ea
11-MTR-R2R-Y	Rail To Rail Brace Yellow - 1000mm	\$165.00 / set
11-MTR-W2R-Y	Wall To Rail Brace Yellow - 1000mm	\$165.00 / set
08-GSB1275X2	M12 x 75mm Galvanised Screw Bolt - Set of 2 (Requires 1 Set of Fasteners Per Base Plate)	\$4.95 / set

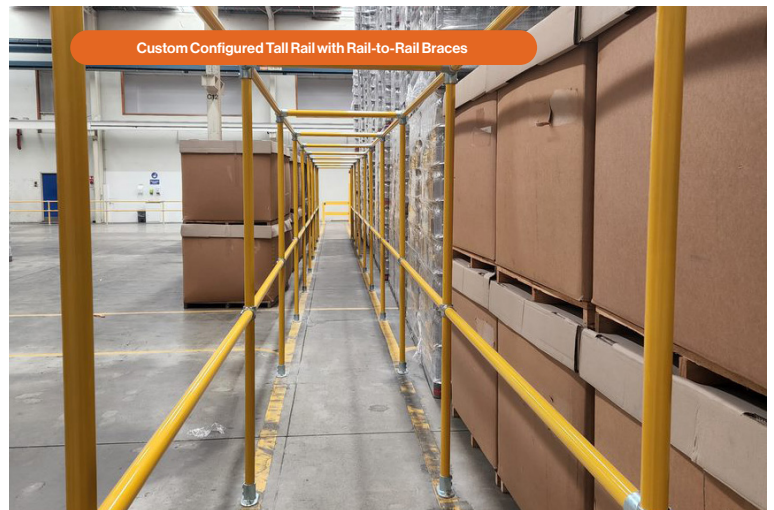
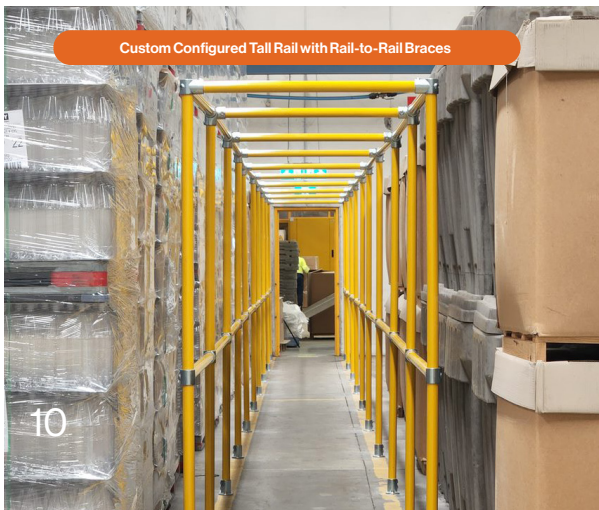

Surex Pedestrian 'Tall-Rail' Kits Black and Galvanised



End Section Kit 'Tall-Rail'



- Includes: 1 x End Post, 4 x Rails
- Rails: Ø48 x 2160(L)mm (overall length 2200mm)
- Post: Ø48 x 2160mm (overall height 2200mm)

code	COLOUR	OVERALL SIZE	1+
11-MTRE-B	Black	2200(H) x 2200(L)mm - 4 Rails	\$699.00 / set
11-MTRE-G	Gal	2200(H) x 2200(L)mm - 4 Rails	\$449.00 / set



Corner Section Kit 'Tall-Rail'



- Includes: 1x Corner post, 4 x Rails
- Rails: Ø48 x 2160(L)mm (overall length 2200mm)
- Post: Ø48 x 2160mm (overall height 2200mm)

code	colour	overall size	1+
11-MTRC-B	Black	2200(H) x 2200(L)mm - 4 Rails	\$699.00 / set
11-MTRC-G	Gal	2200(H) x 2200(L)mm - 4 Rails	\$449.00 / set



Mid Section Kit 'Tall-Rail'



- Includes: 1x Intermediate Post, 4 x Rails
- Rails: Ø48 x 2160(L)mm (overall length 2200mm)
- Post: Ø48 x 2160mm (overall height 2200mm)

code	colour	overall size	1+
11-MTRM-B	Black	2200(H) x 2200(L)mm - 4 Rails	\$699.00 / set
11-MTRM-G	Gal	2200(H) x 2200(L)mm - 4 Rails	\$449.00 / set

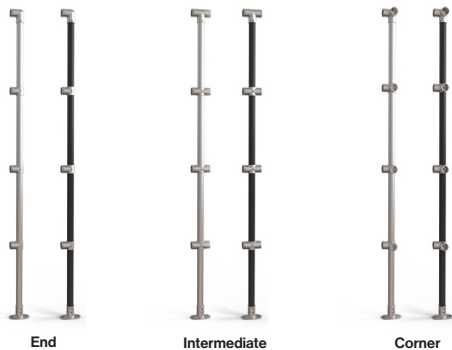

End

Intermediate

Corner



Rail to Wall Brace



Rail to Rail Brace

Post, Rail, Brace & Fastener Kits 'Tall Rail'



- Includes post and fittings
- Size: Ø48 x 2200mm (overall)

code	description	1+
11-MTR-PE-B	Black End Post with fittings	\$295.00 / set
11-MTR-PE-G	Galvanised End Post with fittings	\$235.00 / set
11-MTR-PM-B	Black Intermediate Post with fittings	\$295.00 / set
11-MTR-PM-G	Galvanised Intermediate Post with fittings	\$235.00 / set
11-MTR-PC-B	Black Corner Post with fittings	\$295.00 / set
11-MTR-PC-G	Galvanised Corner Post with fittings	\$235.00 / set
11-MH-PCRAIL-B	Black Horizontal Rail - (ø48mm x 2160mm)	\$129.90 / ea
-STEEL40NBx2160	Galvanised Horizontal Rail - (ø48mm x 2160mm)	\$79.90 / ea
11-MTR-R2R-B	Black Rail To Rail Brace - 1000mm	\$175.00 / set
11-MTR-R2R-G	Galvanised Rail To Rail Brace - 1000mm	\$139.00 / set
11-MTR-W2R-B	Black Wall To Rail Brace - 1000mm	\$175.00 / set
11-MTR-W2R-G	Galvanised Wall To Rail Brace - 1000mm	\$139.00 / set
08-GSB1275X2	M12 x 75mm Galvanised Screw Bolt - Set of 2 (Requires 1 Set of Fasteners Per Base Plate)	\$4.95 / set

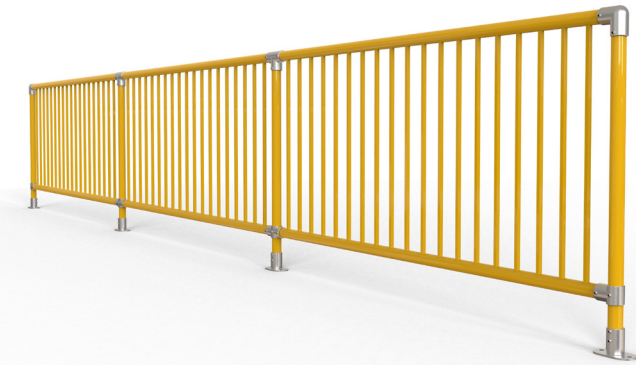

Available with 3 different connection types



Surex Modular Fencing Panels

- Heavy duty galvanised steel
- All fittings heavy duty cast galvanised steel
- Compliant handrail height
- Custom colours available
- Perfect for footpaths and pedestrian paths that require extra safety and security

Surex Modular Pedestrian Fencing Kits (Yellow)

code	description	1+
11-MPFE-Y	End Section: 1100(H)mm x 2050(L)mm (end post & fence panel)	\$895.00 / ea
11-MPFM-Y	Mid Section: 1100(H)mm x 2050(L)mm (mid post & fence panel)	\$895.00 / ea
11-MPFC-Y	Corner Section: 1100(H)mm x 2050(L)mm (corner post & fence panel)	\$895.00 / ea
11-MPF-PE-Y	End Post: 1100(H)mm	\$179.00 / ea
11-MPF-PM-Y	Mid Post: 1100(H)mm	\$179.00 / ea
11-MPF-PC-Y	Corner Post: 1100(H)mm	\$179.00 / ea



End, Mid and Corner Posts



Surex Modular Pedestrian Fencing Kits (Black)

code	description	1+
11-MPFE-B	End Section: 1100(H)mm x 2050(L)mm (end post & fence panel)	\$895.00 / ea
11-MPFM-B	Mid Section: 1100(H)mm x 2050(L)mm (mid post & fence panel)	\$895.00 / ea
11-MPFC-B	Corner Section: 1100(H)mm x 2050(L)mm (corner post & fence panel)	\$895.00 / ea
11-MPF-PE-B	End Post: 1100(H)mm	\$179.00 / ea
11-MPF-PM-B	Mid Post: 1100(H)mm	\$179.00 / ea
11-MPF-PC-B	Corner Post: 1100(H)mm	\$179.00 / ea



End, Mid and Corner Posts



Surex Modular Pedestrian Fencing Kits (Gal)

code	description	1+
11-MPFE-G	End Section: 1100(H)mm x 2050(L)mm (end post & fence panel)	\$765.00 / ea
11-MPFM-G	Mid Section: 1100(H)mm x 2050(L)mm (mid post & fence panel)	\$765.00 / ea
11-MPFC-G	Corner Section: 1100(H)mm x 2050(L)mm (corner post & fence panel)	\$765.00 / ea
11-MPF-PE-G	End Post: 1100(H)mm	\$149.00 / ea
11-MPF-PM-G	Mid Post: 1100(H)mm	\$149.00 / ea
11-MPF-PC-G	Corner Post: 1100(H)mm	\$149.00 / ea

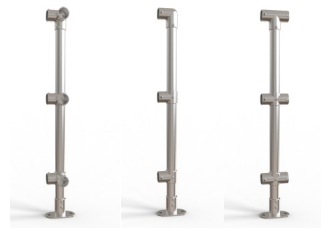

End, Mid and Corner Posts



Surex Pedestrian Rail Fixings and Components



Surex Pedestrian Rail Fixings and Components

■ To suit 48mm OD Pipe

code	description	1+
-101D48	Short Tee	\$27.90 / ea
-104D48	Long Tee	\$43.90 / ea
-116D48	3-Way Mid Corner	\$36.90 / ea
-119D48	2-Way Cross Clamp	\$41.90 / ea
-123D48	Variable Acute Elbow (40° - 70°)	\$65.90 / ea
-124D48	Variable Obtuse Elbow (15° - 60°)	\$54.90 / ea
-125D48	2-Way Elbow 90°	\$33.90 / ea
-128D48	3-Way Elbow	\$52.50 / ea
-130D48	Variable Cross Over (30° - 45°)	\$69.90 / ea
-131D48	Wall Flange	\$37.90 / ea
-132D48	Base Plate	\$59.90 / ea
-134D48	In-ground Post Socket	\$115.00 / ea
-137D48	Add-On Cross Over	\$88.00 / ea
-143D48	Handrail Through Bracket	\$37.90 / ea
-146D48	Wall Mount Post Bracket	\$62.90 / ea
-150D48	DDA End-to-End Internal Joint	\$29.90 / ea
-152D48	Slope Base Flange (0° - 11°)	\$66.90 / ea
-158D48	6-Way Crossover	\$66.90 / ea
-161D48	2-Way Offset Cross Over	\$31.90 / ea
-166D48	Adjustable Angle Knuckle	\$76.90 / ea
-169M	Plate connector	\$27.50 / ea
-169D48	Swivel Bracket (not for base plate use)	\$66.90 / ea
-173D48	Single Swivel T Combination	\$44.90 / ea
-176D48	5-Way Mid Cross Tee	\$49.90 / ea
-197D48	Sign/ Kick Plate Clamp	\$33.90 / ea
-198D48	Kick Plate Bracket	\$66.90 / ea
-199D48	Gate Striker/Flush Lug	\$29.90 / ea
-745D48	DDA Handrail Joiner Wall Bracket	\$88.00 / ea
-746D48	DDA Handrail Saddle Wall Bracket	\$55.90 / ea
-748C42	DDA Offset Handrail Saddle	\$55.90 / ea
-750D48	DDA Assist Expanding Fitting	\$69.90 / ea
-751D48	DDA Handrail Saddle	\$55.90 / ea
08-GSB1275X2	M12 x 75mm Galvanised Screw Bolt - Set of 2 (Requires 1 Set of Fasteners Per Base Plate)	\$4.95 / set

Surex Pedestrian Rail Gates



Self-Closing Gate Kits Safety Yellow

- 900mm wide - Fixed width
- 1200mm wide - Adjustable - Can be cut to size on site.

code	description	1+
11-MHRG-900	Self Closing Gate - 900mm	\$449.00 / ea
11-MHRG-1200	Self Closing Gate - 1200mm	\$549.00 / set
11-MHRG-STRIKER	Gate Striker	\$29.90 / ea

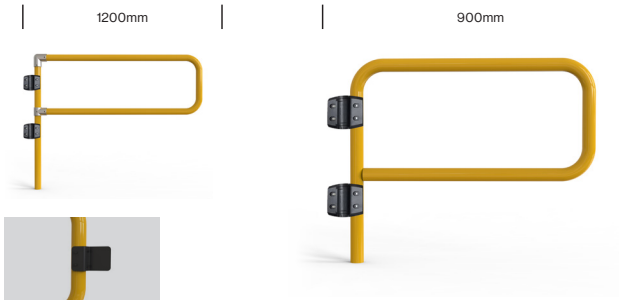

Gate Striker

Self-Closing Gate Kits Galvanised

- 900mm wide - Fixed width
- 1200mm wide - Adjustable - Can be cut to size on site

code	description	1+
11-MHRG-G-900	Self Closing Gate - 900mm	\$399.00 / set
11-MHRG-G-1200	Self Closing Gate - 1200mm	\$499.00 / set
11-MHRG-STRIKER	Gate Striker	\$29.90 / ea

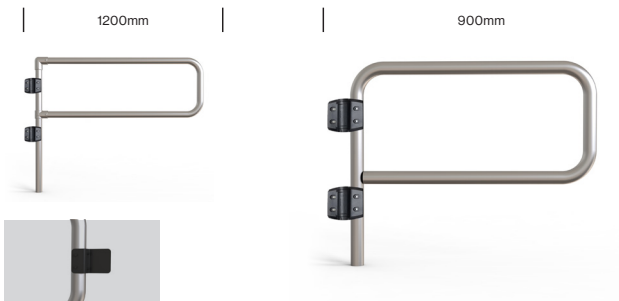

Gate Striker

Self-Closing Gate Kits Black

- 900mm wide - Fixed width
- 1200mm wide - Adjustable - Can be cut to size on site

code	description	1+
11-MHRG-B-900	Self Closing Gate - 900mm	\$489.00 / ea
11-MHRG-B-1200	Self Closing Gate - 1200mm	\$599.00 / ea
11-MHRG-STRIKER	Gate Striker	\$29.90 / ea

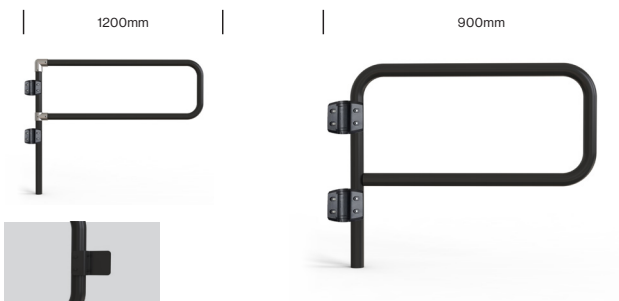

Gate Striker

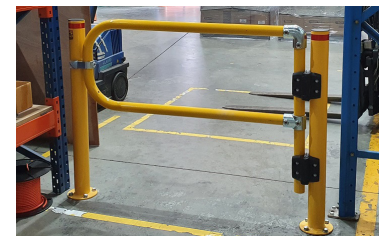

Surex 'Recessed Rail' Barrier Features

1. Premium safety yellow powder coat
2. Optional compliant handrail
3. Heavy wall steel post & rail
4. Recessed rail attachment for extra strength
5. 4 size options
6. Optional kick plate
7. Non-trip base plates
8. Full galvanised - no rust!

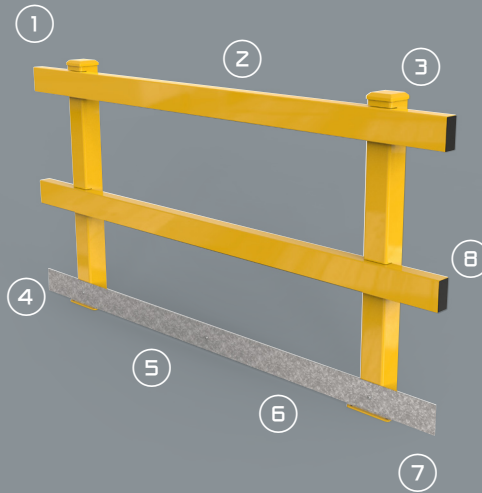

Pictured: 2m 'Recessed Rail' with Kick Plate

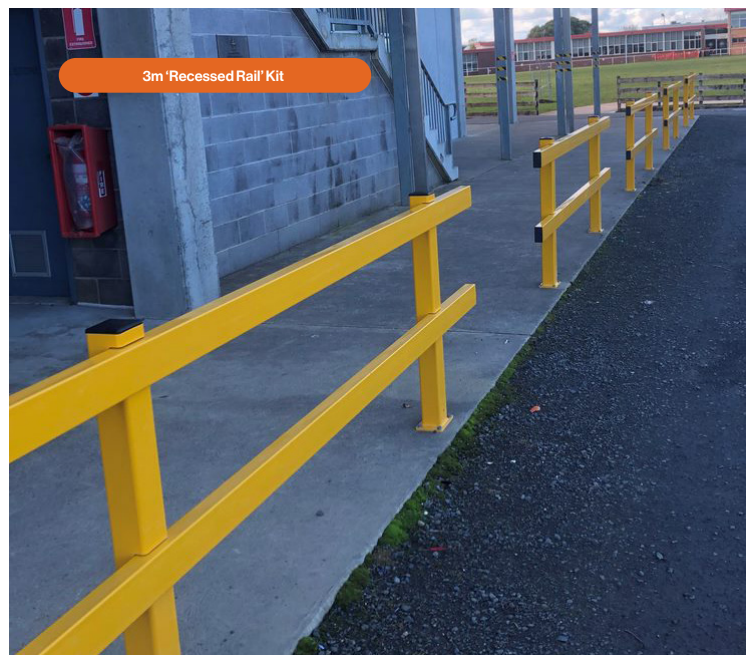
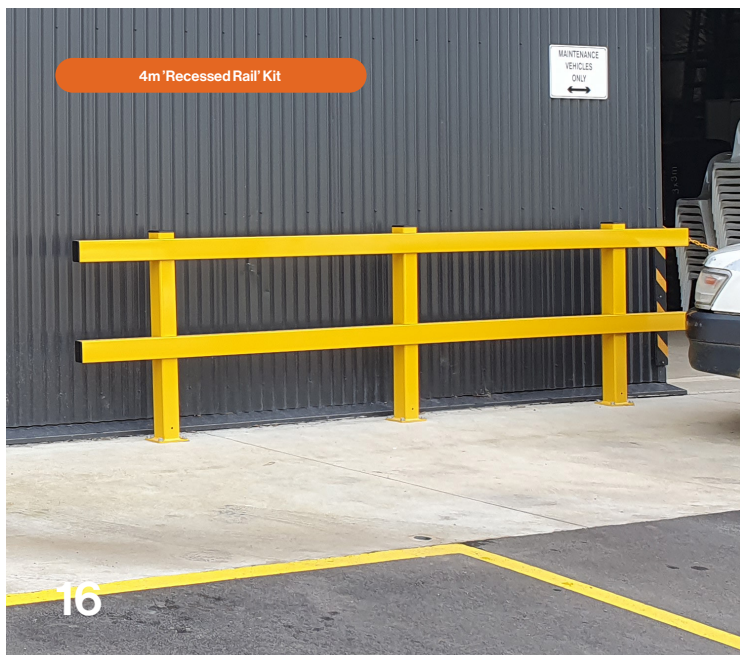

Surex 'Recessed Rail' Warehouse Barriers



Surex 'Recessed Rail' Warehouse Barrier (Powder Coated Safety Yellow)

- Heavy Wall Galvanised Steel Posts & Rails powder coated Safety Yellow
- Optional Kick Plate Available
- Post Height: 1000mm
- Rail Height: 970mm
- Custom colours available, please enquire
- Structural Compliance Certificate available. Rated to 30kN impact force capacity, absorbing 934.2 J kinetic energy.

code	description	1+
12-SWB1	1m Post & Rail Kit	\$889.00 / set
12-SWB2	2m Post & Rail Kit	\$999.00 / set
12-SWB3	3m Post & Rail Kit	\$1,199.00 / set
12-SWB4	4m Post & Rail Kit (3 posts)	\$1,599.00 / set
08-GSB1275X4	M12 x 75mm Galvanised Screw Bolt - Set of 4 (Require 1 set of fixings per base plate)	\$9.90 / set

Optional Kick Plate

- 100mm High
- Galvanised Steel Plate

code	description	1+
12-SWBKP1	1m Kick Plate	\$159.00 / ea
12-SWBKP2	2m Kick Plate	\$299.00 / ea
12-SWBKP3	3m Kick Plate	\$429.00 / ea
12-SWBKP4	4m Kick Plate	\$519.00 / ea

Optional Hand Rail

- Galvanised Steel Rail

code	description	1+
12-SWBHR1	1m Hand Rail Kit	\$149.00 / ea
12-SWBHR2	2m Hand Rail Kit	\$189.00 / ea
12-SWBHR3	3m Hand Rail Kit	\$229.00 / ea
12-SWBHR4	4m Hand Rail Kit	\$339.00 / ea

NEW

'Recessed Rail' Roller Gate

- Height: 1054mm (to top of handles), 954mm (to top of rail)
- Overall Length 4m
- Opening Length 3.3m
- Powder Coat Colours: Yellow & Black
- 2 Mounting Options – Mount to Area Safe's Recessed Rail or Mount to an existing wall

Recessed Rail Mount

code	description	1+
12-RRRG25-Y	2.5 metres Yellow	\$1,860.00 / ea
12-RRRG25-B	2.5 metres Black	\$1,860.00 / ea
12-RRRG4-Y	4 metres Yellow	\$1,990.00 / ea
12-RRRG4-B	4 metres Black	\$1,990.00 / ea

Wall Mount

code	description	1+
12-WMRG25-Y	2.5 metres Yellow	\$1,860.00 / ea
12-WMRG25-B	2.5 metres Black	\$1,860.00 / ea
12-WMRG4-Y	4 metres Yellow	\$1,990.00 / ea
12-WMRG4-B	4 metres Black	\$1,990.00 / ea

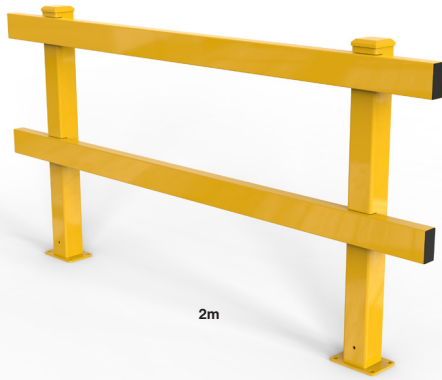

2m



1m



3m with Kick Plate



4m



2m with Handrail



Recessed Rail Roller Gate - 4m (See Page 93)



3m Recessed Rail Kit (See Page 93)



3m Recessed Rail Kit (See Page 93)



Recessed Rail Roller Gate - 4m (See Page 93)

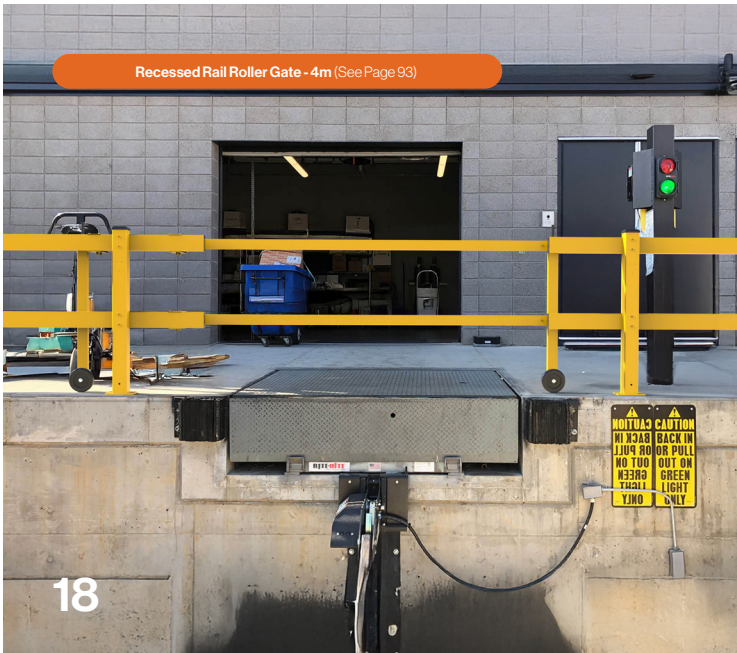

4m Recessed Rail Kit (See Page 93)



Surex 'High Recessed Rail' Warehouse Barriers

NEW

Surex 'High Recessed Rail' Warehouse Barriers

- Heavy Wall Galvanised Steel Posts & Rails Powder Coated Safety Yellow
- Post Height: 3200mm
- Custom Colours and Sizes available - please enquire

code	description	1+
12-SHRRWB4	4m long — Post & Rail Kit	\$4,490.00 / ea
12-SHRRWB6	6m long — Post & Rail Kit	\$5,750.00 / ea

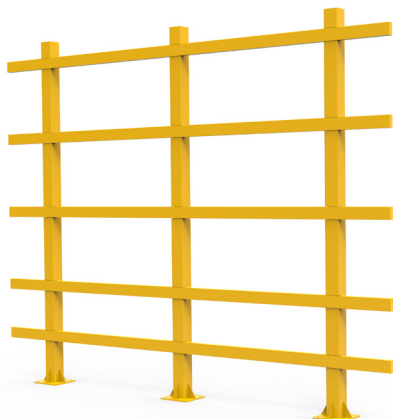

4m Long



6m Long



Surex Polymer Flexible Warehouse Barrier

See Page 103



Extra Heavy Duty Swing Gate - Black



Recessed Rail Pedestrian Gates - Alarmed



Recessed Rail Pedestrian Gates - Audio Alarm



2m Recessed Rail Kit with Kickplate (See Page 93)



Recessed Rail Pedestrian Gates Alarmed

Surex Pedestrian Gate Features

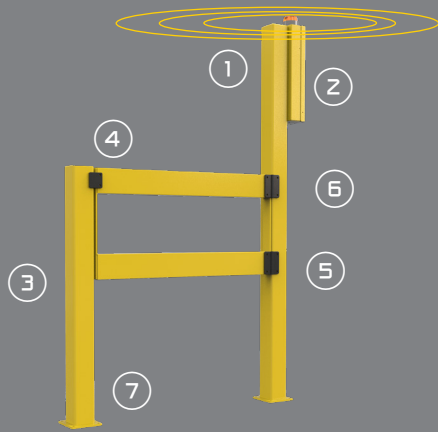

- 1. Warning light (visual)
- 2. Warning alarm (audio)
- 3. High visibility safety yellow powder coat
- 4. Heavy duty hinges
- 5. Heavy duty gate stopper
- 6. 1.66m high post for added safety visibility
- 7. Heavy duty 8mm base plates

Recessed Rail Pedestrian Gates Alarmed

- Extra Heavy Duty Galvanised Steel Construction
- Options of standard gate, gate with visual alarm, gate with audio alarm and gate with visual and audio alarm
- Standard Gate Size: 1090(W) x 1006(H)mm (Gate Opening Width: 859mm)
- Alarmed Gate Size: 1090(W) x 1665(H)mm (Gate Height: 1006mm, Gate Opening Width: 859mm)
- Alarm is activated upon opening of gate
- Alarmed Gates use 8x 'D' Batteries (Not included - client to supply)

code	description	1+
09-RRPGS	Standard Gate - No Alarm	\$1,550.00 / ea
09-RRPGAA	Gate with Audio Alarm	\$2,330.00 / ea
09-RRPGVA	Gate with Visual Alarm	\$2,330.00 / ea
09-RRPGVAA	Gate with Visual and Audio Alarm	\$2,380.00 / ea
09-WMAB-VA	Wall Mount Alarm Box (Visual & Audio)	\$699.00 / ea
08-GSB1275X8	M12 x 75mm Galvanised Screw Bolt - Set of 8	\$19.80 / set

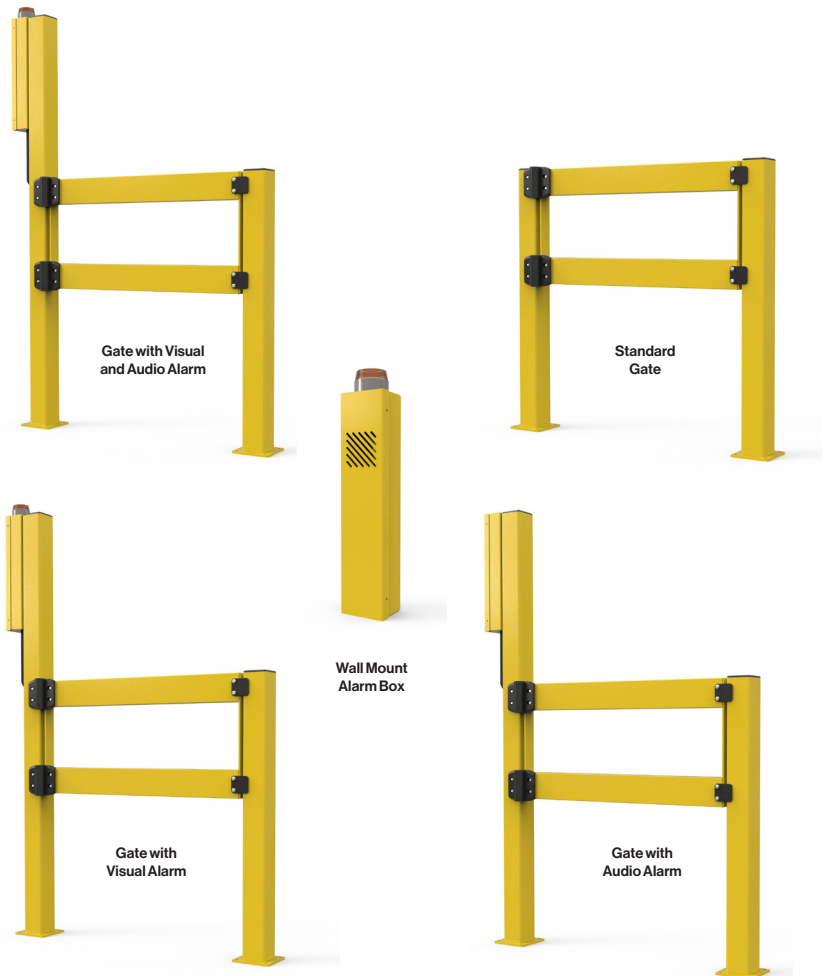

W-Beam Guard Rails Galvanised

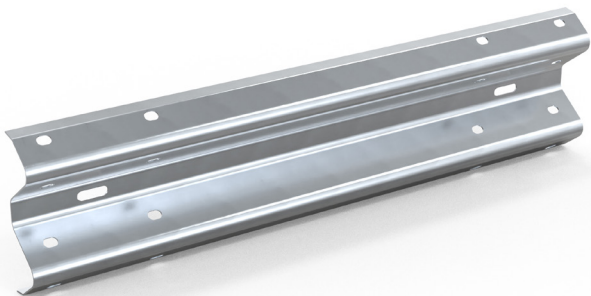

W-Beam Guard Rails Galvanised

- Galvanised finish

code	description	1+
12-WBR1	1m - W-Beam Rail (use 2 posts)	\$125.00 / ea
12-WBR2	2m - W-Beam Rail (use 2 posts)	\$249.00 / ea
12-WBR4	4m - W-Beam Rail (use 3 posts)	\$385.00 / ea
12-WB-SB	Splice Bolt/Nut (use 8 per join)	\$5.40 / ea

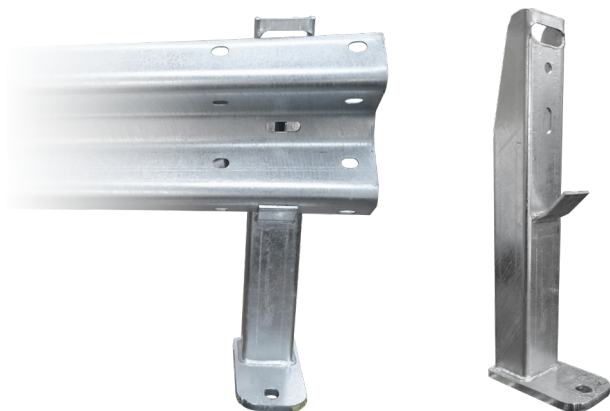

725mm

W-Beam Posts Galvanised

- Galvanised finish
- 1 person install design
- Handle for easier carrying
- W-Beam Holder Bracket for easier installation

code	description	1+
12-WBCP	620mm - C-Post, Surface Mount	\$215.00 / ea
12-WBCP-D	1140mm - C-Post, Surface Mount (double height)	\$329.00 / ea
12-WBCPIG	1225mm - C-Post, In-ground	\$289.00 / ea
12-WBCPIG-D	1850mm - C-Post, In-ground (double height)	\$329.00 / ea
12-WB-PB	Post Bolt/Nut	\$5.40 / ea
12-WBPF1	Fasteners to suit Standard Height W-Beam Post M20x160mm Galvanised Through Bolt	\$10.00 / ea
12-WBPF2	Fasteners to suit Double Height W-Beam Post M20x160mm Galvanised Through Bolt (Set of 2)	\$20.00 / set

Terminal Options

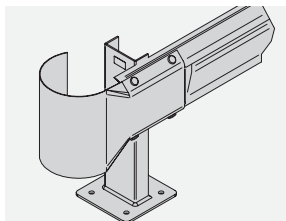

CarPark C-End

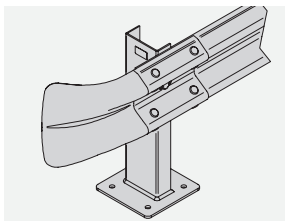

Fish Tail

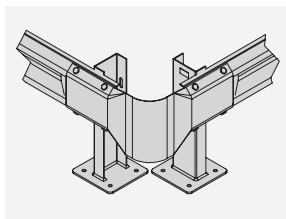

External Corner

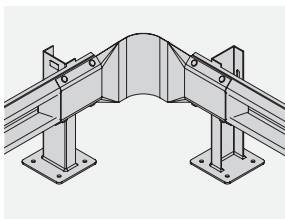

Internal Corner

W-Beam Terminals Galvanised

- Galvanised finish

code	description	1+
12-WBCE	Car Park C-End, Gal (use 4 splice bolts)	\$189.00 / ea
12-WBFT	Fish Tail - Gal (use 8 splice bolts)	\$189.00 / ea
12-WBFCE	90° Corner - External, Gal (use 8 splice bolts total)	\$365.00 / ea
12-WBFCEI	90° Corner - Internal, Gal (use 8 splice bolts total)	\$365.00 / ea
12-WB-SB	Splice Bolt/Nut	\$5.40 / ea

W-Beam Guard Rails Yellow



W-Beam Guard Rails Yellow

■ Yellow finish

code	description	1+
12-WBR1-Y	1m - W-Beam Rail (use 2 posts) - Yellow	\$180.00 / ea
12-WBR2-Y	2m - W-Beam Rail (use 2 posts) - Yellow	\$355.00 / ea
12-WBR4-Y	4m - W-Beam Rail (use 3 posts) - Yellow	\$595.00 / ea
12-WB-SB	Splice Bolt / Nut (use 8 per join)	\$5.40 / ea



W-Beam Posts Yellow

- Yellow finish
- 1 person install design
- Handle for easier carrying
- W-Beam Holder Bracket for easier installation

code	description	1+
12-WBCP-Y	620mm - C-Post, Surface Mount (standard size)	\$259.00 / ea
12-WBCP-D-Y	1140mm - C-Post, Surface Mount (double height)	\$409.00 / ea
12-WBCPIG-Y	1225mm - C-Post, In-ground	\$369.00 / ea
12-WBCPIG-D-Y	1850mm - C-Post, In-ground (double height)	\$409.00 / ea
12-WB-PB	Post Bolt / Nut	\$5.40 / ea
12-M2075X4	Ground Fixings - Gal Sleeve Anchor M20 x 75mm (Set of 4)	\$24.90 / set

Terminal Options

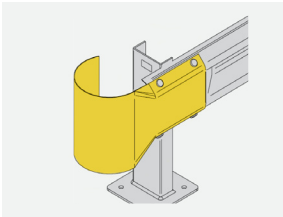

CarPark C-End

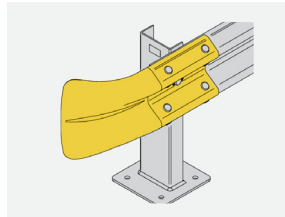

Fish Tail

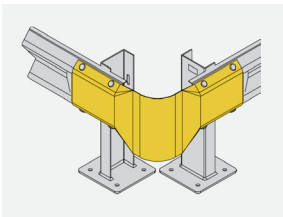

External Corner

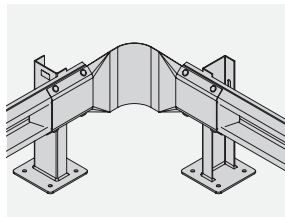

Internal Corner

W-Beam Terminals Yellow

■ Yellow finish

code	description	1+
12-WBCE-Y	Car Park C-End, Yellow (use 4 splice bolts)	\$259.00 / ea
12-WBFT-Y	Fish Tail - Yellow (use 8 splice bolts)	\$259.00 / ea
12-WBFCE-Y	90° Corner - External, Yellow (use 8 splice bolts total)	\$425.00 / ea
12-WBFCE-Y	90° Corner - Internal, Yellow (use 8 splice bolts total)	\$425.00 / ea
12-WB-SB	Splice Bolt/Nut	\$5.40 / ea



W-Beam Guard Rail - Galvanised Surface Mounted with Fish Tail (See Page 98)



W-Beam Guard Rail - Galvanised In-ground post (See Page 98) with Car Park C-End - Yellow (See Page 99)



W-Beam Guard Rail - Yellow (See Page 99) Surface Mounted Posts (See Page 98)



W-Beam Guard Rail - Galvanised with Car Park C-End (See Page 98)



W-Beam Guard Rail - Galvanised with Car Park C-End (See Page 98)



W-Beam Guard Rail - Galvanised Surface Mounted with Internal Corners and Car Park C-End (See Page 99)

W-Beam Guard Rails

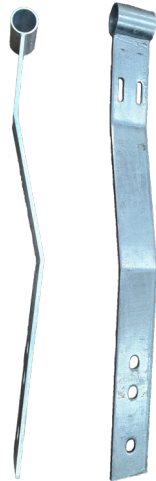

W-Beam Hand Rails

- Galvanised finish

code	description	1+
12-WHR4	4m - W-Beam Hand Rail	\$149.90 / ea
12-WHR2.5	2.5m - W-Beam Hand Rail	\$89.90 / ea
12-WHRC	Single Crank Handrail (1 per post)	\$119.00 / ea
12-WHRCM	Handrail Crank to Suit Mesh Panel	\$119.00 / ea
12-WHRF	Fixings Set (1 per posts)	\$3.90 / ea
12-WHRJ	Hand Rail Straight Joiner	\$24.90 / ea
12-WHREC	Hand Rail End Cap	\$8.90 / ea



W-Beam Anti Climb Mesh

- Galvanised finish
- Kit includes: mesh panel, steel angle, fixings to suit
- Mesh & angle can be cut down on site

code	description	1+
12-WMK24	Anti-Climb Mesh Panel Kit 2400x900(H)mm	\$699.00 / kit

W-Beam Configurations

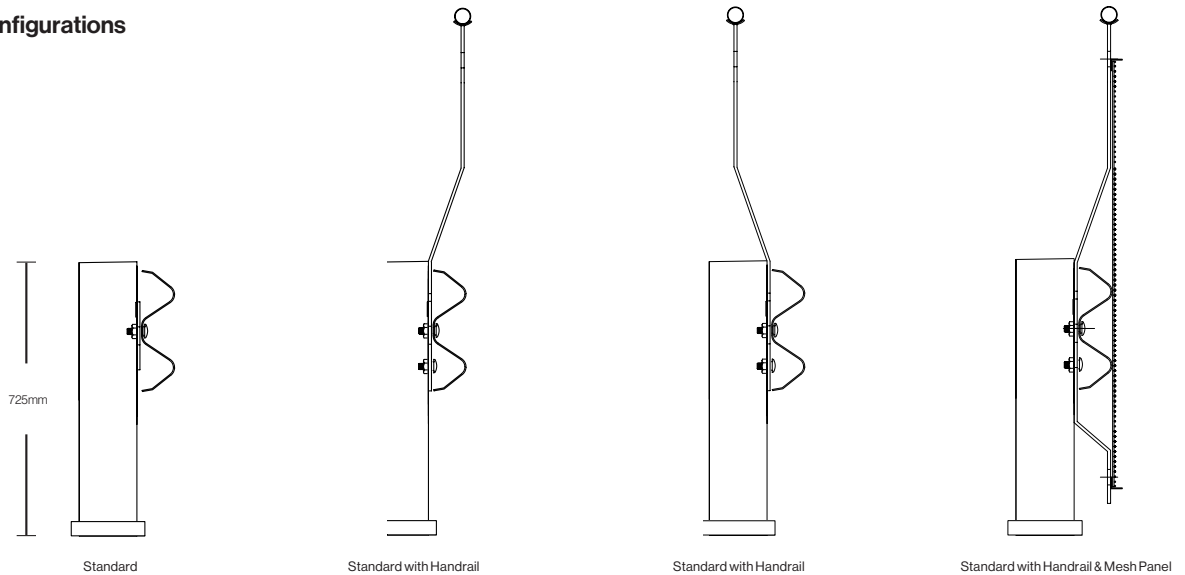

Surex Polymer Flexible Warehouse Barrier - End & Mid Sections



Surex Polymer Flexible Warehouse Barrier - End & Corner Sections



Surex Polymer Flexible Warehouse Barrier - End & Mid Sections



Surex Polymer Flexible Warehouse Barrier - End Section & End Post



Surex Polymer Flexible Warehouse Barrier - End & Corner Sections



Flexible Polymer Warehouse Barriers



All Kits comes with 1 post and 3 rails



Corner post



Middle post



End post



Example configurations

NEW

Surex Polymer Flexible Warehouse Barrier

Protect critical infrastructure and personnel with the Surex Polymer Flexible Warehouse Barrier. Designed for demanding warehouse environments, this modular system absorbs forklift impact without damaging floors, preserving your concrete and safety investment.

- Flexible polymer design absorbs impact without pulling out anchor bolts or damaging concrete
- Modular system easily configures to suit any warehouse layout or application
- Provides low-level protection for racking, walls, and pedestrian zones
- Bright safety-yellow finish enhances visibility and reduces collision risk

code	description	1+
12-PFWB-ES	End Section 2180(L) x 1100(H) x 180(W)mm (Kit includes 1 end post & 3 horizontal rails)	\$725.00 / kit
12-PFWB-MS	Mid Section 2180(L) x 1100(H) x 180(W)mm (Kit includes 1 mid post & 3 horizontal rails)	\$725.00 / kit
12-PFWB-CS	Corner Section 2180(L) x 1100(H) x 180(W)mm (Kit includes 1 corner post & 3 horizontal rails)	\$725.00 / kit
12-PFWB-EP	End Post 1100(H) x 180(dia)mm	\$349.00 / ea
12-PFWB-MP	Mid Post 1100(H) x 180(dia)mm	\$349.00 / ea
12-PFWB-CP	Corner Post 1100(H) x 180(dia)mm	\$349.00 / ea

Surex Polymer Flexible Warehouse Barrier Features

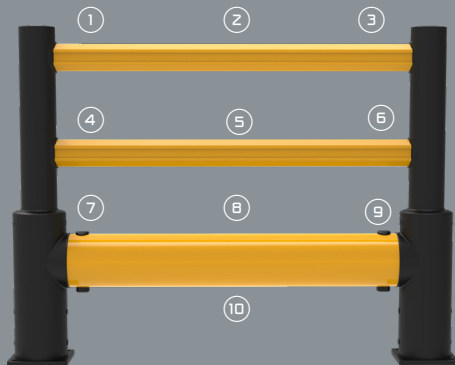

1. Impact-Absorbing Design
Dual-layer build cushions and disperses low-speed impacts to protect people and assets.
2. Flexible Polymer Construction
High-grade polymer flexes on impact, reducing floor and anchor damage versus rigid barriers.
3. Internal Rib Reinforcement
Internal ribs boost strength while maintaining energy absorption.
4. Heavy-Duty Crossbar Protection
Oversized rails create a solid divide between pedestrians and vehicles in busy zones.
5. Visual Safety Cue
High-visibility yellow aids driver and pedestrian awareness.
6. Modular Layout Options
Mix and match components to fit any warehouse or factory layout.
7. Floor-Friendly Anchoring
Rubber energy buffer and fixed bolts minimise concrete damage on impact.
8. Forklift-Tested Durability
Withstands direct forklift hits, absorbing thousands of joules without permanent set.
9. Optimised for Low-Level Hazards
– Ideal height blocks pallet jacks and forks from equipment and walkways.
10. Warehouse Safety Upgrade
Smart add-on for logistics and manufacturing to cut accident-related downtime.

Driver Safe Zone - Modular Pedestrian Rail Kit

DRIVER
SAFE
ZONE



Custom Driver Safe Zone Kit - Recessed Rail & Alarmed Gate

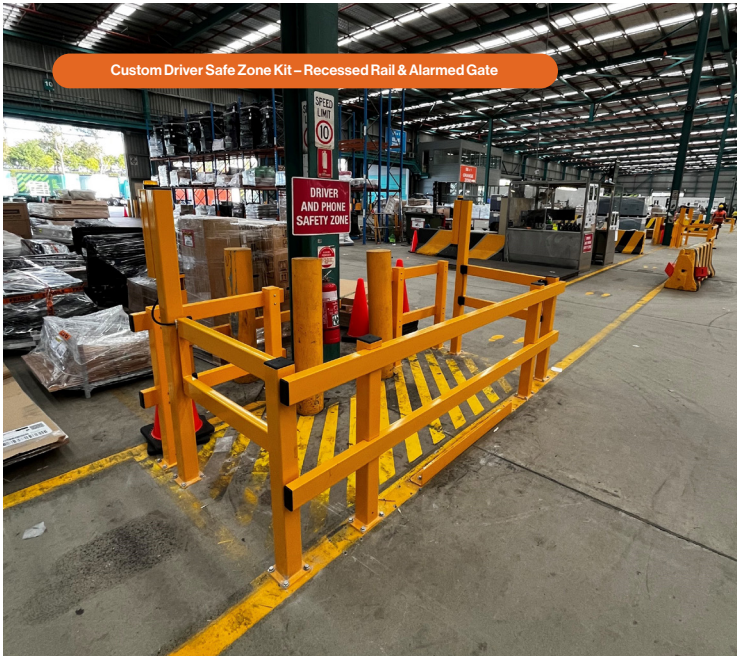

Custom Driver Safe Zone Kit - Modular Rail & Alarmed Gate

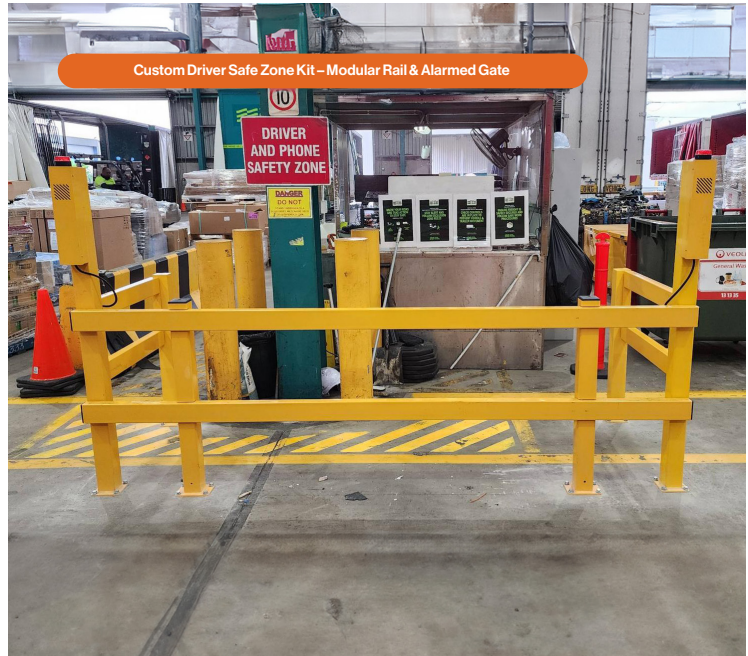

Custom Driver Safe Zone Kit - Modular Rail & Alarmed Gate



Custom Driver Safe Zone Kit - Modular Rail & Alarmed Gate





Driver Safe Zones Recessed Rail Kit (Heavy Duty)

- Overall Footprint: 3000mm x 2000mm
- Kit Includes:
 - 3 x 2m Recessed Rail
 - Standard Recessed Rail Gate
 - 2x 2m Aluminium Benches (Optional)

code	description	1+
12-DSZ-RR	Driver Safe Zone - Recessed Rail Kit	\$4,250.00 / ea
12-DSZ-RRB	Driver Safe Zone - Recessed Rail Kit (With Benches)	\$4,940.00 / ea
08-GSB1275X4	M12 x 75mm Galvanised Screw Bolt - Set of 4 (Requires 1 Set of Fasteners Per Base Plate)	\$9.90 / set



Driver Safe Zones Double Rail U-Bollard Kit (Pedestrian Duty)

- Overall Footprint : 3200mm x 2200mm
- Kit Includes:
 - 3 x 2m Double Rail U-Bollard
 - 2 x 90mm Yellow Bollards
 - 1x 900mm Pedestrian Gate
 - 2x 2m Aluminium Benches (Optional)

code	description	1+
12-DSZ-DRU	Driver Safe Zones - Double Rail U-Bollard Kit	\$2,399.00 / ea
12-DSZ-DRUB	Driver Safe Zones - Double Rail U-Bollard Kit (With Benches)	\$3,169.00 / ea
08-GSB1275X4	M12 x 75mm Galvanised Screw Bolt - Set of 4 (Requires 1 Set of Fasteners Per Base Plate)	\$9.90 / set



Driver Safe Zones Modular Pedestrian Rail Kit (Pedestrian Duty)

- Overall Footprint : 3200mm x 2200mm
- Kit Includes:
 - 3 x 2.2m Modular Rail Kits
 - 1x 900mm Pedestrian Gate
 - 2x 2m Aluminium Benches (Optional)

code	description	1+
12-DSZ-MPR	Driver Safe Zone - Modular Pedestrian Rail Kit	\$1,890.00 / ea
12-DSZ-MPRB	Driver Safe Zone - Modular Pedestrian Rail Kit (With Benches)	\$2,690.00 / ea
08-GSB1275X2	M12 x 75mm Galvanised Screw Bolt - Set of 2 (Requires 1 Set of Fasteners Per Base Plate)	\$4.95 / set





V typesocket

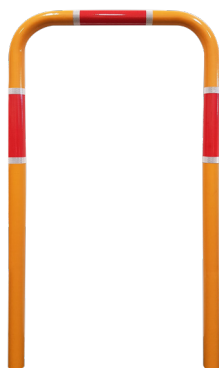

Holding Rail

- Class / reflective to RMS specs
- Size: 800mm x 1400mm
- Post Ø60mm (OD)
- Weight: 15kg

code	description	1+
09-HRR/R	Holding rail	\$269.00 / ea
10-VLOCK	V type socket (2 required)	\$49.90 / ea



U-Bar Bollards 48mm Galvanised

- Length: 850mm
- Height: 800mm

code	description	1+
10-SHBIKE-G	Galvanised finish	\$179.00 / ea
10-SHBIKE	Powder Coated Black	\$249.00 / ea
10-SHBIKE-Y	Powder Coated Yellow	\$249.00 / ea
08-GSB1275X8	M12 x 75mm Galvanised Screw Bolt - Set of 8	\$19.80 / set



U-Bar Bollards 90mm Heavy Duty - Galvanised

- Galvanised finish
- Heavy 5mm wall thickness

code	description	1+
09-UB10-BP	1000(L) x 700(H)mm Base Plate, 31kg	\$829.00 / ea
09-UB10-IG	1000(L) x 1200(H)mm In-ground, 31kg	\$889.00 / ea
09-UB15-BP	1500(L) x 700(H)mm Base Plate, 36kg	\$990.00 / ea
09-UB15-IG	1500(L) x 1200(H)mm In-ground, 36kg	\$1,095.00 / ea
09-UB20-BP	2000(L) x 700(H)mm Base Plate, 41kg	\$1,130.00 / ea
08-GSB1275X8	M12 x 75mm Galvanised Screw Bolt - Set of 8	\$19.80 / set



U-Bar Bollards 90mm Heavy Duty - Galvanised Powder Coated Yellow

- Galvanised finish - Powder Coated Yellow
- Heavy 5mm wall thickness

code	description	1+
09-UBY10-BP	1m Long U Bollard Surface Mount - Size: 1000(L) x 700(H)mm, 31kg	\$919.00 / ea
09-UBY10-IG	1m Long U Bollard In-ground - Size: 1000(L) x 1200(H)mm, 31kg	\$999.00 / ea
09-UBY15-BP	1.5m Long U Bollard Surface Mount - Size: 1500(L) x 700(H)mm, 36kg	\$1,075.00 / ea
09-UBY15-IG	1.5m Long U Bollard In-ground - Size: 1500(L) x 1200(H)mm, 36kg	\$1,229.00 / ea
09-UBY20-BP	2m Long Mount U Bollard Surface - Size: 2000(L) x 700(H)mm, 41kg	\$1,239.00 / ea
08-GSB1275X8	M12 x 75mm Galvanised Screw Bolt - Set of 8	\$19.80 / set

Double Rail U-Bollards

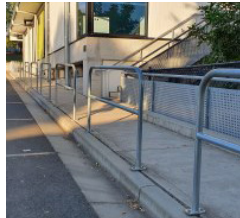

Double Rail U Bollards Bolt Down - Galvanised

■ Size: Ø48 x 1040(H)mm

code	description	1+
09-DRB10-BP	1m Long Double Rail U Bollard Surface Mount	\$219.00 / ea
09-DRB15-BP	1.5m Long Double Rail U Bollard Surface Mount	\$249.00 / ea
09-DRB20-BP	2m Long Double Rail U Bollard Surface Mount	\$295.00 / ea
08-GSB1275X4	M12 x 75mm Galvanised Screw Bolt - Set of 4	\$9.90 / set

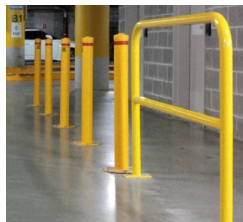

Double Rail U Bollards Bolt Down - Galvanised Powder Coated Yellow

■ Size: Ø48 x 1040(H)mm

code	description	1+
09-DRB10-BP-Y	1m Long Double Rail U Bollard Surface Mount	\$319.00 / ea
09-DRB15-BP-Y	1.5m Long Double Rail U Bollard Surface Mount	\$379.00 / ea
09-DRB20-BP-Y	2m Long Double Rail U Bollard Surface Mount	\$459.00 / ea
08-GSB1275X4	M12 x 75mm Galvanised Screw Bolt - Set of 4	\$9.90 / set



Double Rail U Bollards In-ground

■ Galvanised finish

■ Size: Ø48 x 1340(H)mm overall

code	description	1+
09-DRB10-IG	1m Long In-ground Double Rail U Bollard	\$375.00 / ea
09-DRB15-IG	1.5m Long In-ground Double Rail U Bollard	\$445.00 / ea
09-DRB20-IG	2m Long In-ground Double Rail U Bollard	\$499.00 / ea

Industrial Expanding Barriers & Belt Barriers

See Pages 136-147



Heavy Duty Industrial Swing Gate Manual

- 1. Heavy duty ball-bearing hinge
- 2. Reflective strips & standard or customised messages also available
- 3. Aluminium beam for easy opening & closing
- 4. 2m, 3m or 4m length options
- 5. Wall, post or bollard mounting options
- 6. Galvanised steel support braces for added support
- 7. Premium powder coat finish (yellow or black)
- 8. Gate receiver also available

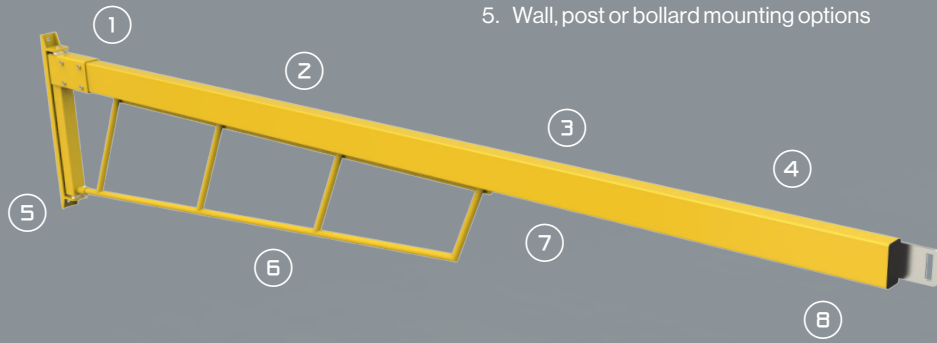

Heavy Duty Industrial Swing Gate - Manual - Black 4m & Pedestrian Modular Rail Black (See Page 84)



Heavy Duty Industrial Swing Gate - Manual - Yellow 3m

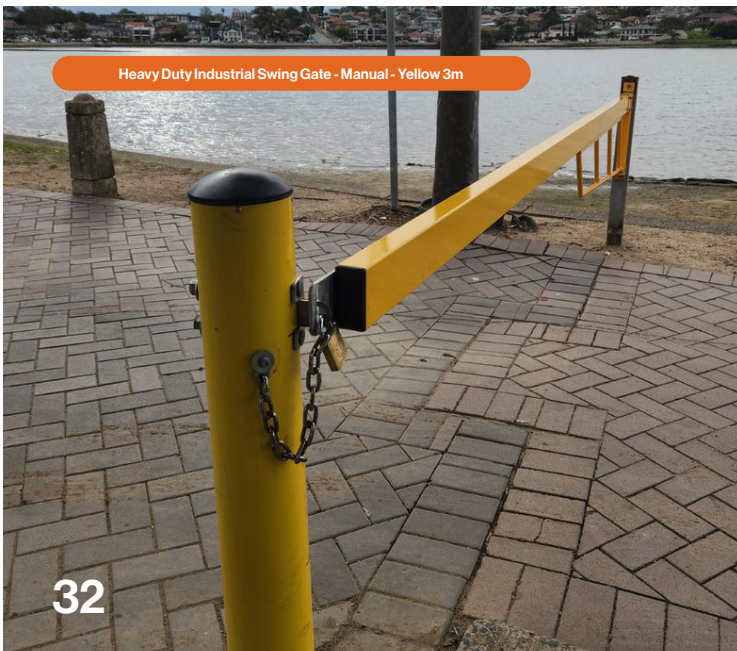

Heavy Duty Industrial Swing Gate - Manual - Yellow 3m



Manual Swing Gates



2m Black



3m Yellow with Standard Message



3m Black with Black & Yellow Reflective Tape

Heavy Duty Industrial Swing Gate Manual

- Aluminium beam, steel supports & hinge
- Heavy duty ball-bearing hinge (180° swing arc)
- Colours: Yellow or Black (custom colours available)
- Wall or post / bollard mounting

code	description	1+
09-SGM2-Y/B	2m Swing Gate	\$1,720.00 / ea
09-SGM3-Y/B	3m Swing Gate	\$1,860.00 / ea
09-SGM4-Y/B	4m Swing Gate	\$2,110.00 / ea
09-SGM-R	Gate Receiver	\$59.90 / ea
09-SGMF	Fastener Kit for bolting swing gate to bollard (2x Gal Bolt & Nut M10 x 170mm with washers)	\$9.90 / kit
08-SF140BP	Fixed Base Plate Bollard (Round base plate) 5mm Wall - Ø140 x 1200(H)mm - 25kg	\$299.00 / ea

Standard Messaging Applied to Gate Arm 1 Side

- (Purchase x2 for both sides)

code	description	1+
09-AVO12	AUTHORISED VEHICLES ONLY	\$129.00 / ea
09-KCT12	KEEP CLEAR AT ALL TIMES	\$129.00 / ea
09-NOE12	NO ENTRY	\$129.00 / ea
09-NOP12	NO PARKING	\$129.00 / ea
09-NPAT12	NO PARKING AT ANY TIME	\$129.00 / ea
09-GT-REFL- (Length)	 Specify Length (2m, 3m, 4m)	\$99.00 / ea

Manual Swing Gate Aluminium

- wall mounting
- Bollard mounting
- 270° swing
- Adjustable
- 3 standard sizes
- Padlock not supplied. Some assembly on site - assembly guide is available.

code	description	1+
09-MSGM2	Aluminium Swing Gate 2400mm	\$699.00 / ea
09-MSGM3	Aluminium Swing Gate 3400mm	\$819.00 / ea
09-MSGM4	Aluminium Swing Gate 4400mm	\$939.00 / ea
09-MSGM-R	Gate Receiver	\$55.00 / ea
08-SF140BP	Fixed Base Plate Bollard (Round base plate) 5mm Wall - Ø140 x 1200(H)mm - 25kg	\$299.00 / ea



Gate Receiver

Extra Heavy Duty Swing Gate - Yellow



Extra Heavy Duty Swing Gate - Black



Extra Heavy Duty Swing Gate - Gal



Extra Heavy Duty Swing Gate - Yellow

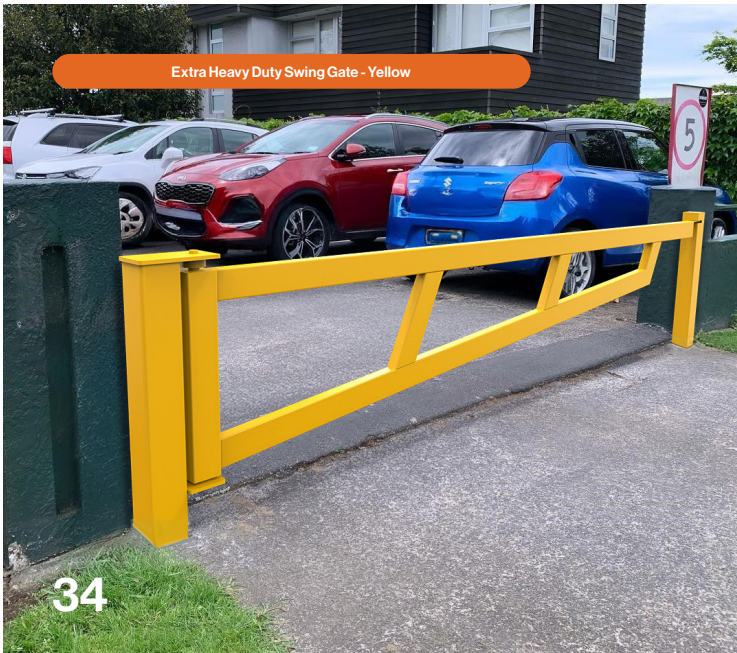

Swing Gate - Extra Heavy Duty - Black



Extra Heavy Duty Swing Gates

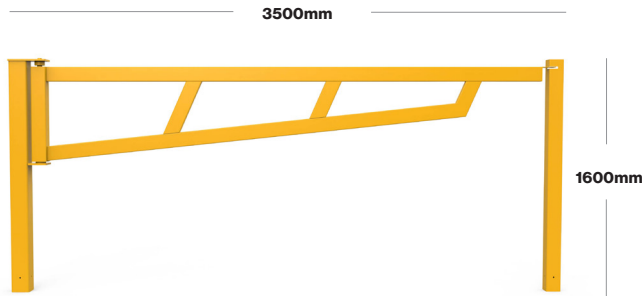

Swing Gate Extra Heavy Duty

- Extremely heavy duty hot dip galvanised swing gate with in-ground post. Ideal for temporary roadways, park access roads, car parks, etc.
- Size: 3500mm (opening length) x 1600mm (overall height) x 135mm (W)
- Recommend 800mm of post concreted below the ground, 800mm above the ground
- Plain Galvanised or Black & Yellow Powder Coat Colours. Custom colours also available.
- Weight: 110kg

code	finish	1+
09-EXHDSG-GAL	Galvanised	\$3,880.00 / ea
09-EXHDSG-BLK	Powder Coated Black	\$4,290.00 / ea
09-EXHDSG-Y	Powder Coated Yellow	\$4,290.00 / ea

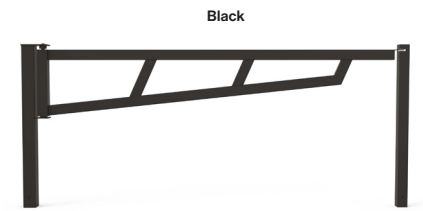
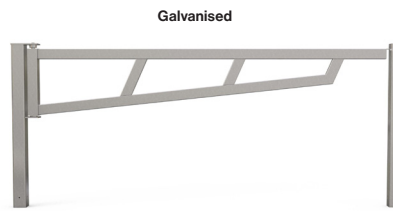
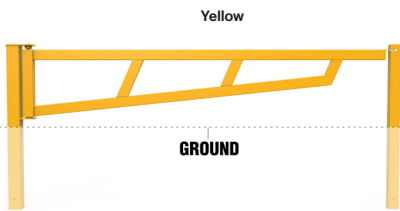

Extra Heavy Duty Swing Gate

1. 5mm Heavy Wall Galvanised Steel
2. Premium Powder Coat — Yellow or Black
3. Heavy Duty Ball Bearing Hinges with grease nipples
4. Hinge Assembly includes height adjustable mechanism
5. 125 x 125mm Heavy Duty Posts
6. Receiver Post includes a cavity to securely lock your gate

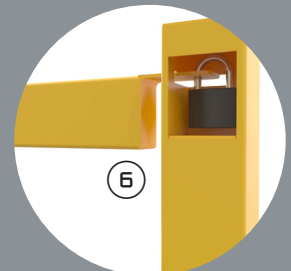
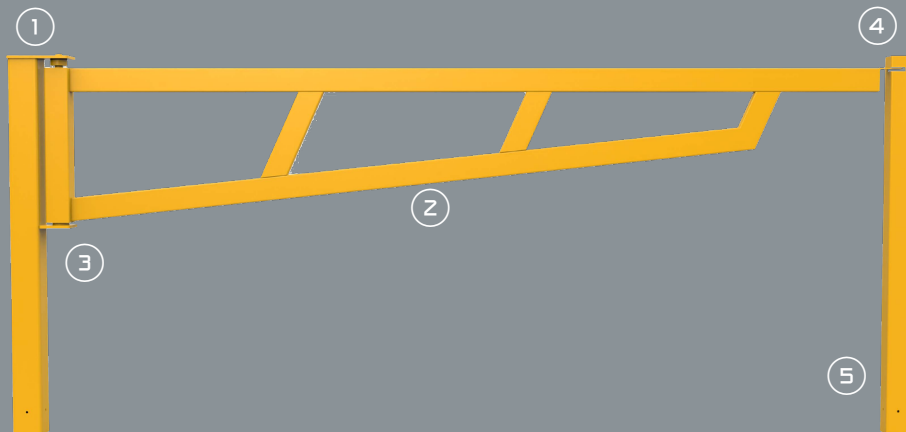

Boom Gate Single Arm



2m Industrial Boom Gate — Black



2m Industrial Boom Gate — Yellow

Heavy Duty Manual Industrial Boom Gate

- Fully Aluminium Construction
- Premium gas strut for smooth raising & lowering
- 3 boom lengths
- Colours: Yellow or Black (custom colours available)
- Lockable receiver post

code	description	opening measurement	1+
09-HDMBG-2	2m Industrial Boom Gate	1720mm	\$2,240.00 / ea
09-HDMBG-3	3m Industrial Boom Gate	2720mm	\$2,499.00 / ea
09-HDMBG-4	4m Industrial Boom Gate	3720mm	\$2,690.00 / ea
08-GSB1275X8	M12x 75mm Galvanised Screw Bolt - Set of 8		\$19.80 / set

Standard Messaging Applied to Gate Boom - 1 Side

- (Purchase x2 for both sides)
- Assisted raising and lowering of the boom arm

code	description	1+
09-AVO12	AUTHORISED VEHICLES ONLY	\$129.00 / ea
09-KCT12	KEEP CLEAR AT ALL TIMES	\$129.00 / ea
09-NOE12	NO ENTRY	\$129.00 / ea
09-NOP12	NO PARKING	\$129.00 / ea
09-NPAT12	NO PARKING AT ANY TIME	\$129.00 / ea
09-GT-REFL- (Length)	 Specify Length (2m, 3m, 4m)	\$99.00 / ea



Boom Gates Double Knuckle Arm

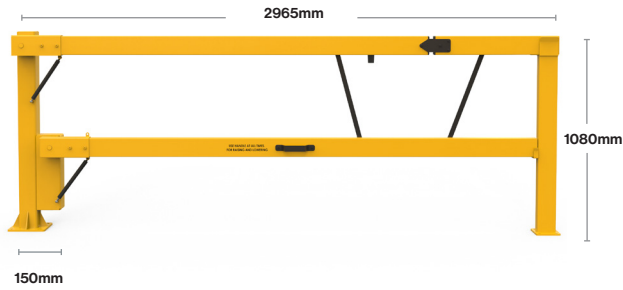

Heavy Duty Knuckle Boom Gate - 2.5m

- Overall Size: 1080(H) x 2886(L) x 150(W)mm
- Opening Width: 2500mm
- Fully Raised Height: 3155mm
- Heavy Duty Aluminium construction
- Powder Coated: Dulux Safety Yellow
- Articulating Boom to reduce raised height
- Premium gas strut for smooth raising & lowering

code	description	1+
09-HDKBG-2.5-L	Heavy Duty Knuckle Boom Gate 2500mm - Left Hand	\$2,790.00 / ea
09-HDKBG-2.5-R	Heavy Duty Knuckle Boom Gate 2500mm - Right Hand	\$2,790.00 / ea
Assembly Required Note: Assisted raising and lowering of the boom arms		

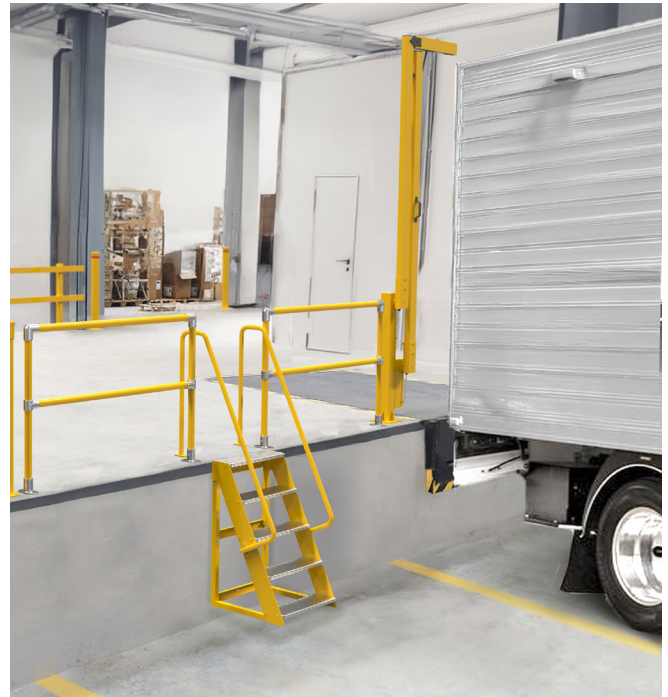
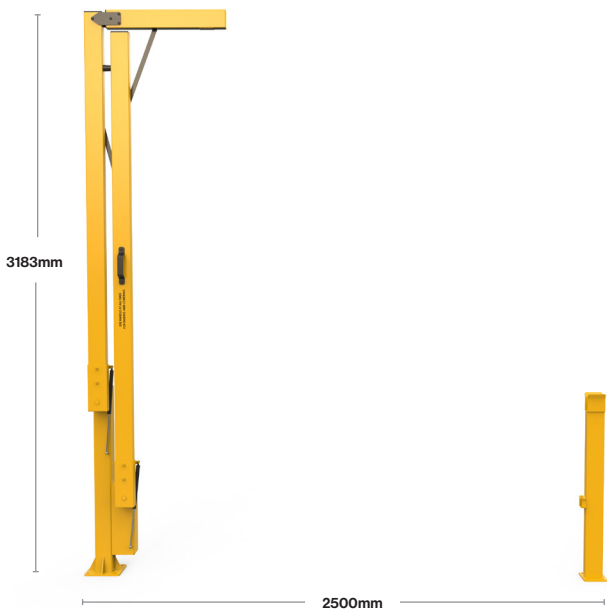

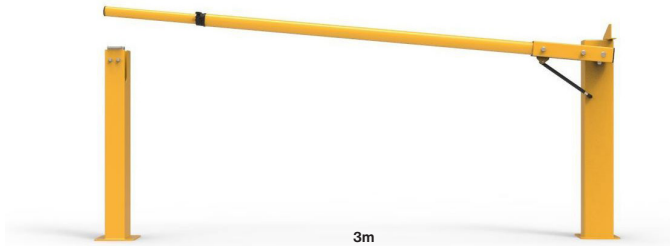

3m



Manual Telescopic Boom Gate

- Max. Opening 3825mm (telescopic)
- Min. Opening 2325mm
- Rail Height 940mm (to centre)
- O/H Clearance 3450mm (for minimum length boom)
- Assisted raising and lowering of the boom arm

code	1+
09-TBG38	\$2,550.00 / ea
08-GSB1275X8	M12 x 75mm Galvanised Screw Bolt - Set of 8 \$19.80 / set

Manual Telescopic Boom Gate Dual Arm

- Max. Opening 3825mm (telescopic)
- Min. Opening 2464mm
- Rail Height 940mm (to centre)
- O/H Clearance 4981mm (for minimum length boom)
- Note: Assisted raising and lowering of the boom arm

code	1+
09-TBG38-DA	\$4,790.00 / ea
08-GSB1275X4	M12 x 75mm Galvanised Screw Bolt - Set of 4 \$9.90 / set

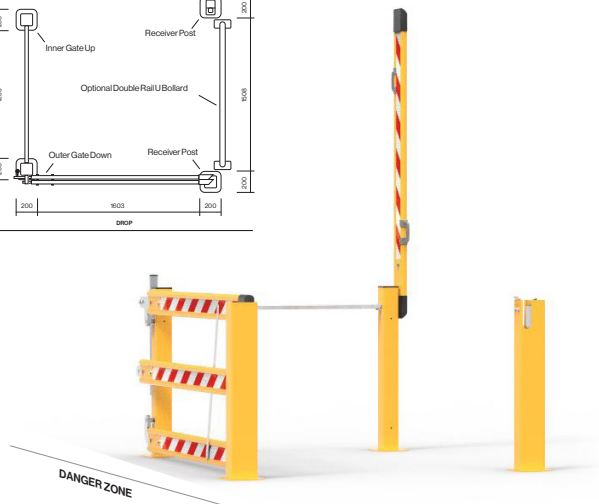
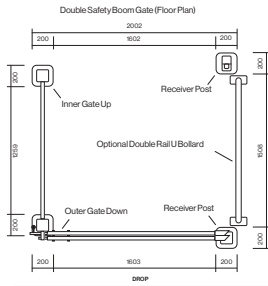

Double Safety Boom Gate

- Creates air-lock safety zone
- Protects workers from exposed edges
- Optional double rail U-bollards can be installed as side infills if required.
- Assisted raising and lowering of the boom arm

code	description	1+
09-DBG15	Double Safety Boom Gate	\$5,499.00 / ea
09-DRB15-BP-Y	Double Rails U-Bollard - Yellow	\$379.00 / ea
08-GSB1275X4	M12 x 75mm Galvanised Screw Bolt - Set of 4 (Requires 1 Set of Fixings per base plate)	\$9.80 / set

Loading Dock Stairs



Heavy Duty Loading Dock Stairs

- Heavy Duty Steel Frame
- Aluminium Checker Plate Steps
- Compliant Dimensions: 1937(H) x 962(D) x 776(W)mm
- Heavy Duty Handrail
- Powder-coated Safety Yellow
- Fix the stairs to the side of the loading dock with screw bolts or similar.
Handrail to be fixed to the top of the loading dock and the side of the stairs.

code	1+
12-LD-STAIRS	\$1,950.00 / ea

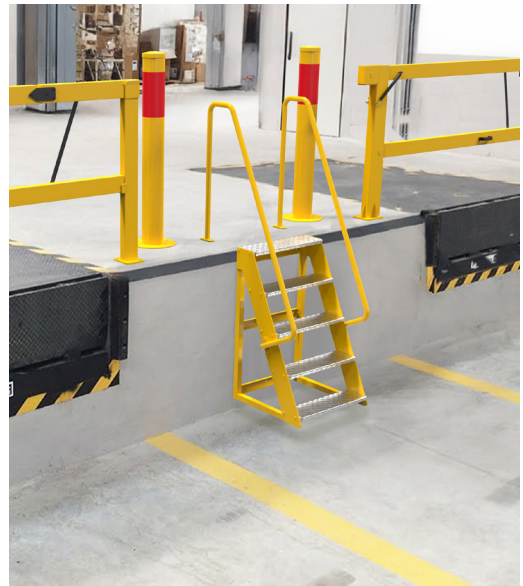

'Tall Rail' Kits

See Page 86-87

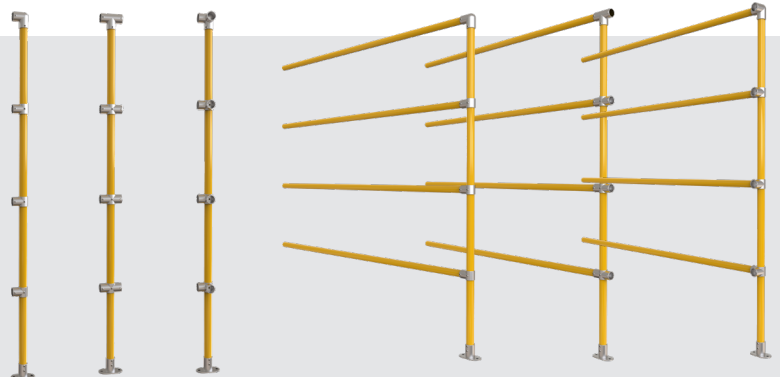

Surex Machine Guarding 1200mm High - Yellow Posts - Yellow Panels



Surex Machine Guarding 1200mm High - Yellow Posts - Black Panels



Surex Machine Guarding 2000mm High - Yellow Posts - Black Panels & Hinged Gate



Surex Machine Guarding 2000mm High - Yellow Posts - Black Panels & Recessed Rail Low Rail



Surex Machine Guarding 2000mm High - Yellow Posts - Black Panels



Surex Machine Guarding

Surex Machine Guarding

- Manufactured from 25 x 25 x 1.6mm thick SHS tube
- Quick and easy installation
- Flexible system mainly applicable to warehouses and factories
- Available in safety yellow or black

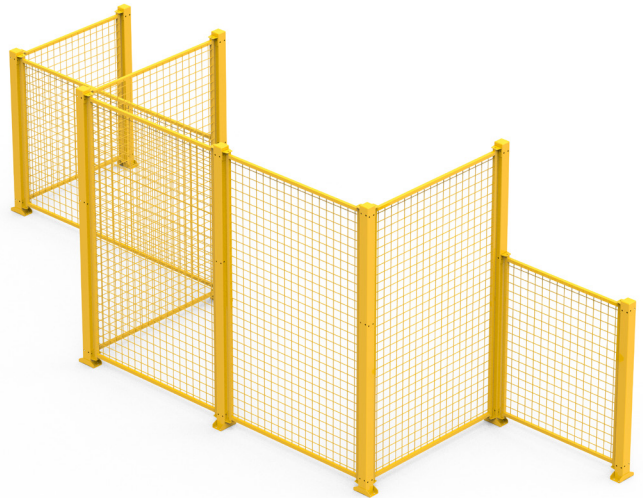

2000mm high screens and posts

code	description	1+
12-SMS20-POST-Y	Tall post yellow: 75 x 75 x 2140(H)mm	\$299.00 / ea
12-SMS20-PANEL-Y	Yellow screen with 4 brackets: 2040(H) x 1220(W)mm	\$279.00 / ea
12-SMS20-PANEL-B	Black screen with 4 brackets: 2040(H) x 1220(W)mm	\$279.00 / ea

1200mm high screens and posts

code	description	1+
12-SMS12-POST-Y	Post yellow: 75 x 75 x 1340(H)mm	\$199.00 / ea
12-SMS12-P1000-Y	Yellow screen with 4 brackets: 1240(H) x 1020(W)mm	\$179.00 / ea
12-SMS12-P1000-B	Black screen with 4 brackets: 1240(H) x 1020(W)mm	\$179.00 / ea
12-SMS12-P2400-Y	Yellow screen with 4 brackets: 1240(H) x 2020(L)mm	\$279.00 / ea
12-SMS12-P2400-B	Black screen with 4 brackets: 1240(H) x 2020(L)mm	\$279.00 / ea

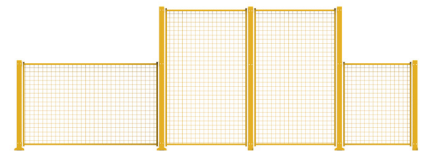

Example configuration using all sizes of screens and posts.

Modular Machine Guarding example

Screens available in three sizes and two colours — yellow and black

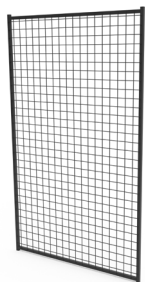

2000mm (H) x 1200mm (W) screens

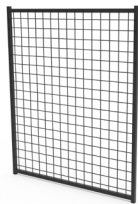

1200mm (H) x 1000mm (W) screens

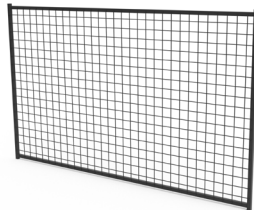

1200mm (H) x 2000mm (W) screens

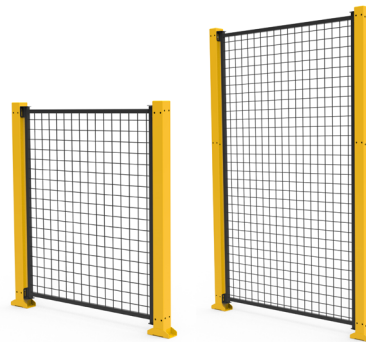

2.14m posts

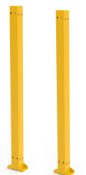

1.34m posts

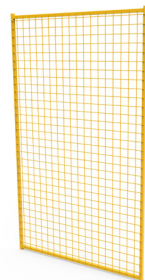

2000mm (H) x 1200mm (W) screens

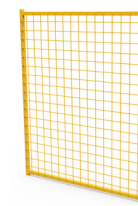

1200mm (H) x 1000mm (W) screens

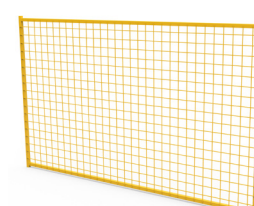

1200mm (H) x 2000mm (W) screens

Machine Guarding Gates

See Page 119

Surex Machine Guarding



NEW

Surex Machine Guarding Solid Panel

- Manufactured from 25 x 25 x 1.6mm thick SHS tube
- Quick and easy installation
- Solid panel for visual block and safety
- Available in safety yellow or black

code	description	1+
12-SMS20-POST-Y	Tall post yellow: 75x75x2140(H)mm	\$299.00 / ea
12-SMS20-SOLID-Y	Yellow Solid Screen with 4 brackets: 2054(H) x 1220(W)mm	\$689.00 / ea
12-SMS20-SOLID-B	Black Solid Screen with 4 brackets: 2054(H) x 1220(W)mm	\$689.00 / ea

3 panel configuration

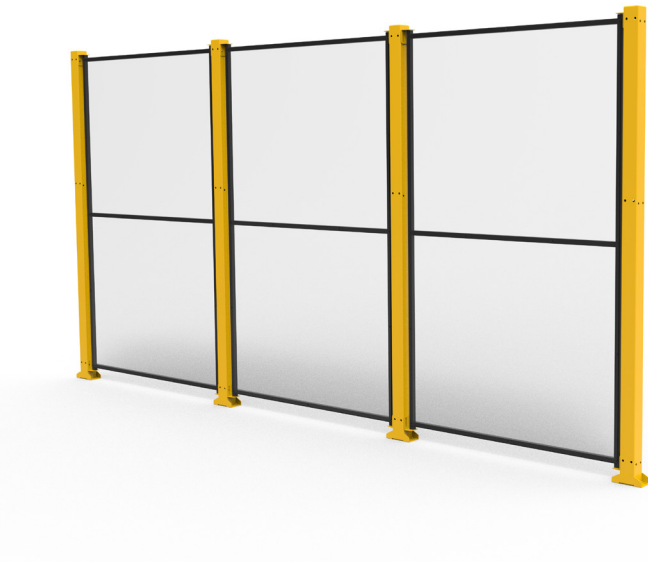
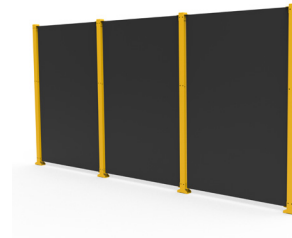

NEW

Surex Machine Guarding Polycarbonate Panel

- Manufactured from 25 x 25 x 1.6mm thick SHS tube
- Quick and easy installation
- 3mm Polycarbonate Panel ensures safety without obstructing view of operations

code	description	1+
12-SMS20-POST-Y	Tall post yellow: 75x75x2140(H)mm	\$299.00 / ea
12-SMS20-POLY	Polycarbonate Panel with 4 brackets & fixings: 2040(H) x 1220(W)mm	\$599.00 / ea

Surex Machine Guarding Gate



Surex Machine Guarding Gate Hinged

- Manufactured from 25 x 25 x 1.6mm thick SHS tube
- Available in safety yellow or black
- Quick and easy installation
- Heavy Duty 2-Way Locking System
- Flexible system — can be installed on angles up to 90°

code	description	1+
12-SMS12-GATE-B	Black with heavy duty hinges and lockable latch 1240(H) x 1020(W)	\$429.00 / ea
12-SMS12-GATE-Y	Yellow with heavy duty hinges and lockable latch 1240(H) x 1020(W)	\$429.00 / ea
12-SMS20-GATE-B	Black with heavy duty hinges and lockable latch 2040(H) x 1220(W)	\$639.00 / ea
12-SMS20-GATE-Y	Yellow with heavy duty hinges and lockable latch 2040(H) x 1220(W)	\$639.00 / ea

2140mm high screens and posts with gate section

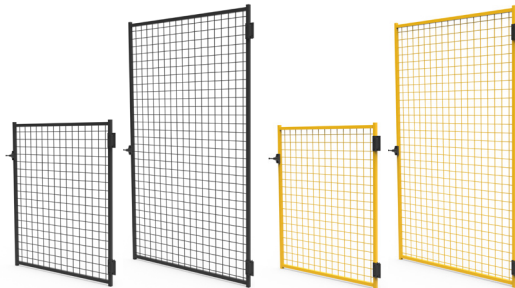
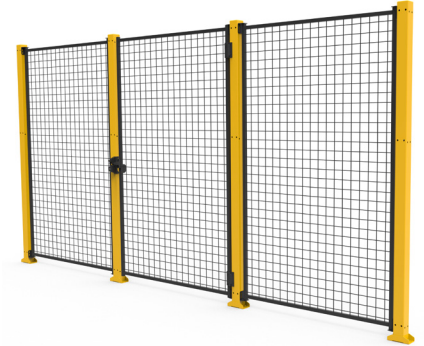

1200mm high screens with posts and gate section



NEW

Surex Machine Guarding Gate Sliding

- Manufactured from 25x25x1.6mm thick SHS tube
- Heavy Duty Sliding Gate Runners
- No overhead height restrictions
- Available in safety yellow or black
- Size: 2040(H) x 1220(W)mm
- Note: Sliding Gate shown with standard machine guarding panel either side.

code	description	1+
12-SMS20-SLGT-B	Black with heavy duty hinges and lockable latch 1240(H) x 1020(W)	\$1,990.00 / ea
12-SMS20-SLGT-Y	Yellow with heavy duty hinges and lockable latch 1240(H) x 1020(W)	\$1,990.00 / ea

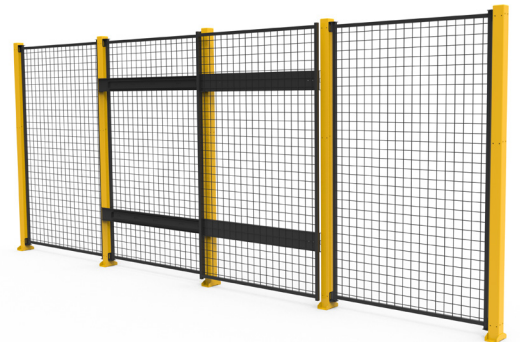



How to ensure a safe pallet racking system in industrial environments

In industrial settings, pallet racking systems play a critical role in efficient storage and organisation. However, maintaining the safety of these structures is equally essential to prevent accidents, protect inventory, and ensure a safe workplace. In this article, we'll outline key practices and considerations for creating and maintaining a safe pallet racking system in industrial environments.

Start with quality materials and professional installation

The foundation of a safe racking system lies in the materials used and how it's installed. Choosing high-quality steel racking that meets Australian Standards (AS4084) is vital. This ensures your racking system can handle industrial demands and supports long-term stability. Professional installation by certified experts is also crucial, as it guarantees correct placement and structural integrity, reducing risks from the outset.

Regular inspections and proactive maintenance

Frequent inspections play a critical role in catching issues early. Regular checks can help spot any signs of damage, such as loose bolts, bends, or cracks. If any issues are detected, it's essential to carry out repairs immediately to prevent further damage or failure. Consistent maintenance, including checking for corrosion and worn parts, will keep the racking in top condition and extend its lifespan.

Load compliance and safe forklift operation

Marking load capacities on racks and educating staff on these limits helps prevent overloading, which is a common cause of racking collapses. Additionally, staff should practise balanced loading, ensuring weight is evenly distributed to avoid excessive stress on beams. Forklift operators should receive specialised training to load and unload racking safely and to drive cautiously near racking systems to avoid accidental collisions.

Safety accessories for added protection

Adding accessories like pallet racking guards and end-of-aisle barriers can enhance safety significantly, protecting racks from accidental bumps or collisions. Anti-collapse mesh is also valuable, especially in high-traffic areas, as it secures pallets and prevents items from falling into adjacent aisles or storage zones.

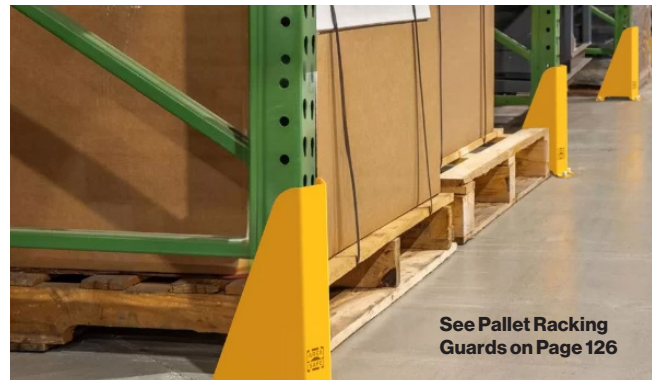

See Pallet Racking Guards on Page 126

Staff training and compliance monitoring

A safe racking system depends on an informed team. Routine training on racking safety protocols, such as proper pallet stacking and emergency procedures, ensures employees can handle the system safely. Regular compliance checks also keep your system aligned with safety regulations, helping you stay up-to-date on industry standards and reduce liability risks.

Australian Standards for safe pallet racking systems

To ensure full compliance and safety, adhere to the following Australian Standards relevant to pallet racking:

- ◆ AS 4084.1:2023 – Steel Storage Racking – Design
- ◆ AS 4084.2:2023 – Steel Storage Racking – Operation and Maintenance
- ◆ AS4068:1993 – Flat Pallets for Materials Handling
- ◆ AS4762:2000 – General Purpose Flat Pallets, Principal Dimensions and Tolerances.

Achieving safe, reliable pallet racking

By following these best practices and aligning with Australian Standards, you'll build a secure, compliant pallet racking system that protects your workforce and enhances operational efficiency.

For advice on additional protective solutions or further guidance, **contact Area Safe on 1300 613 880** to help tailor a solution to your needs.



The importance of Machine Guarding

In today's industrial landscape, worker safety is paramount. As machinery becomes more advanced and powerful, effective safety measures become increasingly critical. One of the most crucial safety measures is machine guarding. This blog explores the importance of machine guarding and its benefits, with a special focus on high-quality solutions offered by Area Safe.

Understanding Machine Guarding

Machine guarding involves using protective barriers and devices to shield workers from machinery hazards. These hazards include moving parts, flying debris, electrical issues, mechanical malfunctions, pinch points and crush zones. Additionally, machine guarding prevents unauthorised access to restricted areas, ensuring only trained personnel can operate or maintain machinery. The primary goal is preventing accidents and injuries, ensuring a safe working environment.



See Machine Guarding on
Pages 116-119

The benefits of proper Machine Guarding

Proper machine guarding offers numerous advantages that enhance workplace safety and operational efficiency. Key benefits include:

- ◆ **Injury prevention**
Machine guarding reduces injury risks like cuts, burns, and fractures by preventing contact with dangerous parts and shielding against flying debris.
- ◆ **Regulatory compliance and enhanced reputation**
Adhering to safety standards avoids legal penalties and enhances company reputation, demonstrating commitment to employee well-being.
- ◆ **Increased productivity and equipment protection**
Safe workers operate more efficiently, reducing accident-related downtime. Guards protect machinery from damage, extending equipment lifespan.
- ◆ **Improved morale and operational efficiency**
A safe workplace boosts morale and job satisfaction. Workers perform better and ensure consistent product quality.
- ◆ **Risk Management**
Machine guarding helps identify and mitigate potential hazards before incidents occur.

Area Safe's Surex Machine Guarding solutions

Our Surex Machine Guarding range offers high-quality solutions designed to protect your workforce and comply with industry standards. Products include 1.2m and 2m high mesh panels with optional guarding gates, heavy duty hinges and lockable latches.

Investing in proper machine guarding is essential for any industrial operation. It protects workers, ensures regulatory compliance, and enhances productivity and efficiency. With the right guarding solutions, such as Area Safe's Surex Machine Guarding range, you can create a safer, more productive workplace.

For more information on our products and how they benefit your operations, visit **Area Safe's Surex Machine Guarding** page.

Downpipe Guards



Galvanised Steel Downpipe Protectors

- Industrial 2mm thickness (3mm available - please enquire)
- Galvanised
- Side flanges 50mm wide
- Pre-drilled Ø14 fixing holes

code	description	1+
21-GDP150	150(W) x 150(D) x 1200(H) x 2mm	\$179.00 / ea
21-GDP200	200(W) x 200(D) x 1200(H) x 2mm	\$199.00 / ea
21-GDP250	250(W) x 250(D) x 1200(H) x 2mm	\$225.00 / ea



Yellow Downpipe Protectors

- Industrial 2mm thickness (3mm available - please enquire)
- powder coat Safety Yellow
- Side flanges 50mm wide
- Pre-drilled Ø14 fixing holes

code	description	1+
21-GDP150-Y	150(W) x 150(D) x 1200(H) x 2mm	\$288.00 / ea
21-GDP200-Y	200(W) x 200(D) x 1200(H) x 2mm	\$319.00 / ea
21-GDP250-Y	250(W) x 250(D) x 1200(H) x 2mm	\$359.00 / ea



Heavy Duty Column Guards

NEW

Heavy Duty Column Guards

- Heavy 5mm Wall 90x90mm Posts
- 100x50mm Heavy Duty Steel Rail
- Height: 985mm
- 4 Different Size Options
- Powder Coated Safety Yellow

code	description	1+
12-HD4SCG888	4-Sided Square 800x800mm	\$1,560.00/ ea
12-HD2SCG888	2-Sided Column Guard 800x800mm	\$1,150.00/ ea
12-HD4SCG168	4-Sided Rectangular 1600x800mm	\$1,980.00/ ea
12-HD3SCG168	3-Sided Rectangular 1600x800mm	\$1,640.00/ ea

4-Sided Square



2-Sided Column Guard



4-Sided Rectangular



3-Sided Rectangular



Surex Low Recessed Rail



Surex Low Recessed Rail



Surex Heavy Duty Floor Angle (Page 126)



Loading Dock Reversing Guides (Page 126)

Base Plate Bollards (Page 25)



Surex 'Recessed Rail' Warehouse Barriers



Surex Low Recessed Rail Features

1. Premium safety yellow powder coat
2. Heavy wall steel post & rail
3. Recessed rail attachment for extra strength
4. 4 sizes options
5. Non-trip base plates
6. Full galvanised - no rust!

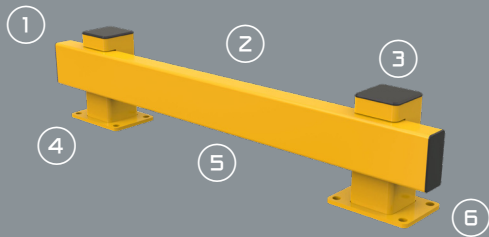

Surex Low Recessed Rail Barriers

- Heavy wall galvanised steel posts and rails
- Powder coated safety yellow
- Size: 124.5mm (W) x 211.5mm (H)
- Custom colours and lengths available, please enquire
- Lengths: 1m, 2m, 3m and 4m

code	description	1+
12-SRLR1	1m - Low Recessed Rail	\$585.00 / set
12-SRLR2	2m - Low Recessed Rail	\$699.00 / set
12-SRLR3	3m - Low Recessed Rail	\$825.00 / set
12-SRLR4	4m - Low Recessed Rail	\$995.00 / set
08-GSB1275X4	M12 x 75mm Galvanised Screw Bolt - Set of 4 (Require 1 set of fixings per base plate)	\$9.90 / set



1m Low Recessed Rail

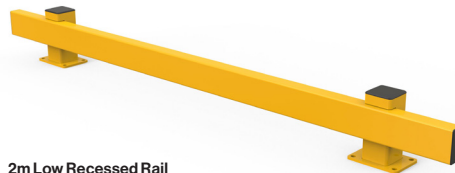

2m Low Recessed Rail



3m Low Recessed Rail

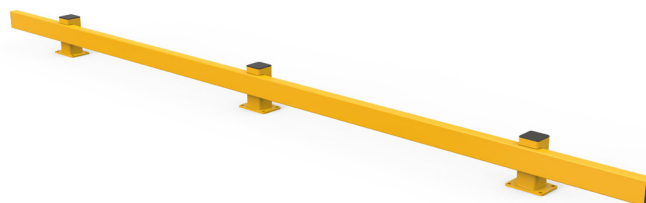

4m Low Recessed Rail

Recessed Rail Pedestrian Gates - Alarmed

See Pages 97



Steel Truck Loading Dock Reversing Guides

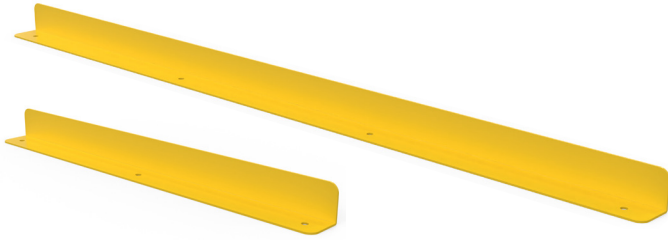

Surex Heavy Duty Floor Angle



- Very heavy duty floor stop, ideal for stopping pallets hitting and damaging walls or barriers

code	description	1+	10+
12-HDFA12	100x100x5(T) x 1200(L)mm	\$249.00 / ea	\$219.00 / ea
12-HDFA24	100x100x5(T) x 2400(L)mm	\$329.00 / ea	\$299.00 / ea
08-GSB1275X4	M12 x 75mm Galvanised Screw Bolt - Set of 4	\$9.90 / set	

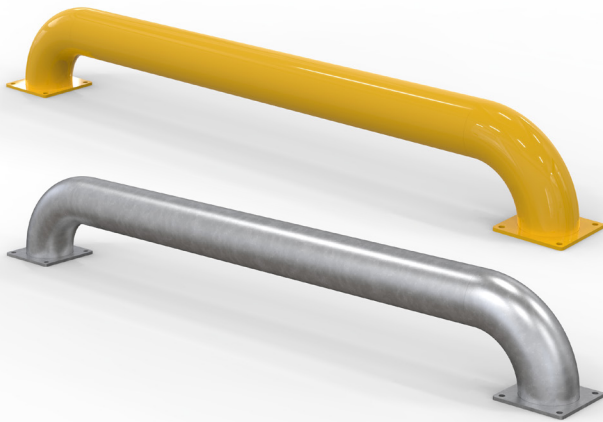

Galvanised Steel Truck Loading Dock Reversing Guides

- Size: 2303(L) x 220(W) x 311(H)mm (Diameter 165mm)
- Finish: Yellow & Galvanised

code	description	1+
07-STWSC-Y	Yellow	\$1595.00 / ea
07-STWSC-G	Galvanised	\$1495.00 / ea
08-GBM16110	Galvanised M16x110mm Sleeve Anchor with Washer (8 required per reversing guide)	\$4.20
08-GSB16100X4	M16 x 100mm Galvanised Screw Bolt - Set of 4 (Requires 2 sets per base plate)	\$23.90 / set



Pallet Racking Guards

- Safety Yellow
- Complies to AS4084-2023
- Suit 90-100mm Pallet Racking Uprights



Plastic

Steel

Installation Tool

code	description	1+
12-PRG400-S	Pallet Racking Guard - Steel 400mm 223.5 (W) x 400 (H)mm	\$139.00 / ea
12-PRG600-P	Pallet Racking Guard - Plastic 600mm 144 (W) x 600 (H)mm	\$159.00 / ea
12-PPRG-TOOL	Plastic Pallet Racking Guard Installation Tool Makes installing the plastic pallet racking guard very simple.	\$649.00 / ea-



Stainless Steel Corner Guard (No Holes)

- Size: 40 x 40 x 1200(L)mm
- Thickness: 1.6mm

code	1-9	10-24	25+
21-SSCG40	\$89.00/ea	\$79.00/ea	\$65.00/ea



Galvanised Steel Corner Guard

50mm Profile (no holes)

- Size: 50 x 50 x 1200(L)mm
- Thickness: 2mm

100mm Profile (with holes)

- Size: 100 x 100 x 1200(L)mm
- Thickness: 3mm

code	description	1-9	10+
21-GCG-50	50mm	\$65.90/ea	\$59.90/ea
21-GCG	100mm	\$119.00/ea	\$108.00/ea



Rubber Corner Guard

- Size: 100 x 100 angle x 800(L)mm
- Colour: Black/Yellow Hi-Vis or Plain Black

code	description	1-9	10+
21-RCP-BY	Black/Yellow	\$32.00/ea	\$26.50/ea
21-RCP-B	Plain Black	\$32.00/ea	\$26.50/ea



PVC Corner Guard

- Size: 50 x 50 x 1200(L)mm
- Thickness: 2.5mm
- Colour: White

code	1-19	20+
21-PVC5012	\$74.90/ea	\$62.90/ea

* Small order charge \$25.00+GST for less than 10.

Black/Yellow Rubber Corner Guards (See Page 127)



Extruded Rubber Dock Fender

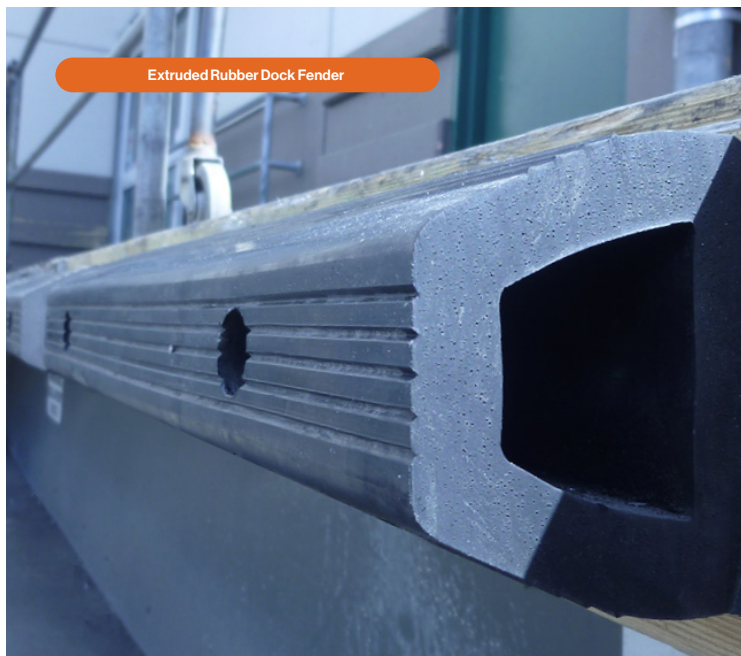

Black/Yellow Rubber Corner Guards (See Page 127)



D-Type Moulded Rubber Dock Bumper



Rubber Wall Protector

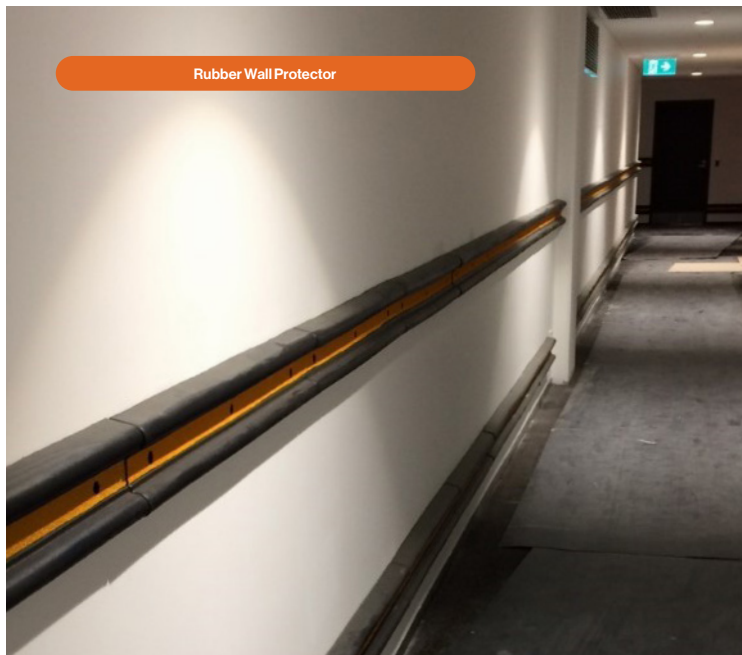

Extruded Rubber Dock Fender

- Size: 92(D) x 105(H) x 2400(L)mm
- Thickness: 19.5mm

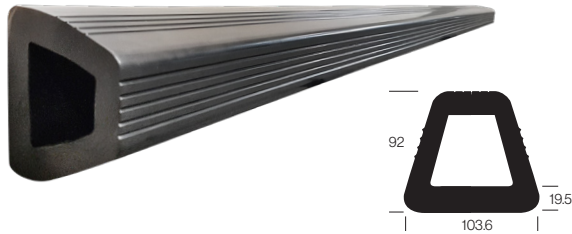

code	1+
21-RDF	\$419.00 / ea

D Type Moulded Rubber Dock Bumper

- Size: 100(D) x 100(H) x 900(L)mm
- Thickness: 25mm
- Non-flexible



code	1-9	10+
21-RDDB	\$69.90 / ea	\$57.80 / ea

Extruded Rubber Wall Guard

- Size: 40(D) x 50(H) x 3000(L)mm
- Thickness: 8mm

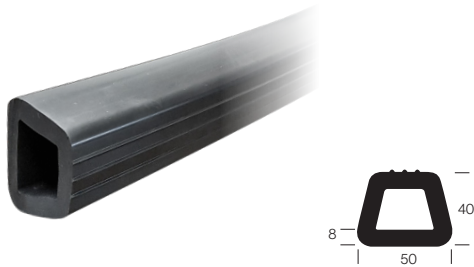

code	1+
21-RWG	\$199.00 / ea

Rubber Dock Bumper

- Size: 100(D) x 330(H) x 250(W)mm

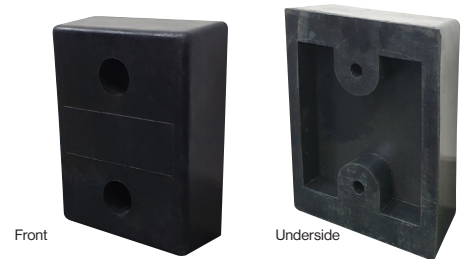

code	1-9	10+
21-RDB	\$145.00 / ea	\$129.00 / ea

Rubber Wall Protector

- Size: 55(D) x 150(H) x 1000(L)mm



code	1-9	10+
21-RWP	\$49.90 / ea	\$42.50 / ea

Heavy Duty Wall & Column Protector

- Size: 40(D) x 115(H) x 5000(L)mm



code	1-4	5+
28-RBS115	\$449.00 / roll	\$399.00 / roll

Rubber Protectors



Rubber Column Guard

■ Size: 30(D) x 200(H) x 5000(L)mm

code	1-5	6+
21-RCG	\$145.00/roll	\$125.00/roll



Column Cushion

- Foam filled LDPE
- 2 halves with velcro straps
- Suits 5 different column diameters

code	description	1+
21-CC350-100	350mm outer, 100mm inner, 900mm high	\$825.00/ ea
21-CC350-150	350mm outer, 150mm inner, 900mm high	\$825.00/ ea
21-CC610-200	610mm outer, 200mm inner, 900mm high	\$1,288.00/ ea
21-CC610-250	610mm outer, 250mm inner, 900mm high	\$1,288.00/ ea
21-CC610-300	610mm outer, 300mm inner, 900mm high	\$1,288.00/ ea

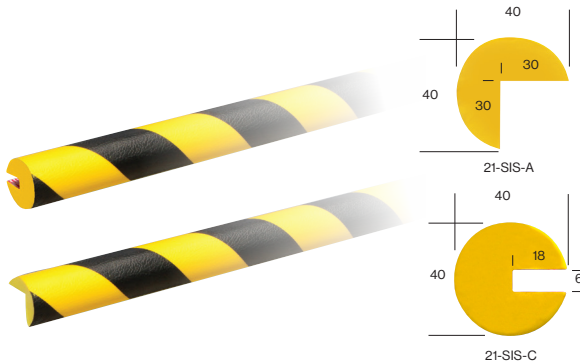

Safety Impact Strips

- Closed cell polyurethane foam
- Self adhesive backing
- 1000mm long

code	description	1-9	10+
21-SIS-A	Angle Profile	\$46.90/ ea	\$42.90/ ea
21-SIS-C	'C' Profile	\$46.90/ ea	\$42.90/ ea



Manifest Cabinet

■ Size: 460(W) x 350(H) x 100(D)mm

code	1+
26-25001	\$229.00 / ea



Document Storage Box Medium

- Top opening
- Heavy duty polyethylene - Made in USA
- Weather proof and lockable (padlock by others)
- Size: 318(H) x 260(W) x 57(D)mm
- Includes standard and blank labels

code	1+
26-23303	\$229.00 / ea



Document Storage Box Large

- Front opening
- Heavy duty polyethylene - Made in USA
- Weather proof and lockable (padlock by others)
- Size: 400(H) x 340(W) x 90(D)mm
- Includes standard and blank labels

code	1+
26-23306	\$295.00 / ea

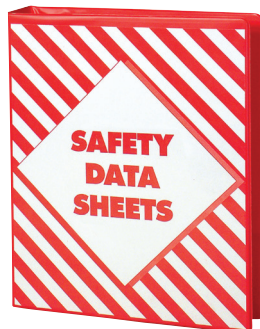

S.D.S. Folder

■ Bright coloured folder to store A4 Safety Data Sheets.

code	1+
26-MDSDF	\$44.50 / ea

Other Area Safe Categories



Carpark Protection

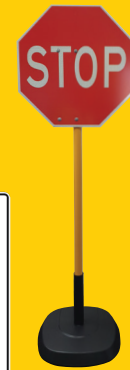

Signage & Safety

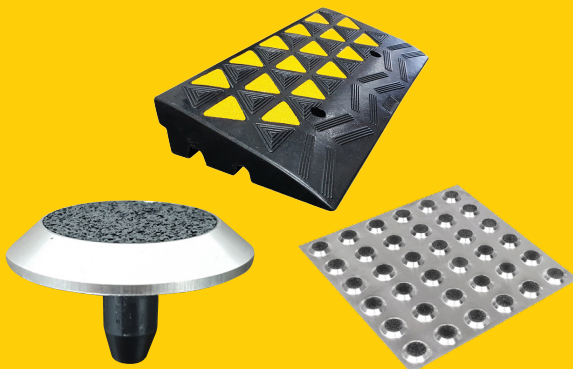

Matting Ramps & Tactiles

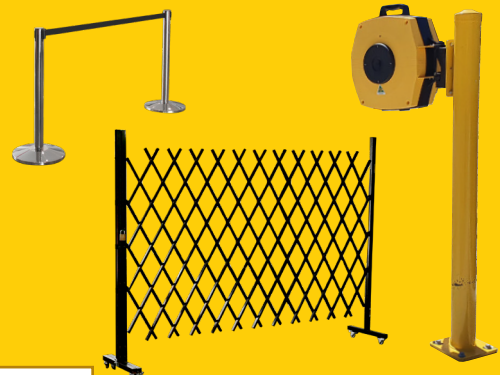

Pedestrian Barriers



www.areasafe.com.au



Email: sales@areasafe.com.au

Mail: PO Box 82, Plumpton NSW 2761

Address: 17 Sterling Road, Minchinbury NSW 2770

Hours: Open from 7:00am - 5:00pm, Monday to Friday