

Area Safe Products Car Park CATALOGUE

40



→ Customer Focused

→ Speedy Service

→ Innovative Products



2025
Edition

phone 1300 613 880

Web www.areasafe.com.au
Email sales@areasafe.com.au



Why Choose Area Safe Products?

Customer Focused



Speedy Service



Innovative Products

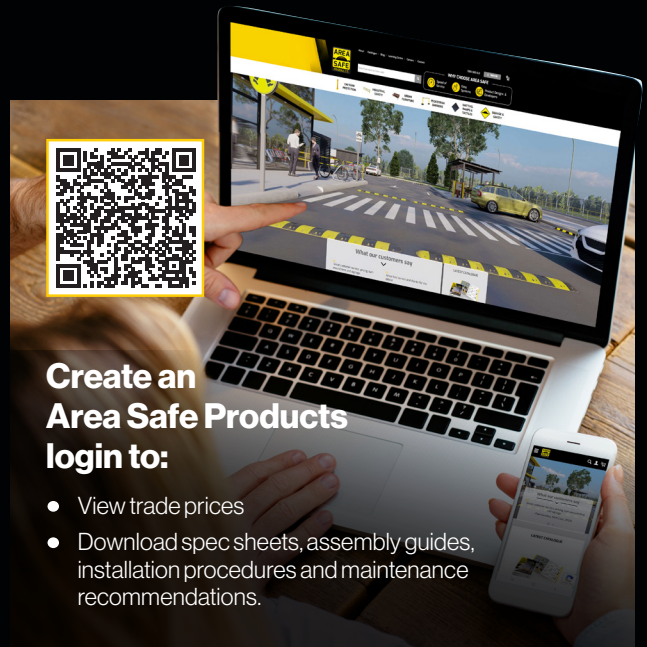

Create an Area Safe Products login to:

- View trade prices
- Download spec sheets, assembly guides, installation procedures and maintenance recommendations.

Contact us

Email: sales@areasafe.com.au
Web: www.areasafe.com.au
Mail: PO Box 82, Plumpton NSW 2761

Address: Sydney: 17 Sterling Road, Minchinbury, NSW 2770 (Head Office, Warehouse & Production)

Melbourne: Suite 208/15 Cochranes Road, Moorabbin VIC 3189 (Office only)

Brisbane: Level 11, Suite 5, 88 Tribune Street, South Brisbane QLD 4101 (Office only)

Open: 7:00am - 5:00pm, Monday-Friday

ABN: 74 114 414 185

Phone: 1300 613 880

All prices advertised through this catalogue exclude 10% GST. Design & prices subject to change without notice. E&OE © 2024 Area Safe Products Pty Ltd.



Contents

Car park products

AREA SAFE PRODUCTS

OCTOBER 2025

SPECIALITY CATALOGUE #40

Car Wheel Stops	4	Concrete Sphere Bollards	40
Truck and Large Vehicle Wheel Stops	7	Concrete Logs	43
Speed Humps	9	Flexible Traffic Separator	47
Premium Steel Speed Humps	14	Lane Dividers	48
Premium Bollards	19	Line Marking	49
Bollards Base plate	20	Safety Stencil	50
Bollards In-ground	21	Trolley Bay	52
Bollards Accessible Shared Zone	23	Convex Safety Mirrors	56
Removable Bollards Key and Padlocked	27	Safety Dome Mirrors	57
Parking Space Protectors	30	Height Restriction Bar	58
The Berlin Bollard Suite	35	Bike Rails & Scooter Racks	60

4-6



7-8



9-13

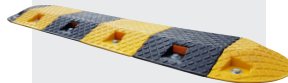

14-17



18-19



20



21



23



27



30



35



40

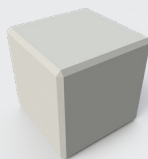

43

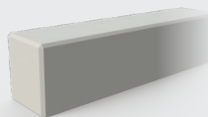

47



48-49



50-51



52-55

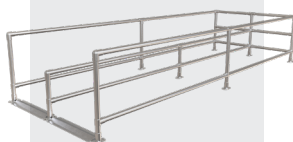

56-57



58-59



60-71



Rubber Wheel Stop Features

1. High density long lasting rubber (does not break up like alternatives)
2. Fixing holes sizing suitable for concrete or bitumen slabs
3. 100% Australian Standards size compliant
4. UV protected rubber and reflective
5. Hi-Vis reflective strip with high-bond adhesive
6. Heavy weight 14kg

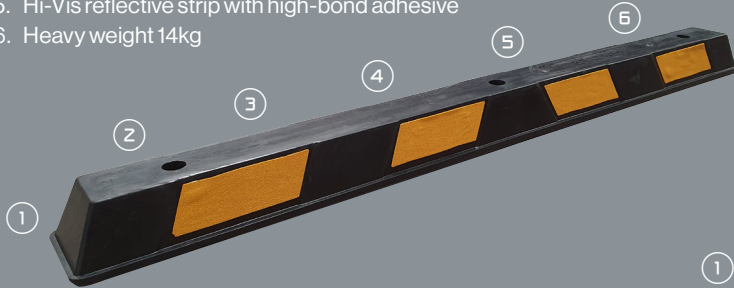

Concrete Wheel Stop Features

1. Lower height to suit all vehicles
2. 100% Australian Standards compliant
3. Flat front to stop vehicle mounting
4. Larger fixing points
5. Reinforced concrete
6. Extra wide base for stability
7. Bevelled edges to stop tipping



Black / Yellow Rubber Wheel Stop



Black / Yellow Rubber Wheel Stop



1.65m Concrete Wheel Stop



1.65m Concrete Wheel Stop





Premium Rubber Wheel Stops

- Size: 1650(L) x 100(H) x 140(W)mm
- Weight: 14kg

✓ Complies with AS2890.1-2004



code	description	1-9	10-49	50-99	100+
07-WSRT	Rubber wheel stop black/yellow	\$82.90 / ea	\$67.90 / ea	\$59.90 / ea	\$54.90 / ea
07-WSRFC	Fasteners - into concrete M12 x 150mm Gal Screw Bolt (x3)	\$12.00 / set			
07-WSRFB	Fasteners - into bitumen M12 x 300mm gal with head (x3)	\$12.00 / set			



1.65m Precast Concrete Wheel Stops For Cars

- Size: 1650(L) x 90(H) x 190(W)mm
- Weight: 55Kg

✓ Complies with AS2890.1-2004

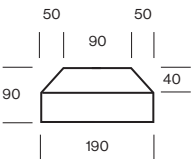

code	description	1-9	10-49	50+
07-WSC	Concrete wheel stop for cars	\$94.90 / ea	\$89.90 / ea	\$79.90 / ea
07-WSCF-C	Fasteners - into concrete M12 x 150 dowel (x2)	\$8.00 / set		
07-WSCF-B	Fasteners - into bitumen M12 x 300 gal with head (x2)	\$8.00 / set		

NEW

Wheel Stop / Kerb Signs

- Size: 60mm (H) x 600mm (W)
- Material: Metal
- Note: Pricing is only for signs



code	price
07-RPWSS	RESERVED PARKING \$59.90 / ea
07-SPWWS	STAFF PARKING \$59.90 / ea
07-CPOWSS	CUSTOMER PARKING ONLY \$59.90 / ea
07-CUSWWS	CUSTOM MESSAGE \$72.90 / ea

2.4m Precast Concrete Wheel Stop Features

1. Australian Made
2. Perfect for small trucks, large vans and buses
3. Heavy duty fixings for concrete or bitumen slabs available
4. Bevelled edges to lessen the risk of tripping hazards
5. High strength concrete construction
6. Fixing holes positioned for maximum impact strength
7. Strengthened through heavy duty reinforcing bars



2.4m Concrete Truck Wheel Stop



2m Concrete Wheel Stop



Video - Concrete Wheel Stop Overview

Solutions for Safe Vehicle
& Pedestrian Movement





1m Precast Concrete Wheel Stops For Trucks & Equipment

- Size: 1000(L) x 190(W) x 145(H)mm
- Weight: 55Kg

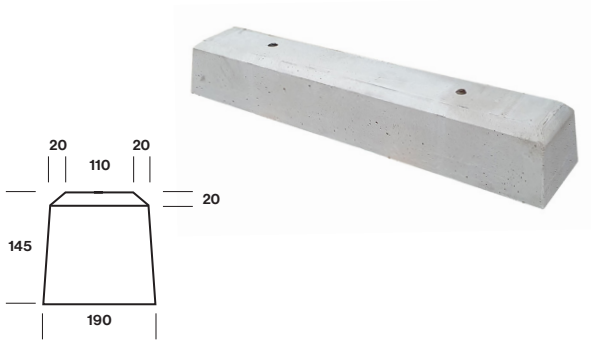

code	description	1-9	10+
07-WSC-1	1m concrete wheel stops (2 Required per vehicle)	\$135.00 / ea	\$115.00 / ea
07-WSCF-C	Fasteners - into concrete M12 x 150 dowel (x2)	\$8.00 / set	
07-WSCF-B	Fasteners - into bitumen M12 x 300 gal with head (x2)	\$8.00 / set	

2m Precast Concrete Wheel Stops For Minibuses & Trucks

- Size: 2000(L) x 190(W) x 145(H)mm
- Weight: 110Kg

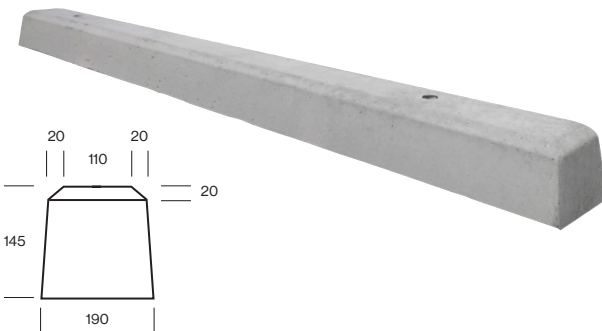

code	description	1-9	10+
07-WSC-2	2m concrete wheel stops	\$245.00 / ea	\$215.00 / ea
07-WSCF-C	Fasteners - into concrete M12 x 150 dowel (x2)	\$8.00 / set	
07-WSCF-B	Fasteners - into bitumen M12 x 300 gal with head (x2)	\$8.00 / set	

2.4m Precast Concrete Wheel Stops For Trucks

- Size: 2400(L) x 260(W) x 205(H)mm
- Weight: 260kg

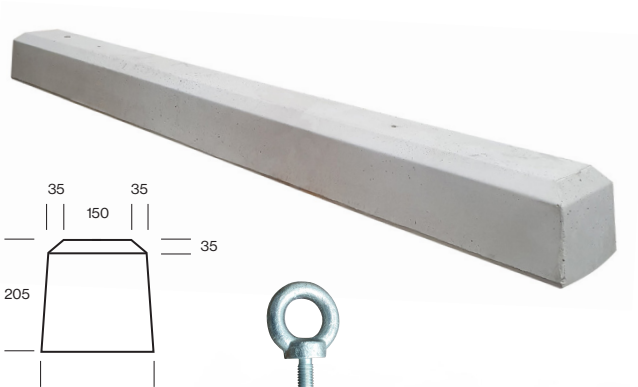

code	description	1-9	10+
07-TWSC	Concrete wheel stop for trucks	\$399.00 / ea	\$375.00 / ea
07-TWSCF	Heavy Duty Steel Rod for fixing - M20 x 400mm (x2)	\$59.90 / set	
07-WSCF-B	Light Duty Positioning Pin - M12 x 300mm (x2)	\$8.00 / set	
07-EB12	M12 lifting eye bolts (2 required)	\$19.90 / ea	

NEW

Galvanised Steel Wheel Stops For Trucks



- Curved Size: 2303(L) x 220(W) x 311(H)mm (Diameter 165mm)
- Flat Size: 2205(L) x 300(W) x 202(H)mm (Diameter 165mm)

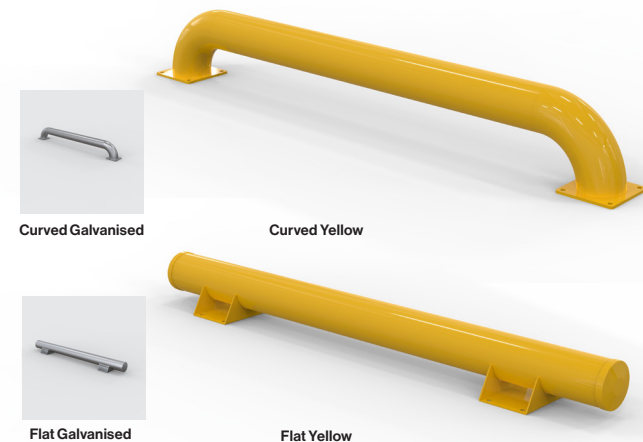

code	description	1+
07-STWSC-Y	Curved steel wheel stop for trucks - Yellow	\$1595.00 / ea
07-STWSC-G	Curved steel wheel stop for trucks - Galvanised	\$1495.00 / ea
07-STWSF-Y	Flat steel wheel stop for trucks - Yellow	\$929.00 / ea
07-STWSF-G	Flat steel wheel stop for trucks - Galvanised	\$899.00 / ea
08-GBM16110	Galvanised M16x110mm Sleeve Anchor with Washer (8 required per wheel stop)	\$4.20 / ea





How to install Rubber Wheel Stops



Preparing for Installation

To ensure a smooth installation process, preparation is crucial:

- Choose the Right Rubber Wheel Stops: Confirm they meet Australian standards (AS2890.1) for dimensions and placement. Rubber wheel stops are ideal for asphalt or concrete surfaces due to their flexibility and durability.
- Gather Tools: You'll need a hammer drill with masonry bits, chalk or a marker, bolts or spikes (provided with the stops), a wrench or socket set, and optional epoxy adhesive for added stability.
- Check Placement: Review placement guidelines to ensure proper spacing and alignment for safety and effectiveness.

Installation on Asphalt (Bitumen)

1. Clean the installation area.
2. Position the Wheel Stop or Template: Align the wheel stop according to AS2890.1:2004 guidelines, ensuring it is positioned 900–1100mm from the front edge of the parking space.
3. Drill pilot holes: Use a hammer drill with a Ø10mm bit to drill pilot holes through the fixing holes in the wheel stop or template, just penetrating through the bitumen layer.

4. Clean the area again.
5. Add adhesive (optional): Apply sealant adhesive to the underside of the wheel stop and into the pilot holes in the bitumen.
6. Secure the wheel stop: Position the wheel stop and hammer in M12 x 300mm galvanised fasteners, ensuring the heads are seated correctly in the recessed areas.

Installation on Concrete

1. Clean the area: Ensure the installation area is free from debris.
2. Position the Wheel Stop or Template: Align the wheel stop according to AS2890.1:2004 guidelines, ensuring it is positioned 900–1100mm from the front edge of the parking space.
3. Drill pilot holes: Use a hammer drill with a Ø10mm bit to drill pilot holes approximately 50mm deep through the wheel stop or template.
4. Drill final holes: Move the wheel stop or template aside and enlarge the pilot holes to Ø16mm and approximately 90mm deep.
5. Extract dust and clean again: Remove dust and debris from the drilled holes.
6. Add adhesive (optional): Apply sealant adhesive to the underside of the wheel stop.
7. Secure the wheel stop: Position the wheel stop and fasten it with M16 x 145mm D-bolts and washers, ensuring the tops of the fasteners are seated correctly in the recessed areas.



Scan the QR code to see our How To installation video on Youtube.

For more information or to explore Area Safe's range of rubber wheel stops, contact us today at www.areasafe.com.au



Which Speed Hump is best for me?

Speed humps are essential for slowing traffic and improving safety—but choosing the right material can be tricky. Here's a quick guide to help you decide between steel, rubber, and plastic speed humps based on your needs.

Steel Speed Humps

Built for: Heavy-duty environments like warehouses, industrial sites, and busy roads.

Advantages:

Extreme durability — Handles frequent heavy vehicles.
Long lifespan — Galvanised or powder-coated for rust resistance.

Secure install — Bolted down for maximum stability

Considerations:

Higher upfront cost (but long-term value).
Noisier under traffic.
Not easy to relocate

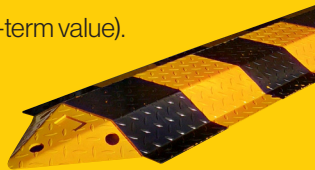

Plastic Speed Humps

Built for: Residential driveways, private roads, temporary setups, or light commercial use.

Advantages:

Lightweight & low-cost – Easy to install and move.
Weather-resistant – Doesn't rust or corrode.
Customisable – Various colours and modular designs available.

Considerations:

Not suitable for heavy vehicles.
Can wear or crack faster.
Must be securely anchored.



Rubber Speed Humps

Built for: Car parks, shopping centres, schools, and low-to-medium traffic roads.

Advantages:

Noise dampening – Softer impact means quieter operation.
Good visibility – Often includes bright reflective markings.
Quick install – Modular and easy to adjust or remove.

Considerations:

Wears faster under heavy loads.
May degrade under long-term UV exposure.
Not ideal for industrial-grade traffic

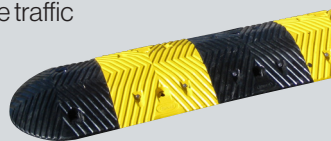

Which One Should You Choose?

Steel: For long-term, high-impact industrial use.

Rubber: For a flexible, quieter option in community or retail settings.

Plastic: For low-traffic zones or temporary installations.

Choosing the right speed hump helps manage traffic flow, protect pedestrians, and extend site longevity. Need help picking the right one? Contact our team today for expert advice.

Let me know if you want a version with your branding or product links embedded.

Rubber Speed Hump Features

1. UV resistant for colour consistency
2. 'Easy ride' profile
3. Inset reflectors for night visibility
4. Flexi Rubber for uneven surfaces
5. Heavy Duty

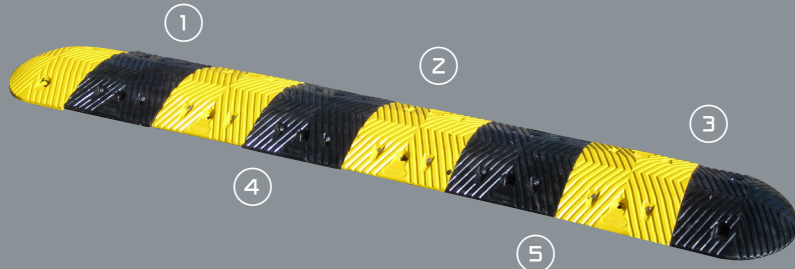

Plastic Speed Hump Features

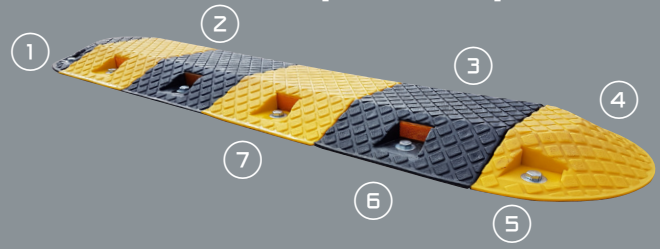

1. Recyclable HDPE
2. 100% Australian Standard Compliant
3. Heavy duty moulded plastic construction
4. Reinforced honeycomb core
5. Concealed fixing points
6. Inset reflectors for night visibility
7. Flat sides for effective speed control



Heavy Duty Solid Rubber Speed Hump For Cars & Trucks



- Material: Solid heavy duty rubber/PVC combination
- Size: 500(L)mm x 350(W)mm
- Weight: 15kg per metre



End Cap Modules

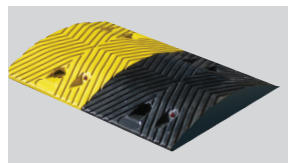

Centre Module

code	description	1-9	10+	30+
03-HSD500	Black/yellow module (2 per metre) 500(L) x 350(W) x 50(H)mm	\$119.00 / mtr	\$99.00 / mtr	\$85.00 / mtr
03-HSD5E	End cap set (Set/2) 250(L) x 350(W) x 50(H)mm	\$69.00 / set		
03-HERFC	Fasteners - concrete M12 x 65 D Bolts	\$12.90 / mtr		
03-HERFB	Fasteners - bitumen M14 x 75 Plug/CS	\$12.90 / mtr		
28-SBS	Sealant Adhesive 600ml	\$33.90 / ea		

Heavy Duty Plastic Speed Hump For Cars & Trucks



- Material: Tough UV stabilised HDPE plastic
- Modules: 250(L) x 350(W) x 50(H)mm
- End caps: 170(L) x 350(w) x 50(H)mm
- Weight: 7kg per metre

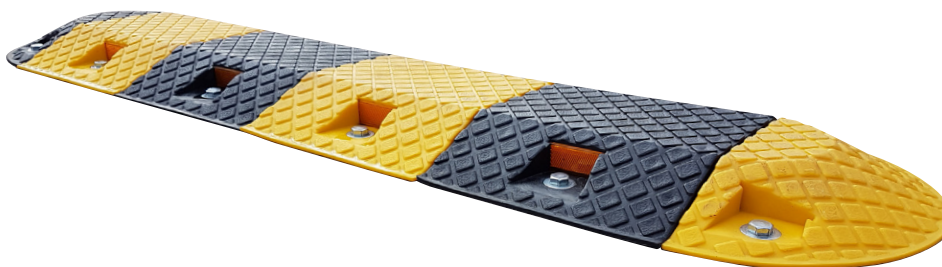

End Cap Modules

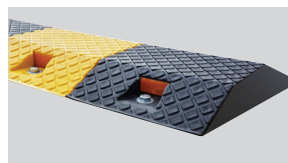

Centre Modules

✓ Complies with AS2890.1-2004

code	description	1-9	10+	30+
02-HPC	Black/yellow module (Minimum order 1m)	\$119.00 / mtr	\$99.00 / mtr	\$85.00 / mtr
02-HPCE	End cap set (Set/2)	\$69.00 / set		
02-HPCF	Fasteners M14 x 75 Plug/CS (Minimum order 1m)	\$12.90 / mtr		
28-SBS	Sealant Adhesive 600ml	\$33.90 / ea		



Heavy Vehicle Recycled Rubber Speed Hump 50mm for Trucks

- Material: Heavy duty recycled rubber
- Modules: 500(L) x 420(W) x 50(H)mm
- End Caps: 220 (L) x 420(W) x 50(H)mm
- Weight: 15kg per metre
- Cable channel underneath

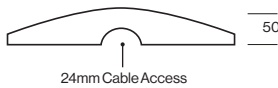

code	description	1+
05-HRR5	Black/yellow modules	\$159.00 / mtr
05-HRR5E	End cap set (Set/2)	\$99.00 / set
05-HRF75FC	Fasteners to suit concrete M12 x 80 D Bolts	\$12.90 / mtr
05-HRRFB	Fasteners to suit bitumen M14 x 75 Plug/CS	\$12.90 / mtr
28-SBS	Sealant Adhesive 600ml	\$33.90 / ea

Heavy Vehicle Recycled Rubber Speed Hump 75mm for Trucks



- Material: Heavy duty recycled rubber
- Module: 500(L) x 550(W) x 75(H)mm
- End Caps: 250(L) x 550(W) x 75(H)mm
- Weight: 30kg per metre

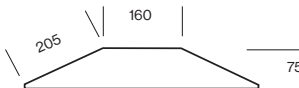

code	description	1+
03-HRF75	Black/yellow modules	\$199.00 / mtr
03-HRF75E	End cap set (Set/2)	\$125.00 / set
03-HRF75FC	Fasteners to suit concrete M12 x 80 D Bolts	\$12.90 / mtr
03-HRRFB75	Fasteners to suit bitumen M14 x 75 Plug/CS	\$12.90 / mtr
28-SBS	Sealant Adhesive 600ml	\$33.90 / ea

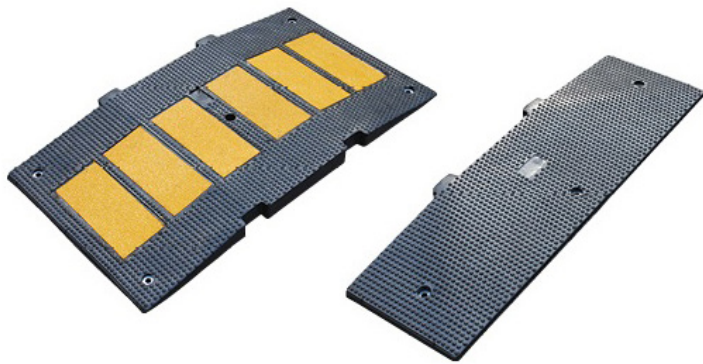

Rubber Speed Calmer 900mm Wide



- Material: Solid virgin rubber
- Height: 50mm - calming speed bump
- Modules: 500(L) x 900(W) x 50(H)mm
- End Cap: 270(L) x 900(W) x 50(H)mm
- Weight: 30kg per metre
- Made from Premium Recycled Rubber

code	description	1-9	10+
03-RSC	Black/yellow module	\$233.00 / mtr	\$215.00 / mtr
03-RSC-E	End cap set (set/2)	\$99.00 / set	
03-HRCFC	Fasteners to suit concrete (Pack of 12) M12 x 65 D Bolts	\$19.90 / Pack of 12	
03-HRCFB	Fasteners to suit bitumen (Pack of 12) M14 x 75 Plug/CS	\$19.90 / Pack of 12	
28-SBS	Sealant Adhesive 600ml	\$33.90 / ea	



Safety Rumble Strips



- Material: Solid rubber/PVC combination
- Height: 15mm - calming speed bump
- Size: 500(L) x 100(W) x 15(H)mm modules



code	description	1-29	30+
03-SRS-Y	Yellow modules	\$25.50 / ea	\$23.90 / ea
03-SRS-B	Black modules	\$25.50 / ea	\$23.90 / ea

Premium Steel Speed Hump Features

1. Heavy 5mm Wall thickness
2. Stronger Flanged mounting points
3. 100% Australian standard compliant
4. Powder Coated Black Sections (not sprayed over)
5. Powder Coated Yellow Sections
6. Large cable channel
7. Double reinforcing gussets
8. Individual 1m modules
9. Flush gussets prevent leverage on fixings
10. Cable channel
11. Wider footprint makes more secure fixings

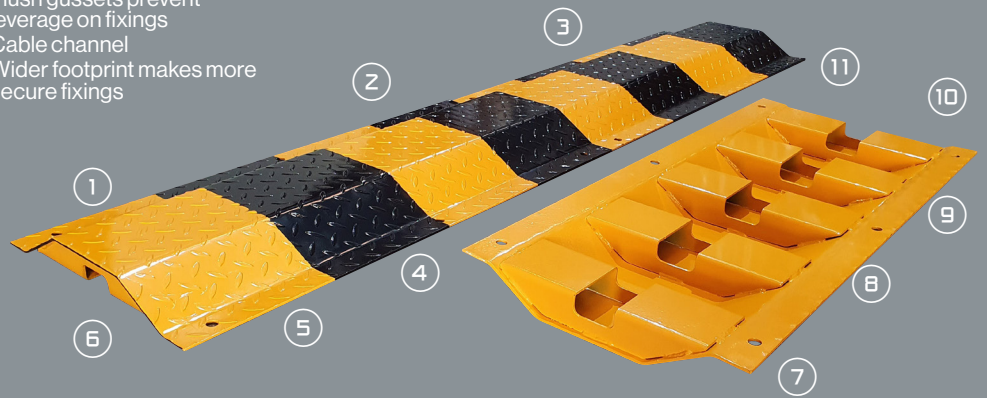



Steel Speed Hump 3mm Plate

- Material: 3mm steel plate
- Treatment: Hot-dipped galvanised
- Finish: Powder-coated checker plate
- Modules: 1000(L) x 450(W) x 60(H)mm
- End caps: 210(L) x 343(W) x 56(H)mm
- Weight: 19kg per metre
- Cable channel: 30(H) x 65(W)mm

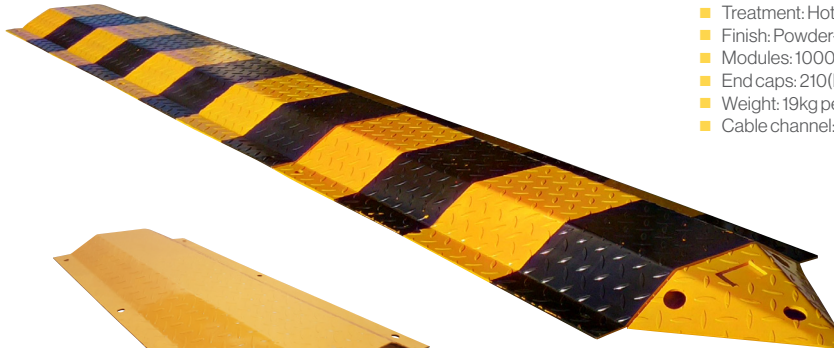

02-SMWY
Plain Yellow Option



02-SMWE
End Cap Modules

✓ Complies with AS2890.1-2004

code	description	1-9	10+
02-SMW	Black & Yellow Module - 1m	\$277.00 / mtr	\$245.00 / mtr
02-SMWY	Plain Yellow Module - 1m (DISCONTINUED LINE - PRICE TO CLEAR STOCK)	\$149.00 / mtr	
02-SMWE	Steel End Cap (Set/2)	\$149.00 / set	
02-HMFC	Fasteners - concrete	\$12.90 / mtr	
02-HMFB	Fasteners - bitumen	\$12.90 / mtr	
28-SBS	Sealant Adhesive 600ml	\$33.90 / ea	

Steel Speed Hump 5mm Plate

- Material: 5mm steel plate
- Treatment: Hot-dipped galvanised
- Finish: Powder-coated checker plate
- Modules: 1000(L) x 450(W) x 60(H)mm
- End caps: 210(L) x 343(W) x 56(H)mm
- Weight: 26kg per metre
- Cable channel: 30(H) x 65(W)mm



02-HMWE
End Cap Modules

✓ Complies with AS2890.1-2004

code	description	1-9	10+
02-HMW	Heavy Duty Module - 1m (Black/Yellow)	\$349.00 / mtr	\$319.00 / mtr
02-HMWE	Steel End Cap (Set/2)	\$149.00 / set	
02-HMFC	Fasteners - concrete	\$12.90 / mtr	
02-HMFB	Fasteners - bitumen	\$12.90 / mtr	
28-SBS	Sealant Adhesive 600ml	\$33.90 / ea	

Expansion Joint Cover Features

- 1. Slotted holes
- 2. 5mm plate thickness
- 3. Hot dip galvanised — never rusts
- 4. Humped option for cable access or waterproofing protection
- 5. Checker plate option provides slip-resistance
- 6. Flat area around slots for free movement
- 7. Humped smooth
- 8. Flat checker
- 9. Noise silencing
- 10. Rubber underlay
- 11. 4.5mm thick
- 12. 2-ply reinforced to ensure it won't break down
- 13. Rubber is standard with all covers
- 14. Correct density to withstand friction

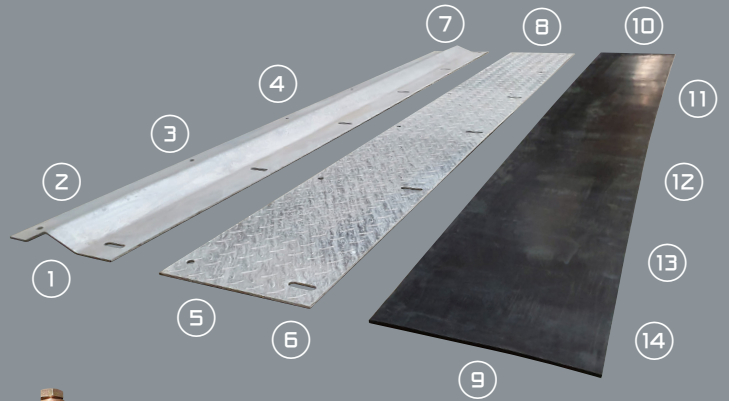

Correct fittings supplied with cover

Expansion Joint Cover - Humped Smooth

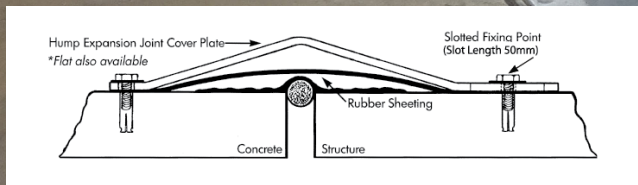
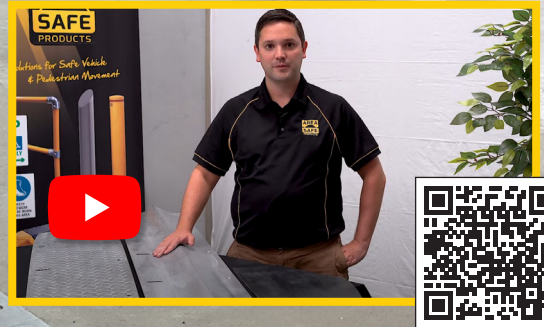

Expansion Joint Cover - Humped Smooth

Expansion Joint Cover - Humped Checker Plate

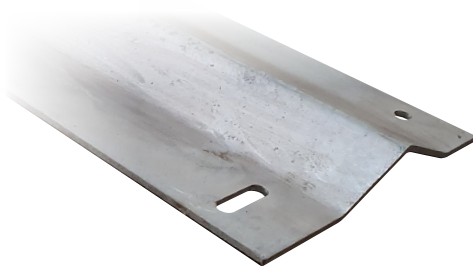

Expansion Joint Cover - Humped Smooth



- Thickness: 5mm plate
- Size: 2400(L) x 285(W)mm
- Fixing Points: Slot is 50 x 14mm, Hole Ø14mm
- Clearance: 25mm under hump
- Underlay: 4.5mm fibre reinforced insertion rubber
- Fixings: M12 x 65mm flush head bolt and washer
- Weight: 27kg/ea

code	description	1-19	20+
32-HEJ-24	Humped Smooth Cover Kit - (Cover, Underlay, Fixings)	\$365.00 / ea	\$335.00 / ea
-32-HEJ-24	Humped Smooth Cover Only	\$315.00 / ea	\$299.00 / ea



Expansion Joint Cover - Humped Checker Plate



- Thickness: 5mm plate
- Size: 2400(L) x 285(W)mm
- Fixing Points: Slot is 50 x 14mm, Hole Ø14mm
- Clearance: 25mm under hump
- Underlay: 4.5mm fibre reinforced insertion rubber
- Fixings: M12 x 65mm flush head bolt and washer
- Weight: 27kg/ea

code	description	1-19	20+
32-HEJ-CP	Humped Checker Cover Kit - (Cover, Underlay, Fixings)	\$375.00 / ea	\$355.00 / ea
-32-HEJ-CP	Humped Checker Cover Only	\$329.00 / ea	\$315.00 / ea



Expansion Joint Covers - Flat Smooth



- Thickness: 5mm plate
- Size: 2400(L) x 297(W) mm
- Fixing Points: Slot is 50 x 14mm, Hole Ø14mm
- Underlay: 4.5mm fibre reinforced insertion rubber
- Fixings: M12 x 65mm flush head bolt and washer
- Weight: 27kg/ea

code	description	1-19	20+
32-FEJ-24	Flat Smooth Cover Kit - (Cover, Underlay, Fixings)	\$319.00 / ea	\$285.00 / ea
-32-FEJ-24	Flat Smooth Cover Only	\$279.00 / ea	\$249.00 / ea



Expansion Joint Covers - Flat Checker Plate



- Thickness: 5mm plate
- Size: 2400(L) x 297(W) mm
- Fixing Points: Slot is 50 x 14mm, Hole Ø14mm
- Underlay: 4.5mm fibre reinforced insertion rubber
- Fixings: M12 x 65mm flush head bolt and washer
- Weight: 27kg/ea

code	description	1-19	20+
32-FEJ-CP	Flat Checker Cover Kit - (Cover, Underlay, Fixings)	\$339.00 / ea	\$299.00 / ea
-32-FEJ-CP	Flat Checker Cover Only	\$289.00 / ea	\$265.00 / ea



Fixed Steel Bollards - Yellow - In-ground - 90mm (See Page 25)



Fixed Steel Bollards - White Satin - In-ground - 140mm (See Page 25)



Fixed Steel Bollards - Yellow - Base Plate - 140mm (See Page 24)



Steel Bollards - Galvanised - Base Plate - 140mm (See Page 28)

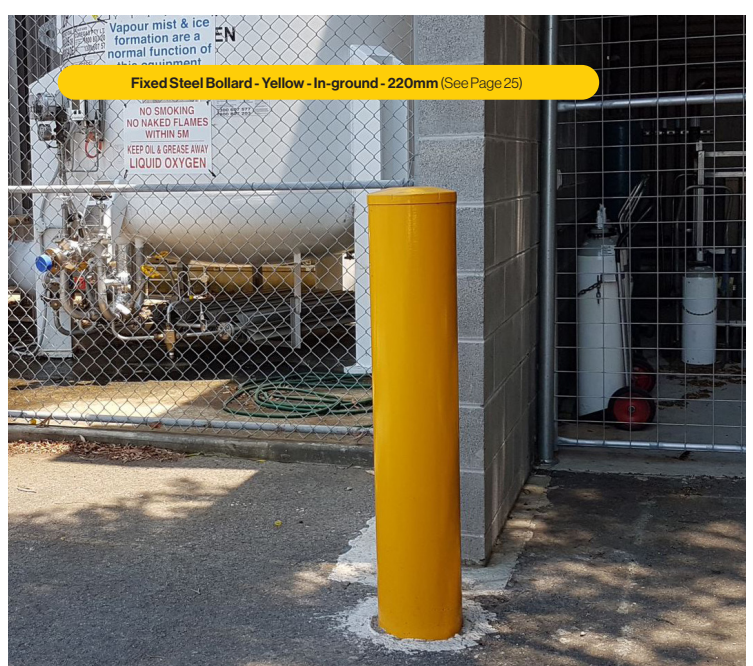

Fixed Steel Bollard - Yellow - In-ground - 220mm (See Page 25)



Area Safe steel bollards are essential for separating pedestrians from vehicles and for protecting property. Bollards are a legal requirement for accessible parking shared zones and for preventing obstruction of fire egress doors. Standard powder coat colour is safety yellow — other colours made to order (please enquire).

- **Optional chain rings available**
- **Standard colour is safety yellow**
- **Other colours available - See Pages 18-19**
- **Custom bollards - POA**

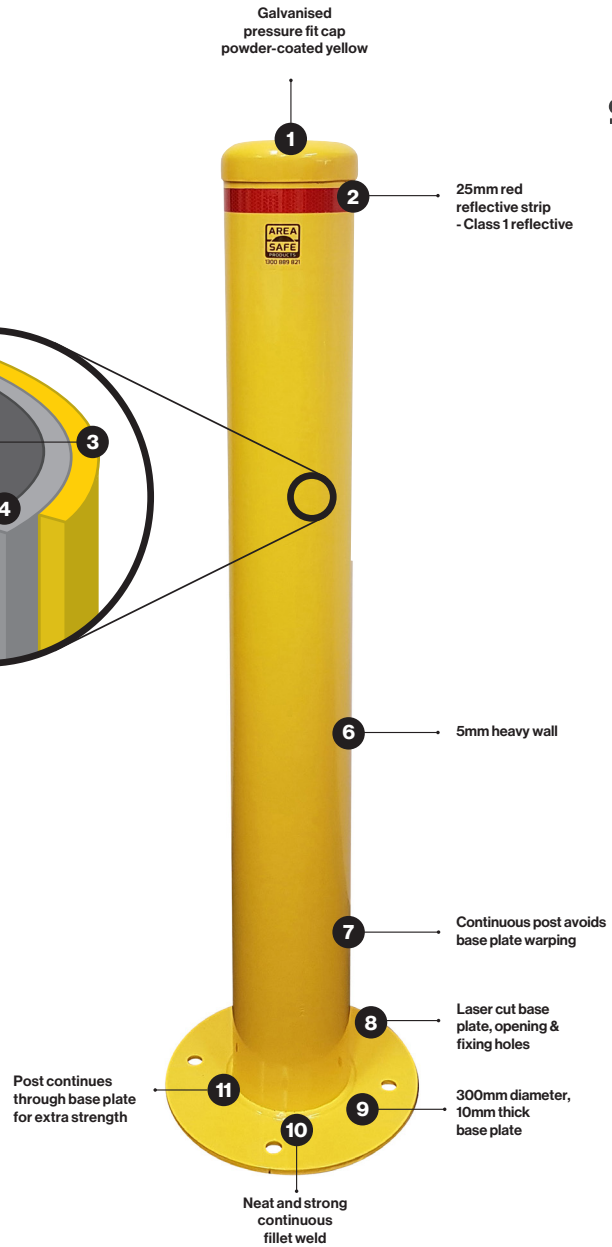
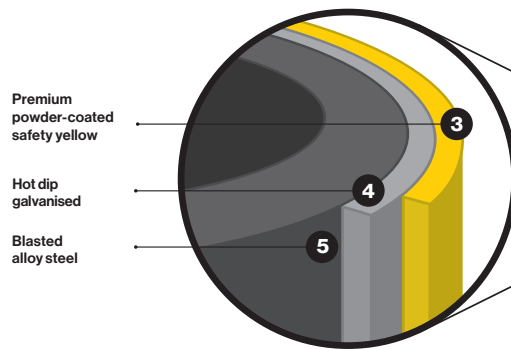

Area Safe Premium Bollards		
✓	Galvanised pressure fit cap powder-coated yellow	1
✓	25mm red reflective Strip - class 1 reflective	2
✓	Premium powder-coated Safety yellow, gloss	3
✓	Hot dip galvanised	4
✓	Blasted alloy steel	5
✓	5mm heavy wall	6
✓	Continuous post avoids base plate warping	7
✓	Laser cut base plate, Opening & fixing holes	8
✓	300mm diameter, 10mm thick base plate	9
✓	Neat and strong 3mm CFW electronic weld	10
✓	Post continues through base plate for extra strength	11



Fixed Steel Bollards Yellow (Base Plate)



code	description	1-10	11-25	26+
08-SF75BP	Fixed Base Plate Bollard (Round base plate & Black Plastic Cap) 3mm Wall - Ø75 x 900(H)mm - 8kg	\$142.90 / ea	\$118.90 / ea	\$POA
08-SF90BP	Fixed Base Plate Bollard (Round base plate), 5mm Wall - Ø90 x 900(H)mm - 10kg	\$194.90 / ea	\$176.90 / ea	\$POA
08-SF115BP	Fixed Base Plate Bollard (DDA - Round base plate) 3mm Wall - Ø115 x 1300(H)mm - 12kg	\$219.90 / ea	\$199.90 / ea	\$POA
08-SF140BP	Fixed Base Plate Bollard (Round base plate) 5mm Wall - Ø140 x 1200(H)mm - 25kg	\$299.00 / ea	\$286.00 / ea	\$POA
09-SF165BP	Fixed Base Plate Bollard (Square base plate) 5mm Wall - Ø165 x 1200(H)mm - 30kg	\$369.00 / ea	\$349.00 / ea	\$POA
09-SF220BP	Fixed Base Plate Bollard (Round base plate) 5mm Wall - Ø220 x 1200(H)mm - 50kg	\$729.00 / ea		
08-GSB1275X4	M12 x 75mm Galvanised Screw Bolt - Set of 4 (Suits 75mm, 90mm, 115mm Bollards)	\$9.90 / set		
08-GSB16100X4	M16 x 100mm Galvanised Screw Bolt - Set of 4 (Suits 140mm, 165mm, 220mm Bollards - 220mm require 5 bolts)	\$23.90 / set		

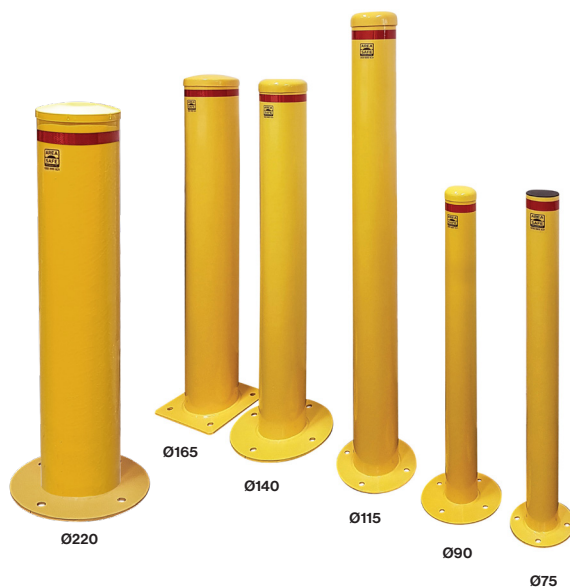

Fixed Steel Bollards Black (Base Plate)



- Made to order - lead time applies
- Other colours available - please enquire
- Red reflective tape is supplied loose

code	description	1+
08-BL90BP	Fixed Base Plate Bollard (Round base plate) 5mm Wall - Ø90 x 900(H)mm - 10kg	\$209.90 / ea
08-BL115BP	Fixed Base Plate Bollard (Round Base Plate) 3mm Wall - Ø115 x 1300(H)mm - 12kg	\$299.00 / ea
08-BL140BP	Fixed Base Plate Bollard (Round base plate) 3mm Wall - Ø140 x 1200(H)mm - 25kg	\$319.00 / ea
09-BL165BP	Fixed Base Plate Bollard (Square base plate) 5mm Wall - Ø165 x 1200(H)mm - 30kg	\$385.00 / ea
08-GSB1275X4	M12 x 75mm Galvanised Screw Bolt - Set of 4 (Suits 90mm, 115mm Bollards)	\$9.90 / Set
08-GSB16100X4	M16 x 100mm Galvanised Screw Bolt - Set of 4 (Suits 140mm, 165mm Bollards)	\$23.90 / Set



Fixed Steel Bollards Custom Colour (Base Plate)



- Pricing below applicable to below colours only (other colours available \$POA)

	Charcoal		Notre Dame		Signal Red
	Monument		Apo Grey		Blaze Blue
	Anotec Dark Grey		White Satin		Mistletoe
	Woodland Grey		Orange X15		

code	description	1-4	5+
08-CB90BP-COLOUR	Fixed Base Plate Bollard (Round base plate) 5mm Wall - Ø90 x 900(H)mm - 10kg	\$325.00 / ea	\$249.00 / ea
08-CB115BP-COLOUR	Fixed Base Plate Bollard (Round Base Plate) 3mm Wall - Ø115 x 1300(H)mm - 12kg	\$359.00 / ea	\$299.00 / ea
08-CB140BP-COLOUR	Fixed Base Plate Bollard (Round base plate) 5mm Wall - Ø140 x 1200(H)mm - 25kg	\$465.00 / ea	\$359.00 / ea
09-CB165BP-COLOUR	Fixed Base Plate Bollard (Square base plate) 5mm Wall - Ø165 x 1200(H)mm - 30kg	\$510.00 / ea	\$395.00 / ea
08-GSB1275X4	M12 x 75mm Galvanised Screw Bolt - Set of 4, (Suits 90mm, 115mm Bollards)	\$9.90 / set	
08-GSB16100X4	M16 x 100mm Galvanised Screw Bolt - Set of 4 (Suits 140mm, 165mm Bollards)	\$23.90 / set	

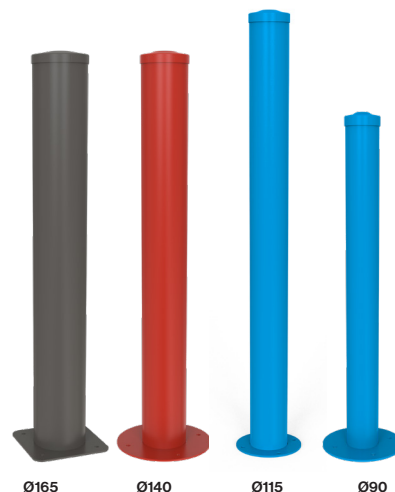

Fixed Steel Bollards Yellow (In-ground)



- Caps and reflective tape supplied loose

code	description	1-10	11-25	26+
08-SF90IG	Fixed In-ground Bollard 5mm Wall - Ø90 x 1300(H)mm(Overall) - 13kg	\$219.90 / ea	\$194.90 / ea	\$POA
08-SF115IG	Fixed In-ground Bollard 5mm Wall - Ø115 x 1625(H)mm (Overall) - 13kg	\$219.00 / ea		
08-SF140IG	Fixed In-ground Bollard 5mm Wall - Ø140 x 1625(H)mm(Overall) - 30kg	\$329.00 / ea	\$309.00 / ea	\$POA
09-SF165IG	Fixed In-ground Bollard 5mm Wall - Ø165 x 1625(H)mm(Overall) - 35kg	\$399.00 / ea	\$382.00 / ea	\$POA
09-SF220IG	Fixed In-ground Bollard 5mm Wall - Ø220 x 1800(H)mm(Overall) - 50kg	\$POA		



Fixed Steel Bollards Black (In-ground)



- Made to order — lead time applies
- Other colours available — please enquire
- Caps and reflective tape supplied loose

code	description	1+
08-BL90IG	Fixed In-ground Bollard 5mm Wall - Ø90 x 1300(H)mm(Overall) - 13kg	\$232.00 / ea
08-BL115IG	Fixed In-ground Bollard 5mm Wall - Ø115 x 1625(H)mm (Overall) - 13kg	\$299.00 / ea
08-BL140IG	Fixed In-ground Bollard 5mm Wall - Ø140 x 1625(H)mm(Overall) - 30kg	\$355.00 / ea
09-BL165IG	Fixed In-ground Bollard 5mm Wall - Ø165 x 1625(H)mm(Overall) - 35kg	\$429.00 / ea



Fixed Steel Bollards Custom Colour (In-ground)



- Pricing below applicable to below colours only (other colours available \$POA)

	Charcoal		Notre Dame		Signal Red
	Monument		Apo Grey		Blaze Blue
	Anotec Dark Grey		White Satin		Mistletoe
	Woodland Grey		Orange X15		

code	description	1 - 4	5+
08-CB90IG-COLOUR	Fixed In-ground Bollard - Custom Colour 5mm Wall - Ø90 x 1300(H)mm(Overall) - 13kg	\$359.00 / ea	\$275.00 / ea
08-CB115IG-COLOUR	Fixed Base Plate Bollard (Round Base Plate) 5mm Wall - Ø115 x 1625(H)mm - 13kg	\$389.00 / ea	\$299.00 / ea
08-CB140IG-COLOUR	Fixed In-ground Bollard 5mm Wall - Ø140 x 1625(H)mm(Overall) - 30kg	\$515.00 / ea	\$395.00 / ea
09-CB165IG-COLOUR	Fixed In-ground Bollard 5mm Wall - Ø165 x 1625(H)mm(Overall) - 35kg	\$595.00 / ea	\$469.00 / ea

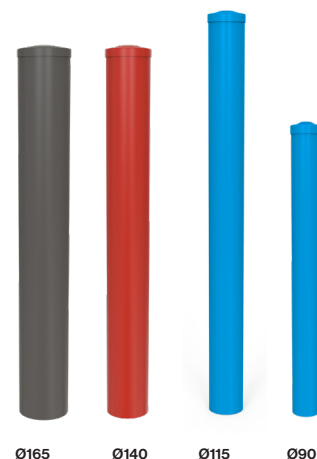

Compliant Shared Zone

car park compliance
how to specify correctly

CPD Car Park Compliance Course
Scan QR to see online page

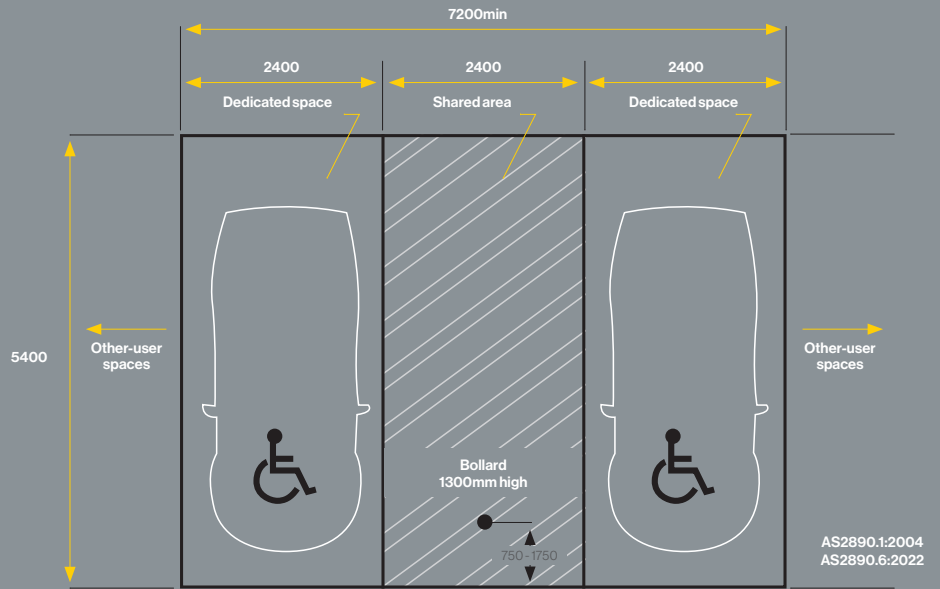
Fixed Steel Bollards - Yellow - 140mm (See Page 24)



Fixed Steel Bollards - Yellow - 140mm (See Page 24)



Fixed Steel Bollards In Ground - Yellow - 140mm (See Page 25)



Shared Zone Bollard - Base Plate Yellow - 115mm





Shared Zone Bollards Base Plate

- Compliant 1300mm High
- Compliant 300mm Wide Red Reflective Strip (supplied loose)
- Colours: Yellow, Black, Blue or Plain Galvanised
- Diameter: 115mm

code	description	price
08-SF115BP-SZ	Yellow	\$259.90 / ea
08-BL115BP-SZ	Black	\$339.00 / ea
08-CB115BP-BLU-SZ	Blue	\$339.00 / ea
08-B115BP-SZ	Plain Galvanised	\$238.00 / ea
08-GSB1275X4	M12 x 75mm Galvanised Screw Bolt - Set of 4	\$9.90 / Set

✓ New Parking Australian Standards AS2890.6:2022 affect Shared Zone Bollards - Area Safe Bollards now compliant!

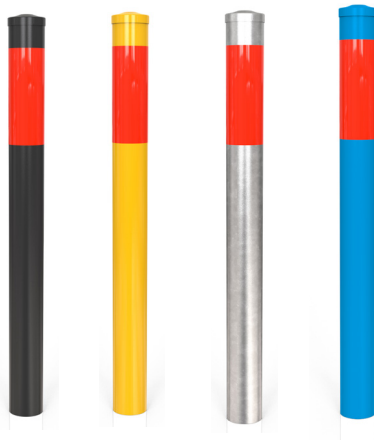

Shared Zone Bollards In-ground

- Compliant 1300mm High (Overall height 1625mm)
- Compliant 300mm High Red Reflective Strip (supplied loose)
- Colours: Yellow, Black, Blue or Plain Galvanised
- Diameter: 115mm

code	description	price
08-SF115IG-SZ	Yellow	\$259.00 / ea
08-BL115IG-SZ	Black	\$339.00 / ea
08-CB115IG-BLU-SZ	Blue	\$339.00 / ea
08-B115IG-SZ	Plain Galvanised	\$238.00 / ea

✓ New Parking Australian Standards AS2890.6:2022 affect Shared Zone Bollards - Area Safe Bollards now compliant!



Compliant Shared Zone Bollard Reflective

- Reflective Strip to apply to old or existing bollards
- 300(H) x 450(W)mm - Suits up to 140mm diameter bollards
- Red Microprismatic Retroreflective sheet

code	description	price
08-SZBR300	300(H) x 450(W)mm	\$39.90 / ea

✓ New Parking Australian Standards AS2890.6:2022 affect Shared Zone Bollards - Area Safe Bollards now compliant!

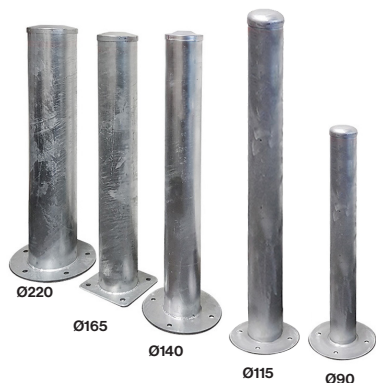

Steel Bollards Gal Finish (Base Plate)

- Reflective tape supplied loose



code	description	1-10	11-25	26+
08-B90BP	Fixed Base Plate Bollard (Round base plate) 5mm Wall - Ø90 x 900(H)mm - 10kg	\$148.50 / ea	\$129.90 / ea	\$119.90 / ea
08-B115BP	Fixed Base Plate Bollard (Round Base Plate) 3mm Wall - (Ø)115 x 1300(H)mm - 12kg	\$199.00 / ea	\$192.00 / ea	\$179.00 / ea
08-B140BP	Fixed Base Plate Bollard (Round base plate) 5mm Wall - Ø140 x 1200(H)mm - 25kg	\$269.90 / ea	\$245.90 / ea	\$229.90 / ea
09-B165BP	Fixed Base Plate Bollard (Square base plate) 5mm Wall - Ø165 x 1200(H)mm - 30kg	\$329.00 / ea	\$299.00 / ea	\$289.00 / ea
09-B220BP	Fixed Base Plate Bollard (Round base plate) 5mm Wall - Ø220 x 1200(H)mm - 50kg	\$POA		
08-GSB1275X4	M12 x 75mm Galvanised Screw Bolt - Set of 4 (Suits 90mm, 115mm Bollards)	\$9.90 / Set		
08-GSB16100X4	M16 x 100mm Galvanised Screw Bolt - Set of 4 (Suits 140mm, 165mm, 220mm Bollards - 220mm require 5 bolts)	\$23.90 / Set		



Steel Bollards Gal Finish (In-ground)

- Reflective tape supplied loose



code	description	1-10	11-25	26+
08-B90IG	Fixed In-ground Bollard 5mm Wall - Ø90 x 1300(H)mm(Overall) - 13kg	\$165.00 / ea	\$142.00 / ea	\$128.00 / ea
08-B115IG	Fixed In-ground Bollard 5mm Wall - Ø115 x 1625(H)mm(Overall) - 13kg	\$199.00 / ea		
08-B140IG	Fixed In-ground Bollard 5mm Wall - Ø140 x 1625(H)mm(Overall) - 30kg	\$299.00 / ea	\$272.00 / ea	\$255.00 / ea
09-B165IG	Fixed In-ground Bollard 5mm Wall - Ø165 x 1625(H)mm(Overall) - 35kg	\$362.00 / ea	\$335.00 / ea	\$315.00 / ea
09-B220IG	Fixed In-ground Bollard 5mm Wall - Ø220 x 1800(H)mm(Overall) - 50kg	\$POA		



Architectural Steel Bollards with Apollo Cap Base Plate

- Heavy duty galvanised steel safety bollards with polished aluminium Apollo cap
- Size: Ø165 x 1350(H)mm
- Weight: 30kg
- Red reflective tape is supplied loose



code	description	1+
09-B165BP-A	Galvanised finish	\$497.90 / ea
09-SF165BP-A	Yellow powder coat	\$537.90 / ea
09-BL165BP-A	Black powder coat	\$553.90 / ea
09-CB165BP-A-COLOUR	Custom Colour Powder Coat (See Page 19 for available colours)	\$563.90 / ea
08-GSB16100X4	M16 x 100mm Galvanised Screw Bolt - Set of 4	\$23.90 / Set



Architectural Steel Bollards with Apollo Cap In-ground

- Heavy duty galvanised steel safety bollards with polished aluminium Apollo cap
- Size: Ø165 x 1770(H)mm overall
- Weight: 35kg
- Reflective tape supplied loose



code	description	1+
09-B165IG-A	Galvanised Finish	\$529.00 / ea
09-SF165IG-A	Yellow Powder Coat	\$567.90 / ea
09-BL165IG-A	Black Powder Coat	\$597.90 / ea
09-CB165IG-A-COLOUR	Custom Colour Powder Coat (See Page 19 for available colours)	\$637.70 / ea

Apollo Polished Dome Cap

- Polished aluminium
- Size: Ø165 x 150(H)mm
- Factory fitting available – see price block
- Can be retro-fitted on site by others



code	description	1-10	11-25	26+
09-ADT165	Apollo Dome Cap	\$129.00 / ea	\$109.00 / ea	\$99.00 / ea
08-CR-FIT	Factory Fitting Cost	\$45.90 / ea		

Plastic Bollard Covers

- Pop over existing damaged bollards
- Saves painting old bollards
- Supplied with foam packers



code	description	1+
08-PBS100	101.6(NB) x 1320(H)mm - Suits 90-100(OD)mm bollards	\$59.00 / ea
08-PBS150	152(NB) x 1320(H)mm - Suits 140(OD)mm bollards	\$69.00 / ea
08-PBS175	177(NB) x 1320(H)mm - Suits 165(OD)mm bollards	\$85.00 / ea

Chain Ring

- Size: Ø45mm
- Thread: M10



code	description	1+
08-SCH-CR	Chain Ring	\$15.90 / ea
08-CR-FIT	Factory Fitting Cost	\$45.90 / ea

D-Shackle

- To suit 6mm chain
- Size: 38(L) x 25(W)mm



code	description	1+
08-SCH-DS	D-Shackle	\$6.20 / ea

Galvanised Steel & Plastic Chain

- Size: 6mm gal chain with 22x35mm links
- Plastic Chains only available in 40m rolls
- Galvanised chain length: Cut to any length (Max:30m)
- Custom powder coat colours available – please enquire.



code	description	1+
08-SCH-GAL	Galvanised Chain	\$16.50 / mtr
08-SCH-PC	Galvanised Chain - Powder Coated Yellow	\$24.80 / mtr
24-PLC640M	Plastic Chain - Yellow 40m	\$139.00 / ea
24-PLC640M-W	Plastic Chain - White 40m	\$139.90 / ea

Hi-Vis Chain Sleeve Reflective

- High-vis class 1 reflective (Red)
- 2m length or 20m roll
- Suits 6mm chain



code	description	1+
08-RCS	2m length	\$59.90 / length
08-RCS-20	20m Roll	\$449.00 / roll

Key Operated In-ground Removable Bollard Features

1. 25mm red class 1 reflective strip
2. Heavy 5mm wall thickness
3. Heavy duty gal sleeve
4. Fixed security cap with handle
5. Heavy duty security key
6. Unique locking system

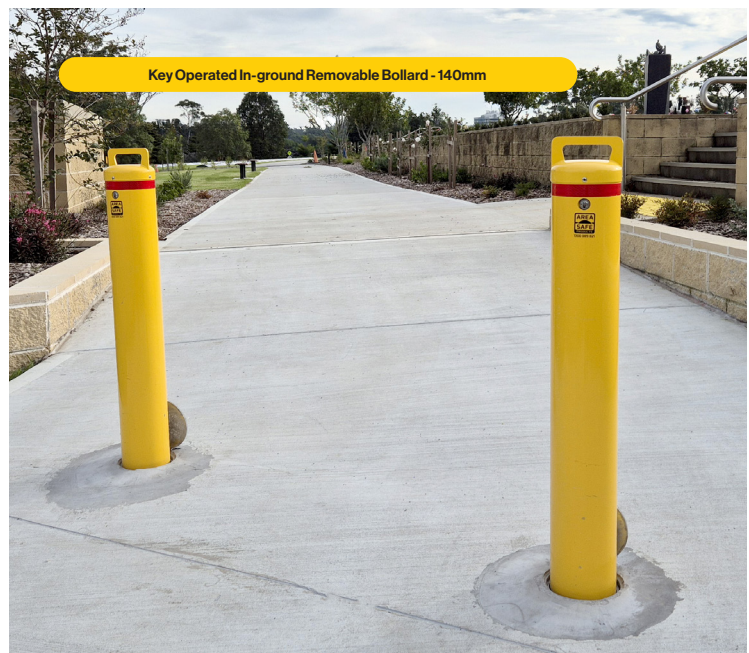
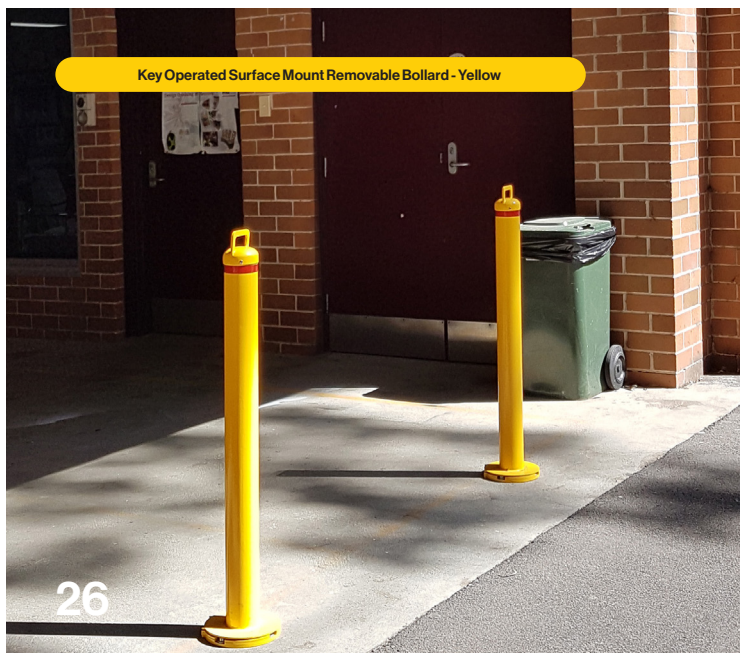
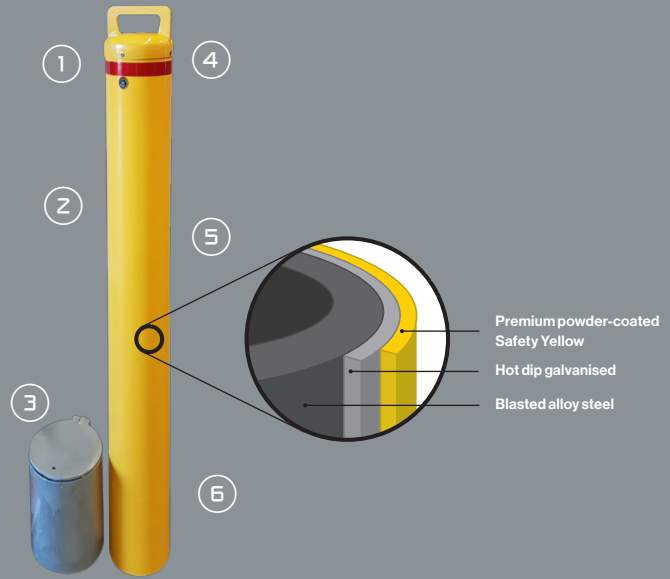

Key Operated Surface Mount Removable Bollard - Yellow

- Bollard: Ø90 x 1020(H)mm
- Receiver Shoe: 200(W) x 18(H)mm
- Weight: 14kg

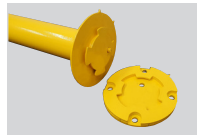

Storage Shoe



Storage Shoe



code	description	1-4	5+
09-SRSMK	Bollard & Receiver Shoe	\$319.00 / ea	\$299.00 / ea
09-SRSMK-B	Storage Shoe - Yellow	\$98.00 / ea	
09-FHSA	M12 x 65 Flush Head anchors (Set of 4)	\$9.00 / set	

code	description	1-4	5+
09-SRSMK-BL	Bollard & Receiver Shoe	\$349.00 / ea	\$319.00 / ea
09-SRSMK-BBL	Storage Shoe - Black	\$109.00 / ea	
09-FHSA	M12 x 65 Flush Head anchors (Set of 4)	\$9.00 / set	

Key Operated In-ground Removable Bollard - 90mm

- Bollard: Ø90 x 950(H)mm (Overall length: 1150mm)
- Weight: 12kg bollard + 3kg sleeve



Bolt-down Storage Sleeve



code	description	1-4	5+
09-SRK90	Bollard & Sleeve	\$365.00 / ea	\$329.00 / ea
09-SRK90-BDS	Bolt-down Storage Sleeve	\$149.00 / ea	

Key Operated In-ground Removable Bollard - 140mm

- Bollard: Ø140 x 950(H)mm (Overall length: 1150mm)
- Weight: 18kg bollard + 6kg sleeve



Bolt-down Storage Sleeve



code	description	1-4	5+
09-SRK140	Bollard & Sleeve	\$499.00 / ea	\$455.00 / ea
09-SRK140-BDS	Bolt-down Storage Sleeve	\$199.00 / ea	

Padlock In-ground Removable Bollard Features

1. 25mm red class 1 reflective strip
2. Heavy 5mm wall thickness
3. Heavy duty gal sleeve
4. Fixed security cap with handle
5. Heavy duty padlock lug

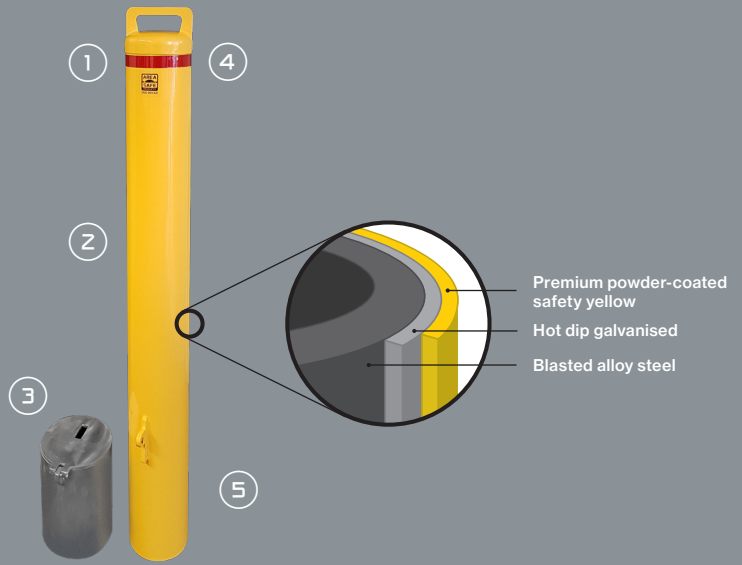

Padlock Secured In-ground Removable Bollards - 90mm - Yellow

- Bollard: Ø90 x 950(H)mm (above ground)
- Weight: 12kg bollard + 3kg sleeve

Bolt-down Storage Sleeve



code	description	1-4	5+
09-SRP90	Bollard & Sleeve (Yellow)	\$299.00 / ea	\$259.00 / ea
09-SRK90-BDS	Bolt-down Storage Sleeve	\$149.00 / ea	

Padlock Secured In-ground Removable Bollards - 140mm - Yellow

- Bollard: Ø140 x 1050(H)mm (above ground)
- Weight: 18kg + 6kg sleeve

Bolt-down Storage Sleeve



code	description	1-4	5+
09-SRP140	Bollard & Sleeve (Yellow)	\$469.00 / ea	\$445.00 / ea
09-SRK140-BDS	Bolt-down Storage Sleeve	\$199.00 / ea	

Padlock Secured In-ground Removable Bollards - 90mm - Black

- Bollard: Ø90 x 950(H)mm (above ground)
- Weight: 12kg bollard + 3kg sleeve

Bolt-down Storage Sleeve



code	description	1-4	5+
09-SRP90-BK	Bollard & Sleeve (Black)	\$349.00 / ea	\$319.00
09-SRK90-BDS	Bolt-down Storage Sleeve	\$149.00 / ea	

Padlock Secured In-ground Removable Bollards - 140mm - Black

- Bollard: Ø140 x 1050(H)mm (above ground)
- Weight: 18kg + 6kg sleeve

Bolt-down Storage Sleeve



code	description	1-4	5+
09-SRP140-BK	Bollard & Sleeve (Black)	\$499.00 / ea	\$469.00 / ea
09-SRK140-BDS	Bolt-down Storage Sleeve	\$199.00 / ea	

Padlock Secured In-ground Removable Bollards - 90mm - Galvanised

- Bollard: Ø90 x 950(H)mm (above ground)
- Weight: 12kg bollard + 3kg sleeve

Bolt-down Storage Sleeve



code	description	1-4	5+
09-SRP90-G	Bollard & Sleeve (GalFinish)	\$279.00 / ea	\$249.00 / ea
09-SRK90-BDS	Bolt-down Storage Sleeve	\$149.00 / ea	

Padlock Secured In-ground Removable Bollards - 140mm - Galvanised

- Bollard: Ø140 x 1050(H)mm (above ground)
- Weight: 18kg + 6kg sleeve

Bolt-down Storage Sleeve



code	description	1-4	5+
09-SRP140-G	Bollard & Sleeve (GalFinish)	\$439.00 / ea	\$399.00 / ea
09-SRK140-BDS	Bolt-down Storage Sleeve	\$199.00 / ea	

Traditional Parking Space Protector Features

1. Easy to use padlock gusset
2. Heavy duty 3mm wall thickness
3. Strong tubular design
4. 8 fixing points for extra security
5. Strong security pivot points
6. Wide footprint for better car space protection
7. Folds down for low clearance
8. Hi-Vis safety yellow finish

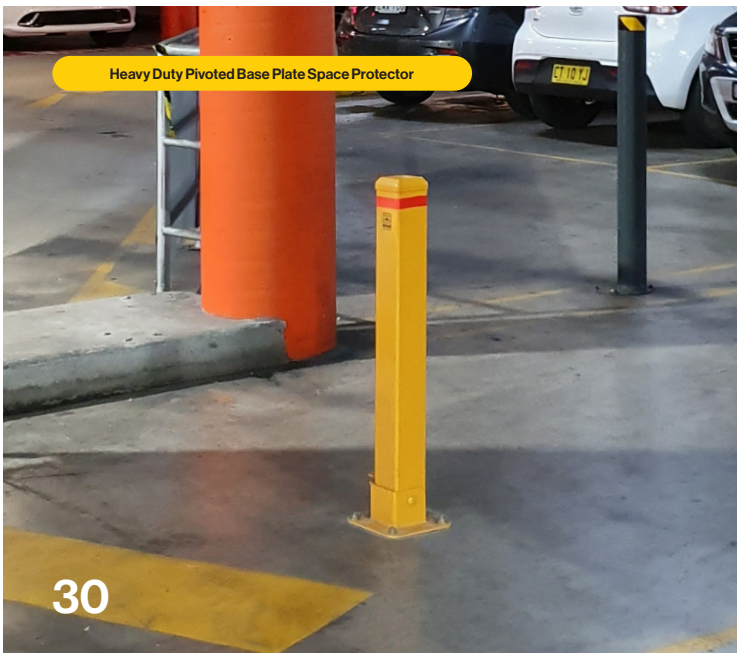
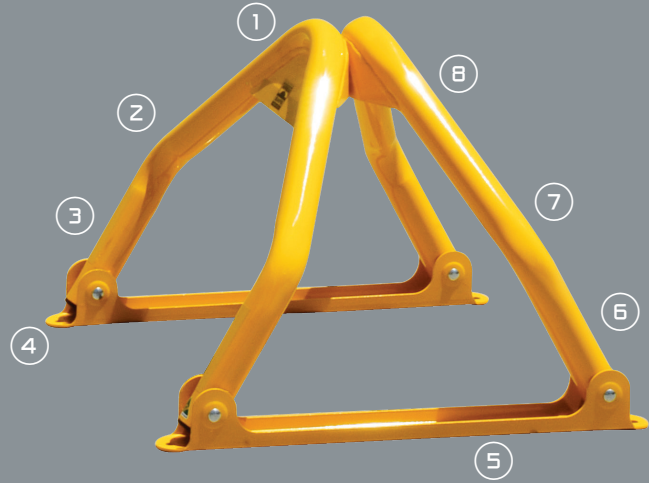

Key Operated Parking Space Protector - Round

- Height: 670mm / 85mm
- Post: Ø60mm
- All keyed alike
- Weight: 6kg



code	1-5	6+
16-KOSP-R	\$219.00 / ea	\$189.00 / ea



Heavy Duty Pivoted Base Plate Bollard / Space Protector

- Height: 800mm / 102mm
- Post: 90 x 90mm
- Wall: 5mm
- Weight: 10kg

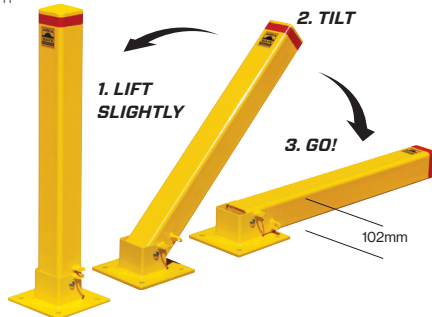

code	1-5	6+
09-SPBP	\$299.00 / ea	\$269.00 / ea
08-GSB1275X4	M12 x 75mm Galvanised Screw Bolt - Set of 4 \$9.90 / Set	

Plate Parking Space Protectors

- Locked up: 750(H) x 300(W)mm
- Locked flat: 35mm low
- Reflective Sign: No Parking



• No Entry signs also available - please enquire.

code	price
16-SPSP-F	\$625.00 / ea

Padlock Secured Space Protector Traditional Style

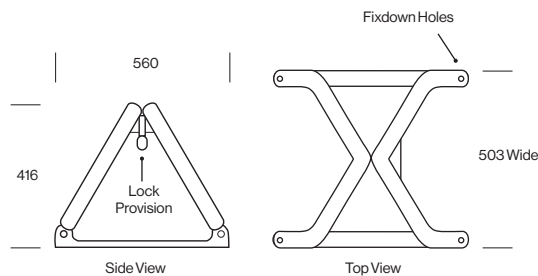

code	1-5	6-10	11+
16-SMK	\$349.00 / ea	\$319.00 / ea	\$299.00 / ea

Stainless Steel Mitred Top Bollard Features

1. 316 grade stainless steel
2. Heavy duty 10mm base plate
3. Smooth welded mitred top
4. Brushed finish
5. Heavy 3mm wall
6. Continuous post avoids base plate warping



Stainless Steel Bollards - Mitred Top - Base Plate - 140mm



Stainless Steel Bollards - Removable



Stainless Steel Bollards - Internal Base Plate

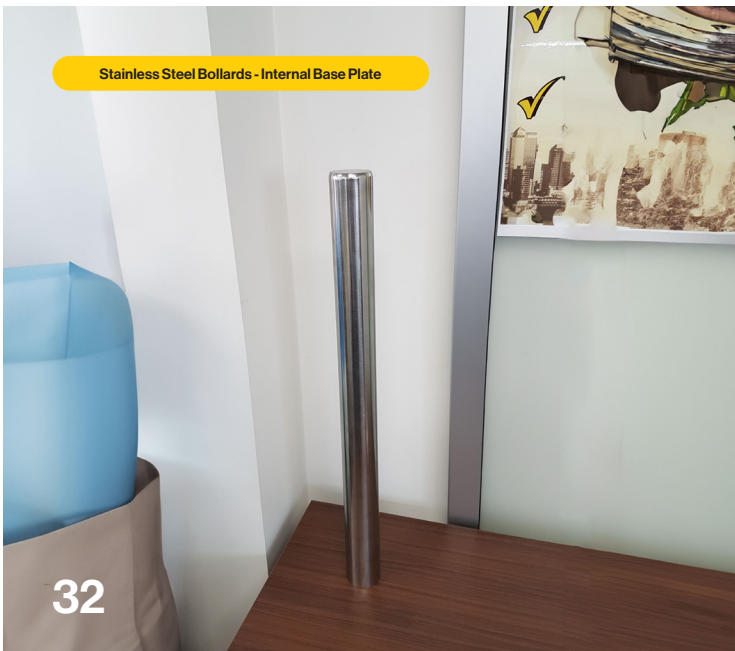

Stainless Steel Bollards - Base Plate - 90mm





Ø90

Ø140

Ø165



Ø90

Ø140

Ø165



Ø90

Ø140



Ø90

Ø140

Ø90

Stainless Steel Bollards - Base Plate

■ Heavy wall 316 marine grade stainless with #4 brush polish.



code	description	1+
08-SS90BP	Ø90 x 900 (H)mm - 9kg	\$449.00 / ea
08-SS140BP	Ø140 x 1000 (H)mm - 14kg	\$649.00 / ea
08-SS165BP	Ø165 x 1000 (H)mm - 16kg	\$799.00 / ea
08-SS220BP	Ø220 x 900mm (H)mm - 35kg	\$POA
08-GSB1275X4	M12 x 75mm Galvanised Screw Bolt - Set of 4 (Suits 90mm Bollards)	\$9.90 / set
08-GSB16100X4	M16 x 100mm Galvanised Screw Bolt - Set of 4 (Suits 140mm, 165mm Bollards)	\$23.90 / Set

Stainless Steel Bollards - In-ground

■ Heavy wall 316 marine grade stainless with #4 brush polish.



code	description	1+
08-SS90IG	Ø90 x 1100 (H)mm - 14kg	\$389.00 / ea
08-SS140IG	Ø140 x 1300 (H)mm - 22kg	\$595.00 / ea
08-SS165IG	Ø165 x 1300 (H)mm - 30kg	\$739.00 / ea
08-SS220IG	Ø220 x 1300 (H)mm - 40kg	\$POA

Stainless Steel Bollards - Mitre-Top (Base Plate)

■ Heavy wall 316 marine grade stainless with #4 brush polish.



code	description	1+
08-SS90MBP	Ø90 x 900 (H)mm - 7kg	\$469.00 / ea
08-SS140MBP	Ø140 x 1000 (H)mm - 13kg	\$679.00 / ea
08-GSB1275X4	M12 x 75mm Galvanised Screw Bolt - Set of 4 (Suits 90mm Bollards)	\$9.90 / set
08-GSB16100X4	M16 x 100mm Galvanised Screw Bolt - Set of 4 (Suits 140mm Bollards)	\$23.90 / set

Stainless Steel Bollards - Mitre-Top (In-ground)

■ Heavy wall 316 marine grade stainless with #4 brush polish.



code	description	1+
08-SS90MIG	Ø90 x 1100 (H)mm - 6.5kg	\$439.00 / ea
08-McD-SS90MIG	Ø90 x 1500 (H)mm - 8kg	\$499.00 / ea
08-SS140MIG	Ø140 x 1300 (H)mm - 14kg	\$639.00 / ea

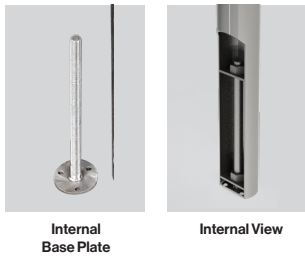

Internal Base Plate

Internal View



Ø60

Ø90

Stainless Steel Bollards Internal Base Plate

- Heavy wall 316 marine grade stainless with #4 brush polish.
- For surface mounting



code	description	1+
08-SS60IBP	Ø60 x 700(H)mm - 5kg	\$479.00 / ea
08-SS90IBP	Ø90 x 900(H)mm - 7kg	\$619.00 / ea



Ø90

Ø140

Ø165

Stainless Steel Bollards Removable

- Heavy wall 316 marine grade stainless with #4 brush polish.



code	description	1+
08-SS90R	Ø90 x 900(H)mm - 14kg	\$669.00 / ea
08-SS140R	Ø140 x 1000(H)mm - 22kg	\$995.00 / ea
08-SS165R	Ø165 x 1000(H)mm - 20kg	\$1,349.00 / ea



Ø165

Ø140

Ø90

Fixed Steel Bollards Black (Base Plate)

- Made to order - lead time applies
- Other colours available - please enquire
- Red reflective tape is supplied loose



code	description	1+
08-BL90BP	Fixed Base Plate Bollard (Round base plate) 5mm Wall - Ø90 x 900(H)mm - 10kg	\$209.90 / ea
08-BL140BP	Fixed Base Plate Bollard (Round base plate) 5mm Wall - Ø140 x 1200(H)mm - 25kg	\$319.00 / ea
09-BL165BP	Fixed Base Plate Bollard (Square base plate) 5mm Wall - Ø165 x 1200(H)mm - 30kg	\$385.00 / ea

Architectural Steel Bollards with Apollo Cap (Base Plate)

- Heavy duty galvanised steel safety bollards with polished aluminium Apollo cap
- Size: Ø165 x 1350(H)mm
- Weight: 30kg
- Red reflective tape is supplied loose



code	description	1+
09-BL165BP-A	Black powder coat	\$553.90 / ea

✓ Custom Colour Bollards also available (See Page 24-25)





The Berlin Bollard Base Plate Unslatted

- Size: 1006(H) x 155(W) x 75(D)mm
- Ø60mm Hole - can be used as a bike locking stand.
- Powder-coated colour: Dulux Black Ripple Gloss

code	description	1+
09-ABG	Plain Galvanised Bollard with Bike Locking Hole	\$555.00 / ea
09-ABB	Plain Black Bollard with Bike Locking Hole	\$615.00 / ea
08-GSB1275X4	M12 x 75mm Galvanised Screw Bolt - Set of 4	\$9.90 / Set

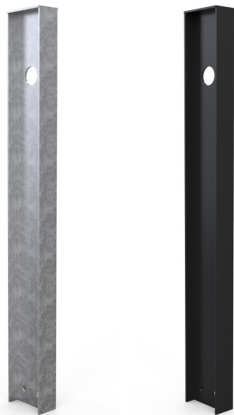

The Berlin Bollard In-ground Unslatted

- Size: 1300(H) x 155(W) x 81(D)mm (1000m above ground)
- Ø60mm Hole - can be used as a bike locking stand.
- Powder-coated colour: Dulux Black Ripple Gloss

code	description	1+
09-ABG-IG	Plain Galvanised In-ground Bollard with Bike Locking Hole	\$675.00 / ea
09-ABB-IG	Plain Black In-ground Bollard with Bike Locking Hole	\$790.00 / ea



The Berlin Bollard Removable Unslatted

- Size: 1300(H) x 155(W) x 89(D)mm (1000m above ground)
- Ø60mm Hole - can be used as a bike locking stand.
- In-ground Sleeve with Padlockable Latch
- Powder-coated colour: Dulux Black Ripple Gloss

code	description	1+
09-ABG-RE	Plain Galvanised Removable Bollard with Bike Locking Hole	\$899.00 / ea
09-ABB-RE	Plain Black Removable Bollard with Bike Locking Hole	\$995.00 / ea

Berlin Bollard Base Plate Black (Slatted) With Hole – Wood Grain Aluminium – Western Red Cedar



Berlin Bollard Base Plate Black (Slatted) With Hole Wood Grain Aluminium – Western Red Cedar



Berlin Bollard Base Plate Black (Slatted) With Hole Wood Grain Aluminium – Western Red Cedar



Berlin Bollard Base Plate Black (Slatted) With Hole Wood Grain Aluminium – Western Red Cedar



Berlin Bollard In-ground Black (Slatted) With Hole Wood Grain Aluminium – Western Red Cedar (See Page 42)





Blonde Oak

Anodised Aluminium with Hole

Merbau Hardwood

The Berlin Bollard Base Plate Black - Slatted

- Size: 1006(H) x 155(W) x 75(D)mm
- Optional Ø60mm Hole - can be used as a bike locking stand.
- Powder-coated colour: Dulux Black Ripple Gloss

code	description	1+
09-ABBS-T	Merbau Hardwood	\$825.00 / ea
09-ABBS-A	Anodised Aluminium	\$935.00 / ea
09-ABBS-C	Enviroslat Walnut	\$825.00 / ea
09-ABBS-WGA	Wood Grain Aluminium - Western Red Cedar	\$945.00 / ea
09-ABBS-BO	Wood Grain Aluminium - Blonde Oak	\$945.00 / ea
09-ABBS-T-H	Merbau Hardwood + Bike Locking or Fencing Hole	\$924.00 / ea
09-ABBS-A-H	Anodised Aluminium + Bike Locking or Fencing Hole	\$1,114.00 / ea
09-ABBS-C-H	Enviroslat Walnut + Bike Locking or Fencing Hole	\$924.00 / ea
09-ABBS-WGA-H	Wood Grain Aluminium - Western Red Cedar + Bike Locking or Fencing Hole	\$1,124.00 / ea
09-ABBS-BO-H	Wood Grain Aluminium - Blonde Oak + Bike Locking or Fencing Hole	\$1,124.00 / ea
08-GSB1275X4	M12 x 75mm Galvanised Screw Bolt - Set of 4-	\$9.90 / Set

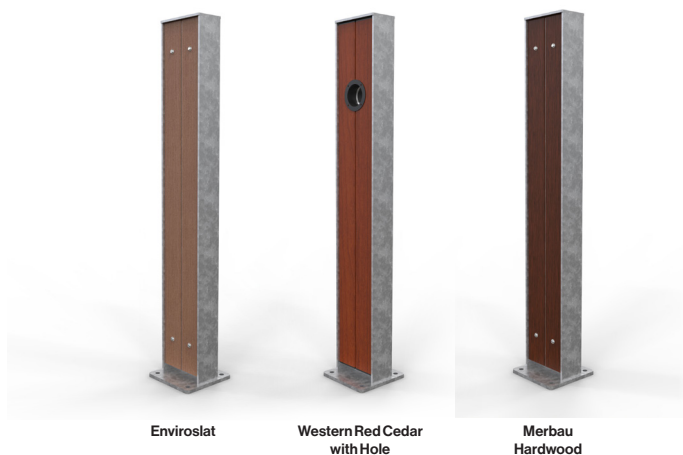

Enviroslat

Western Red Cedar with Hole

Merbau Hardwood

The Berlin Bollard Base Plate Galvanised - Slatted

- Size: 1006(H) x 155(W) x 75(D)mm
- Optional Ø60mm Hole - can be used as a bike locking stand.
- Powder-coated colour: Dulux Black Ripple Gloss

code	description	1+
09-ABGS-T	Merbau Hardwood	\$765.00 / ea
09-ABGS-A	Anodised Aluminium	\$899.00 / ea
09-ABGS-C	Enviroslat Walnut	\$765.00 / ea
09-ABGS-WGA	Wood Grain Aluminium - Western Red Cedar	\$885.00 / ea
09-ABGS-BO	Wood Grain Aluminium - Blonde Oak	\$885.00 / ea
09-ABGS-T-H	Merbau Hardwood + Bike Locking or Fencing Hole	\$864.00 / ea
09-ABGS-A-H	Anodised Aluminium + Bike Locking or Fencing Hole	\$1,054.00 / ea
09-ABGS-C-H	Enviroslat Walnut + Bike Locking or Fencing Hole	\$864.00 / ea
09-ABGS-WGA-H	Wood Grain Aluminium - Western Red Cedar + Bike Locking or Fencing Hole	\$1,064.00 / ea
09-ABGS-BO-H	Wood Grain Aluminium - Blonde Oak + Bike Locking or Fencing Hole	\$1,064.00 / ea
08-GSB1275X4	M12 x 75mm Galvanised Screw Bolt - Set of 4	\$9.90 / Set

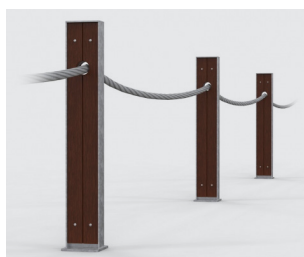



The Berlin Bollard In-ground Black - Slatted

- Size: 1300(H) x 155(W) x 81(D)mm (1000m above ground)
- Ø60mm Hole - can be used as a bike locking stand.
- Powder-coated colour: Dulux Black Ripple Gloss

code	description	1+
09-ABBS-T-IG	Merbau Hardwood	\$990.00 / ea
09-ABBS-A-IG	Anodised Aluminium	\$1,110.00 / ea
09-ABBS-C-IG	Enviroslat Walnut	\$990.00 / ea
09-ABBS-WGA-IG	Wood Grain Aluminium - Western Red Cedar	\$1,150.00 / ea
09-ABBS-BO-IG	Wood Grain Aluminium - Blonde Oak	\$1,150.00 / ea
09-ABBS-T-H-IG	Merbau Hardwood + Bike Locking or Fencing Hole	\$1,090.00 / ea
09-ABBS-A-H-IG	Anodised Aluminium + Bike Locking or Fencing Hole	\$1,299.00 / ea
09-ABBS-C-H-IG	Enviroslat Walnut + Bike Locking or Fencing Hole	\$1,090.00 / ea
09-ABBS-WGA-H-IG	Wood Grain Aluminium - Western Red Cedar + Bike Locking or Fencing Hole	\$1,330.00 / ea
09-ABBS-BO-H-IG	Wood Grain Aluminium - Blonde Oak + Bike Locking or Fencing Hole	\$1,330.00 / ea



The Berlin Bollard In-ground Galvanised - Slatted

- Size: 1300(H) x 155(W) x 81(D)mm (1000m above ground)
- Ø60mm Hole - can be used as a bike locking stand.
- Powder-coated colour: Dulux Black Ripple Gloss

code	description	1+
09-ABGS-T-IG	Merbau Hardwood	\$890.00 / ea
09-ABGS-A-IG	Anodised Aluminium	\$999.00 / ea
09-ABGS-C-IG	Enviroslat Walnut	\$890.00 / ea
09-ABGS-WGA-IG	Wood Grain Aluminium - Western Red Cedar	\$1,025.00 / ea
09-ABGS-BO-IG	Wood Grain Aluminium - Blonde Oak	\$1,025.00 / ea
09-ABGS-T-H-IG	Merbau Hardwood + Bike Locking or Fencing Hole	\$995.00 / ea
09-ABGS-A-H-IG	Anodised Aluminium + Bike Locking or Fencing Hole	\$1,180.00 / ea
09-ABGS-C-H-IG	Enviroslat Walnut + Bike Locking or Fencing Hole	\$995.00 / ea
09-ABGS-WGA-H-IG	Wood Grain Aluminium - Western Red Cedar + Bike Locking or Fencing Hole	\$1,199.00 / ea
09-ABGS-BO-H-IG	Wood Grain Aluminium - Blonde Oak + Bike Locking or Fencing Hole	\$1,199.00 / ea



Anodised Ali with Hole

Merbau Hardwood

Blonde Oak with Hole

The Berlin Bollard Removable Black - Slatted

- Size: 1300(H) x 155(W) x 89(D)mm (1000m above ground)
- Ø60mm Hole - can be used as a bike locking stand.
- In-ground Sleeve with Padlockable Latch.
- Powder-coated colour: Dulux Black Ripple Gloss

code	description	1+
09-ABBS-T-RE	Merbau Hardwood	\$1,250.00 / ea
09-ABBS-A-RE	Anodised Aluminium	\$1,360.00 / ea
09-ABBS-C-RE	Enviroslat Walnut	\$1,250.00 / ea
09-ABBS-WGA-RE	Wood Grain Aluminium - Western Red Cedar	\$1,380.00 / ea
09-ABBS-BO-RE	Wood Grain Aluminium - Blonde Oak	\$1,380.00 / ea
09-ABBS-T-H-RE	Merbau Hardwood + Bike Locking or Fencing Hole	\$1,350.00 / ea
09-ABBS-A-H-RE	Anodised Aluminium + Bike Locking or Fencing Hole	\$1,550.00 / ea
09-ABBS-C-H-RE	Enviroslat Walnut + Bike Locking or Fencing Hole	\$1,350.00 / ea
09-ABBS-WGA-H-RE	Wood Grain Aluminium - Western Red Cedar + Bike Locking or Fencing Hole	\$1,570.00 / ea
09-ABBS-BO-H-RE	Wood Grain Aluminium - Blonde Oak + Bike Locking or Fencing Hole	\$1,570.00 / ea



Blonde Oak

Enviroslat with Hole

Western Red Cedar

The Berlin Bollard Removable Galvanised - Slatted

- Size: 1300(H) x 155(W) x 89(D)mm (1000m above ground)
- Ø60mm Hole - can be used as a bike locking stand.
- In-ground Sleeve with Padlockable Latch.
- Powder-coated colour: Dulux Black Ripple Gloss

code	description	1+
09-ABGS-T-RE	Merbau Hardwood	\$1,080.00 / ea
09-ABGS-A-RE	Anodised Aluminium	\$1,190.00 / ea
09-ABGS-C-RE	Enviroslat Walnut	\$1,080.00 / ea
09-ABGS-WGA-RE	Wood Grain Aluminium - Western Red Cedar	\$1,199.00 / ea
09-ABGS-BO-RE	Wood Grain Aluminium - Blonde Oak	\$1,199.00 / ea
09-ABGS-T-H-RE	Merbau Hardwood + Bike Locking or Fencing Hole	\$1,180.00 / ea
09-ABGS-A-H-RE	Anodised Aluminium + Bike Locking or Fencing Hole	\$1,380.00 / ea
09-ABGS-C-H-RE	Enviroslat Walnut + Bike Locking or Fencing Hole	\$1,180.00 / ea
09-ABGS-WGA-H-RE	Wood Grain Aluminium - Western Red Cedar + Bike Locking or Fencing Hole	\$1,399.00 / ea
09-ABGS-BO-H-RE	Wood Grain Aluminium - Blonde Oak + Bike Locking or Fencing Hole	\$1,399.00 / ea

Concrete Sphere Bollards Features

- 1. Steel internal fixing cavity
- 2. Smooth finish sides
- 3. Reinforced concrete for strength & longevity
- 4. Doesn't crumble like sandstone
- 5. High strength 32MPa
- 6. Natural concrete white finish
- 7. Flat base for installation stability
- 8. Threaded insert lifting point

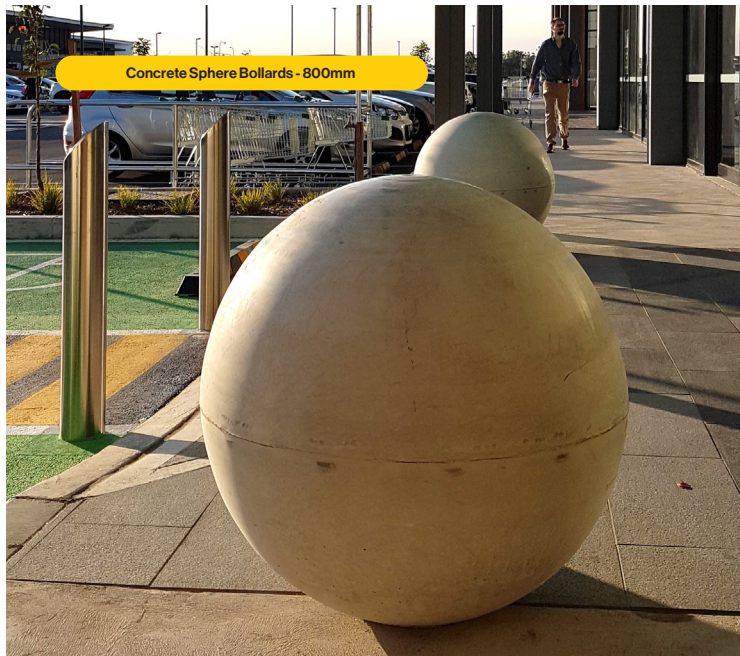
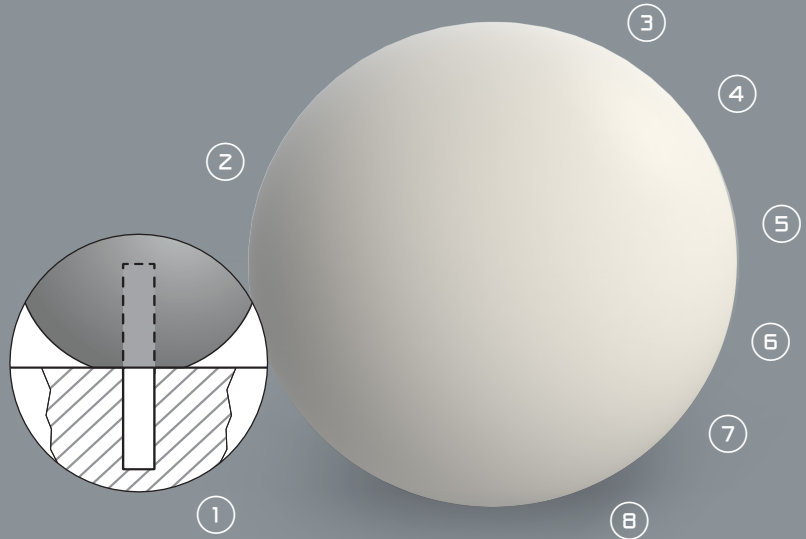

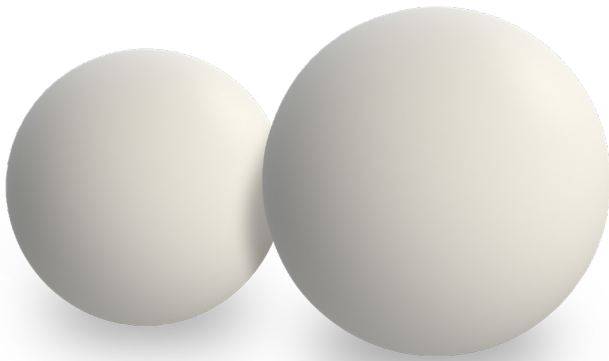

Ø600

Ø800

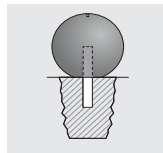

Typical Installation

Concrete Sphere Bollards

■ 600mm Size

code	description	1+
09-BCB-6	Concrete Sphere Bollard Ø600 x 560(H)mm with Ø200mm flat base - 270kg	\$1,460.00 / ea
09-BC-FC	48 x 400mm gal steel pipe ground anchor	\$19.00 / ea
07-EB12	M12 Lifting Eye Bolt	\$19.90 / ea

■ 800mm Size

code	description	1+
09-BCB-8	Concrete Sphere Bollard Ø800 x 750(H)mm with Ø250mm flat base - 640kg	\$2,390.00 / ea
09-BC-FC	48 x 520mm gal steel pipe ground anchor	\$19.00 / ea
07-EB16	M16 Lifting eye bolt	\$24.90 / ea

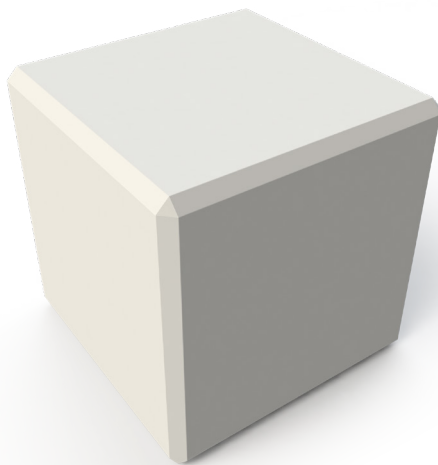

Concrete Cube Bollard

■ Size: 500(L) x 500(W) x 500(H)mm
■ Weight: 275kg

code	description	1+
09-BCC	Concrete Cube Bollard	\$1,260.00 / ea
09-BC-FC	48 x 520mm gal steel pipe ground anchor	\$19.00 / ea
07-EB12	M12 Lifting eye bolt	\$19.90 / ea

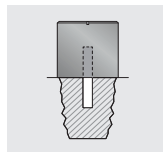

Typical Installation

Concrete Logs and Cubes



Concrete Logs & Cubes



Concrete Spheres (See Page 45)



Custom Concrete Logs



Concrete Sphere Bollards (See Page 45)



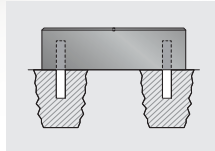
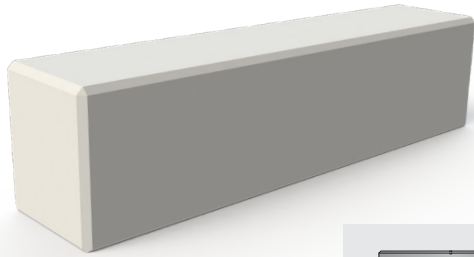

Typical Installation

Concrete Log/Bench

- Size: 1830(L) x 430(W) x 400(H)mm
- Weight: 780kg

code	description	1+
09-BCL	Concrete Log/Bench	\$2,690.00 / ea
09-BC-FC	48 x 520mm gal steel pipe (2 required)	\$19.00 / ea
07-EB12	M12 Lifting Eye Bolt (2 required)	\$19.90 / ea

✓ Custom Seating - Please enquire.

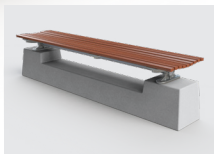
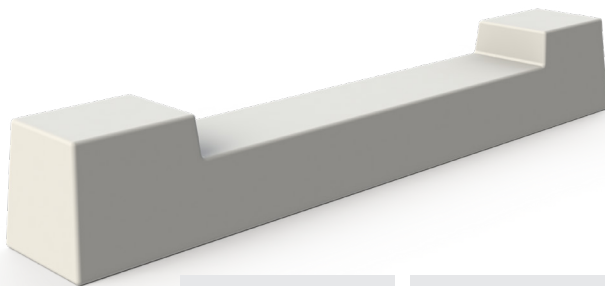

Refer to website for Plinth mounted seats

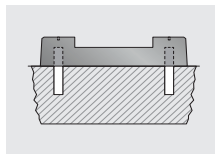

Typical Installation

Concrete Plinth

- Size: 1900(L) x 300(W) x 290(H)mm
- Weight: 400kg

code	description	1+
09-BCP	Concrete Plinth	\$1,599.00 / ea
09-BC-FC	48 x 520mm gal steel pipe (2 required)	\$19.00 / ea
07-EB12	M12 Lifting Eye Bolt (2 required)	\$19.90 / ea

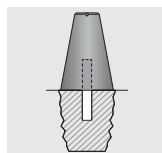
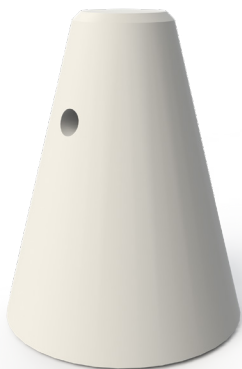

Typical Installation

Concrete Frustum Bollard

- Size: Ø600(base), Ø230(top) x 750(H)mm
- Cross Hole: Ø60 at 515mm above ground
- Weight: 250kg

code	description	1+
09-BCF	Concrete Frustum Bollard	\$1,450.00 / ea
09-BC-FC	48 x 520mm gal steel pipe ground anchor	\$19.00 / ea
07-EB12	M12 Lifting eye bolt	\$19.90 / ea

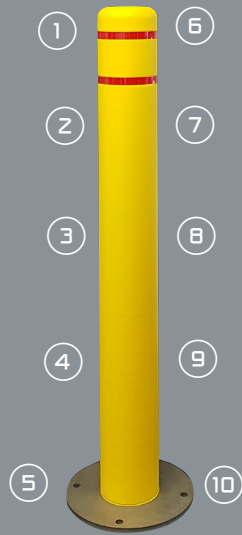

Shock Absorbing Bollards Features

1. Hot-dipped gal steel inner
2. Up to 20mm side shift movement
3. 360° degree rotation
4. Heavy 5mm wall thickness
5. Surface mount or core drill options
6. Hi-Vis reflective
7. High impact HDPE cover (no rusting or peeling)
8. Tilts up to 8 degrees and returns to vertical
9. Engineered composite materials
10. Heavy duty base plate or in-ground shaft

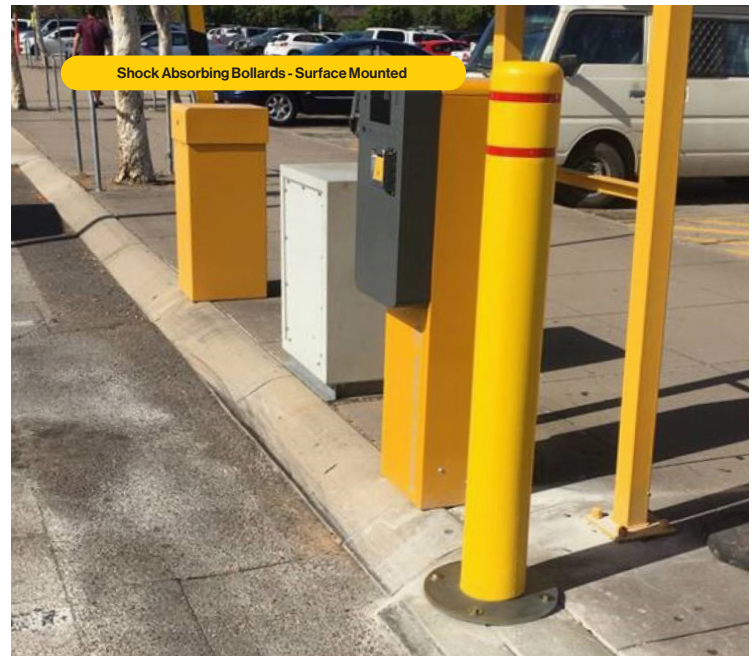



Ø90

Ø90

Ø140

Heavy Duty Plastic Impact Bollards

- 10mm wall thickness
- Flexes slightly on impact

code	description	1+
09-SP90BP-B	Ø90 x 1000 (H) - Black	\$259.00 / ea
09-SP90BP-Y	Ø90 x 1000 (H) - Yellow	\$259.00 / ea
09-SP140BP-Y	Ø140 x 1200 (H) - Yellow	\$519.00 / ea

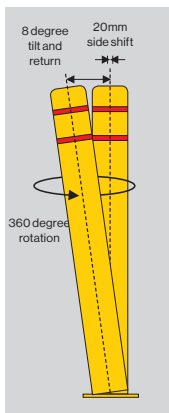

Shock Absorbing Bollards - Surface Mounted

- Engineered to tilt and return to vertical
- Bollard: Ø160 x 1330 (H)mm
- Base: Ø350mm

code		1+
09-SAB140BP		\$1,390.00 / ea
08-GSB16100X4	M16 x 100mm Galvanised Screw Bolt - Set of 4	\$23.90 / Set

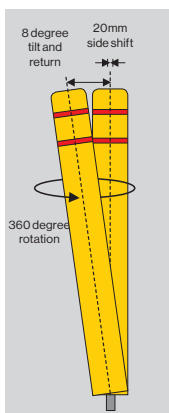

Shock Absorbing Bollards - Core Drilled

- Engineered to tilt and return to vertical
- Bollard: Ø160 x 1330 (H)mm
- In-ground shaft: Ø50mm x 300 (L)mm

code		1+
09-SAB140CD		\$998.00 / ea



One-Piece Flexible Bollards

- Durable one piece moulded robust plastic (PU)
- Rebounds after impact
- Can be completely run over

code	description	1-9	10+
15-OPF45R	Ø80x450(H)mm - Base: Ø205mm	\$59.90 / ea	\$55.90 / ea
15-OPF75	Ø80x750(H)mm - Base: Ø205mm	\$74.90 / ea	\$68.50 / ea



Lane Master Bollards

- Bollard: 100(D) x 490(H)mm
- Insert: 38(D) x 200(H)mm

code	description	1-24	25+
22-CSLMB	Lane Master Bollard	\$54.90 / ea	\$44.50 / ea
22-CSLMI	In-ground Insert	\$26.60 / ea	\$23.90 / ea

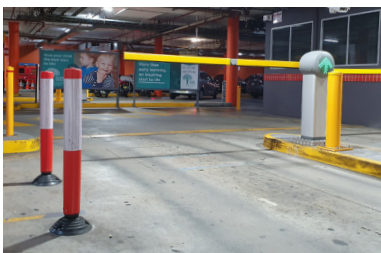

Impact Recovery Bollards

- Knock down bollards with elasticised joint
- Complete 2 piece base and post
- Post twist locks into rubber base
- Not designed to be completely run over
- Size: 1000(H)mm

Note: Reflective band pattern may vary.

code	1-9	10+
15-KDB10	\$99.50 / ea	\$88.90 / ea

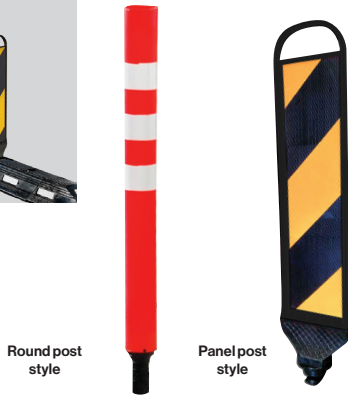
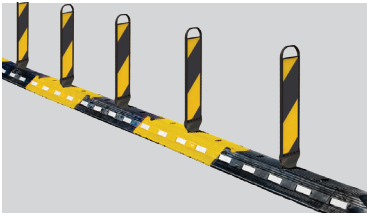

Round post style

Panel post style

Flexible Traffic Separator

- Centre module: 1000(L) x 250(W) x 80(H)mm
- End cap: 500(L) x 250(W) x 80(H)mm
- Round Post: 900(H)mm
- Panel Post: 750(H)mm

code	description	1-29	30+
03-FTS	1m Centre Modules	\$99.00 / ea	\$89.00 / ea
03-FTS-E	End Cap Set (2 modules/set)	\$119.00 / set	
03-FTS-P	Round Post (1 post required/1mtr centre module)	\$24.00 / ea	
03-FTS-PF	Panel Post - Flat (1 panel required/1mtr centre module)	\$24.00 / ea	
03-FTS-FC	Fasteners - into concrete 150mm C/Screw + Plug (x2)	\$8.00 / set	
03-FTS-FB	Fasteners - into bitumen/roadbase M12 x 300mm Gal with head (x2)	\$6.00 / set	

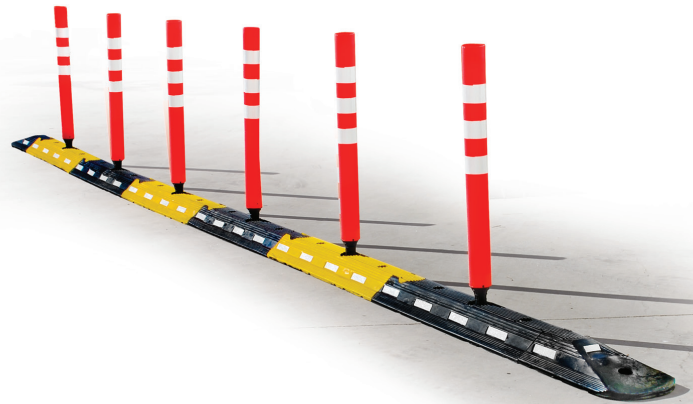

Portable Carpark Signs

See Page 179



Solid Plastic Rumble Bar

- Size: 390(L) x 205(W) x 60(H)mm
- Colour: White



code	1-19	20+
22-PRB	\$72.90 / ea	\$64.90 / ea

Plastic Line Marking Dots

- Colours: White/Yellow
- Diameter is 100mm
- Includes 125mm nail



code	colour	1-99	100-299	300+
22-LOD-Y	Yellow	\$5.99 / ea	\$5.25 / ea	\$4.50 / ea
22-LOD-W	White	\$5.99 / ea	\$5.25 / ea	\$4.50 / ea

Lane Dividers

- Base Size: 150 x 220 x 25mm
- Flap height: 285mm



code	1+
22-LANDN	\$199.00 / ea

Raised Pavement Markers

- Size: 100 x 100mm
- Colours:
 - White - Lane lines
 - Yellow - Dividing lines
 - Red - Left hand edge lines
 - Blue - Fire Hydrant locations

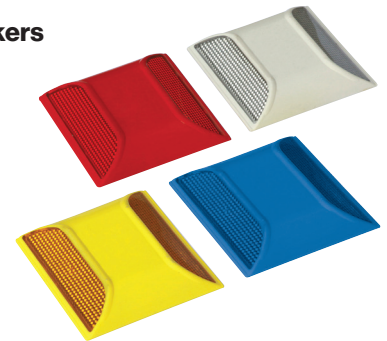

code		1-99	100+
22-RPM-W	White	\$6.50 / ea	\$4.75 / ea
22-RPM-Y	Yellow	\$6.50 / ea	\$4.75 / ea
22-RPM-R	Red	\$6.50 / ea	\$4.75 / ea
22-RPM-B	Blue	\$6.50 / ea	\$4.75 / ea

Megapoxy



code	description	1+
22-600MP	600ml Twin Pack Tubes	\$119.00 / pack
22-EPOGUN	Dispensing Gun	\$269.00 / ea
22-EPOMH	Mixing Heads	\$8.00 / ea

Corner Cube Reflectors

- Size: Ø90mm
- For vertical surfaces - not suitable for driving on.



code	colour	1-50	51+
22-CCUBE-W	White	\$6.90 / ea	\$5.80 / ea
22-CCUBE-R	Red	\$6.90 / ea	\$5.80 / ea

Aerosol Line Marking Paint

- 12 Cans per carton
- For machine application only (see line marking machine below)
- Coverage: Approximately 50lm per coat depending on surface and width of line



code	description	1-11	carton (12)
23-LMP500	(Specify colour)	\$17.50 / can	\$13.90 / can (same colour)

Road/Line Marking Paint Bulk

- Colours: White, Yellow or Blue
- Coverage: Approximately 2.5m² per litre depending on the surface



code	description	1-3	4+
23-LMP4L	4L Tin	\$149.00 / ea	\$135.00 / ea
23-LMP15L	15L Pail	\$335.00 / ea	\$288.00 / ea

Line Marking Machine

- Accurate line width adjustments
- Centre pointer
- Start/stop trigger
- Wind guard



code	1+
23-LMM	\$589.00 / ea

Instant Pothole Filler 20kg Bag

- Coverage is approximately 0.3m² at 25mm thick
- Apply in wet or dry conditions
- Cures on compaction



code	1+
22-MPR20	\$99.00 / ea

Car Park Signs

See Page 177

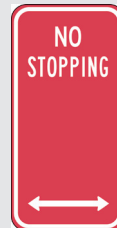

Car Park Stencil Sets Polypropylene

- Tough 1.9mm thickness
- Can be reused for many years



23-PS-PG



23-PS-NPG



23-PS-VIS



23-PS-RES

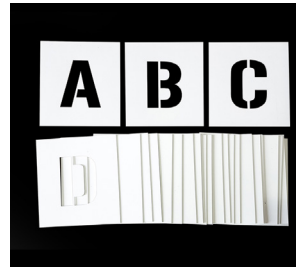

23-PSAZ (3 Sizes)



23-PS09 (3 Sizes)



23-PS-DIS-AS (800mm)



23-PS-DIS (600mm)



23-PS-PWP



23-PS-CS



23-PS-ELD

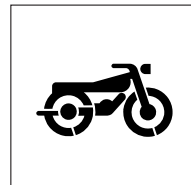

23-PS-MB

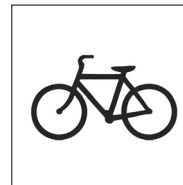

23-PS-BIC

code	description	1+
23-PS09-100	0-9Set - 100mm High	\$94.90 / set
23-PS09-200	0-9Set - 200mm High	\$125.50 / set
23-PS09-300	0-9Set - 300mm High	\$189.90 / set
23-PSAZ-100	A-ZSet - 100mm High	\$158.90 / set
23-PSAZ-200	A-ZSet - 200mm High	\$299.00 / set
23-PSAZ-300	A-ZSet - 300mm High	\$475.00 / set
23-PS-DIS	Accessible - Picto - 600mm High	\$229.00 / ea
23-PS-DIS-AS	Accessible - Picto - 800mm High	\$244.00 / ea
23-PS-BIC	Bicycle - Picto - 490(H)x800(W)mm	\$133.00 / ea

code	description	1+
23-PS-CS	Charging Station - 640mm	\$179.00 / ea
23-PS-ELD	Elderly - 640mm	\$179.00 / ea
23-PS-MB	Motorbike - 640mm	\$179.00 / ea
23-PS-NPG	No Parking - Text - 150mm High	\$199.90 / ea
23-PS-PG	Parking - Text - 150mm High	\$199.90 / ea
23-PS-PWP	Parents with Pram - 640mm High	\$179.00 / ea
23-PS-RES	Reserved - Text - 150mm High	\$199.90 / ea
23-PS-VIS	Visitor - Text - 150mm High	\$179.90 / ea

Car Park Stencil Kit Oilboard

Kit contains:

VISITOR.....	(320mm)	IN.....	(480mm)
RESERVED.....	(254mm)	OUT.....	(480mm)
NOPARKING....	(500mm)	♿.....	(600mm)
0-9	(285mm)	ARROWS.....	(1100mm)

code	1+
23-PS-KIT	\$275.00 / kit





Picto Safety Stencils Polypropylene

- 1.9mm Polypropylene
- Size: 640mm x 640mm
- Lasts for hundreds of uses
- Larger sizes available on request
- For permanent marking of safety messages on floors and walls

code	description	1+
23-PS-PICTO-(#)	(Specify item number)	\$179.90 / ea

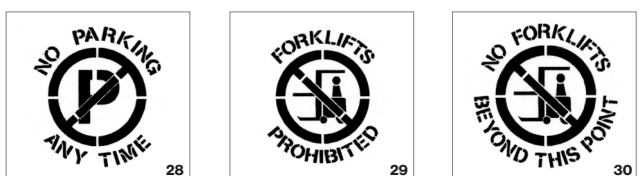

Trolley Bay Features

1. Heavy duty galvanised cast fittings
2. In-ground versions also available
3. Easily customisable
4. Trolley bay wheelstop, to stop trolleys rolling away (optional)
5. Mid rail to safely secure trolleys
6. Modular construction — easy install & repair
7. Three length configurations available: standard, half & back-to-back
8. 3 finishes available: plain galvanised, yellow, or black
9. Heavy 48mm gal pipe

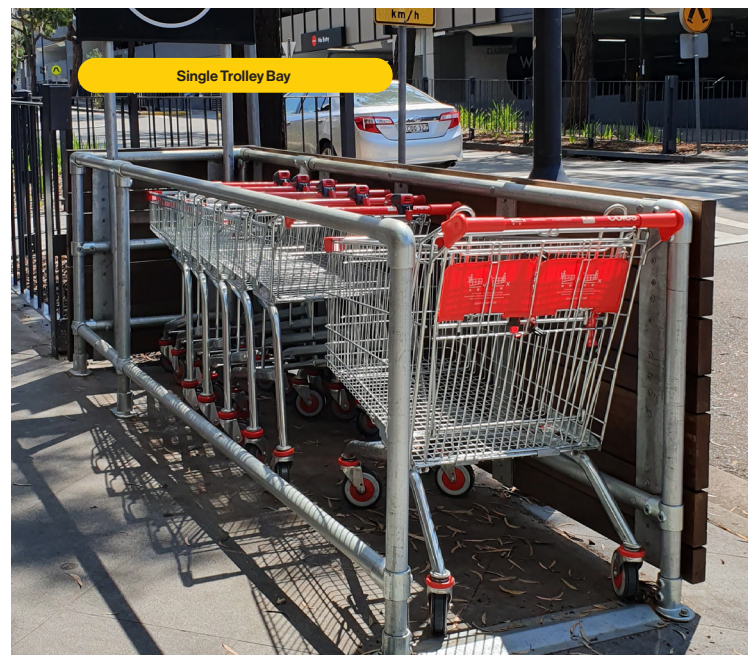
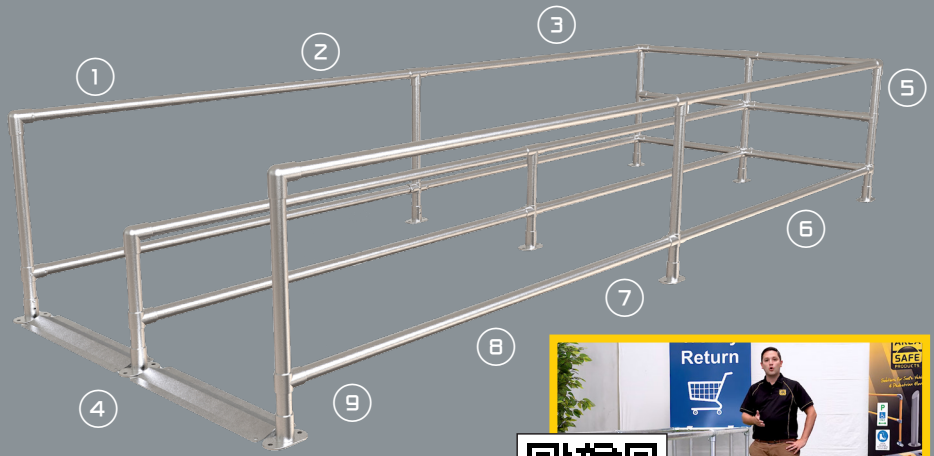



Yellow Black

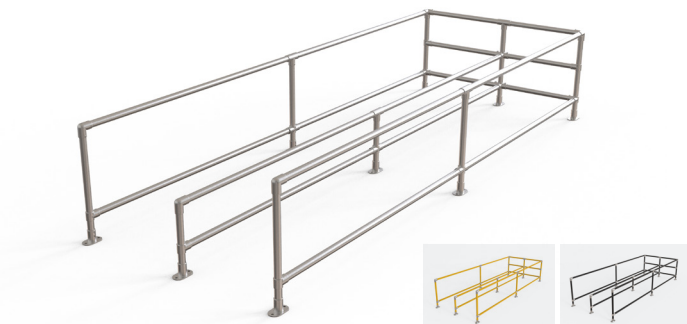

Yellow Black



Yellow Black

Trolley Bay Wheel Stop

- Retains trolleys on sloping car parks
- Size: 650(L) x 165(W) x 20(H)mm



code	1+
11-TS03	\$119.00 / ea

Trolley Bay Standard Size Single Bay

- Size: 750(W) x 4470(L) x 950(H)mm

code	finish colour	1+
11-TS10	Galvanised	\$1,360.00 / ea
11-TS10-Y	Yellow	\$1,899.00 / ea
11-TS10-B	Black	\$1,899.00 / ea
08-GSB1275X2	M12 x 75mm Galvanised Screw Bolt - Set of 2 (Requires 1 Set of Fasteners Per Base Plate)	\$4.95 / Set

✓ Note: In-ground versions also available. Add "-IG" to the end of the above codes. Pricing is the same as above prices.

Trolley Bay Standard Size Double Bay

- Size: 1500(W) x 4470(L) x 950(H)mm

code	finish colour	1+
11-TS20	Galvanised	\$1,999.00 / ea
11-TS20-Y	Yellow	\$2,940.00 / ea
11-TS20-B	Black	\$2,940.00 / ea
08-GSB1275X2	M12 x 75mm Galvanised Screw Bolt - Set of 2 (Requires 1 Set of Fasteners Per Base Plate)	\$4.95 / Set

✓ Note: In-ground versions also available. Add "-IG" to the end of the above codes. Pricing is the same as above prices.

Trolley Bay Standard Size Triple Bay

- Size: 2250(W) x 4470(L) x 950(H)mm

code	finish colour	1+
11-TS30	Galvanised	\$2,770.00 / ea
11-TS30-Y	Yellow	\$3,980.00 / ea
11-TS30-B	Black	\$3,980.00 / ea
08-GSB1275X2	M12 x 75mm Galvanised Screw Bolt - Set of 2 (Requires 1 Set of Fasteners Per Base Plate)	\$4.95 / Set

✓ Note: In-ground versions also available. Add "-IG" to the end of the above codes. Pricing is the same as above prices.

Signboard Kits

- Size: 900(W) x 1200(H) mm
- Includes frame, sign and brackets
- Custom signs can be made to order - please enquire



code	description	1+
11-TS01	Signboard Kit - Single Sided	\$645.00 / ea
11-TS02	Signboard Kit - Double Sided	\$898.00 / ea
-11-TBS	Trolley Bay Sign Only 1200x900mm	\$275.00 / ea



Galvanised



Yellow



Black



Galvanised



Yellow



Black



Galvanised



Yellow



Black

Trolley Bay Half Size Single Bay

■ Size: 750(W) x 2230(L) x 950(H)mm

code	finish colour	1+
11-THS10	Galvanised	\$930.00 / ea
11-THS10-Y	Yellow	\$1,240.00 / ea
11-THS10-B	Black	\$1,240.00 / ea
08-GSB1275X2	M12 x 75mm Galvanised Screw Bolt - Set of 2 (Requires 1 Set of Fasteners Per Base Plate)	\$4.95 / set

✓ Note: In-ground versions also available. Add "-IG" to the end of the above codes. Pricing is the same as above prices.

Trolley Bay Half Size Double Bay

■ Size: 1500(W) x 2230(L) x 950(H)mm

code	finish colour	1+
11-THS20	Galvanised	\$1,430.00 / ea
11-THS20-Y	Yellow	\$1,990.00 / ea
11-THS20-B	Black	\$1,990.00 / ea
08-GSB1275X2	M12 x 75mm Galvanised Screw Bolt - Set of 2 (Requires 1 Set of Fasteners Per Base Plate)	\$4.95 / set

✓ Note: In-ground versions also available. Add "-IG" to the end of the above codes. Pricing is the same as above prices.

Trolley Bay Half Size Triple Bay

■ Size: 2250(W) x 2230(L) x 950(H)mm

code	finish colour	1+
11-THS30	Galvanised	\$1,970.00 / ea
11-THS30-Y	Yellow	\$2,740.00 / ea
11-THS30-B	Black	\$2,740.00 / ea
08-GSB1275X2	M12 x 75mm Galvanised Screw Bolt - Set of 2 (Requires 1 Set of Fasteners Per Base Plate)	\$4.95 / set

✓ Note: In-ground versions also available. Add "-IG" to the end of the above codes. Pricing is the same as above prices.



Galvanised



Yellow



Black



Galvanised



Yellow



Black



Galvanised



Yellow



Black

Trolley Bay Back-to-Back Single Bay

■ Size: 750(W) x 8920(L) x 950(H)mm

code	finish colour	1+
11-TBBS10	Galvanised	\$2,590.00 / ea
11-TBBS10-Y	Yellow	\$3,690.00 / ea
11-TBBS10-B	Black	\$3,690.00 / ea
08-GSB1275X2	M12 x 75mm Galvanised Screw Bolt - Set of 2 (Requires 1 Set of Fasteners Per Base Plate)	\$4.95 / set

✓ Note: In-ground versions also available. Add "-IG" to the end of the above codes. Pricing is the same as above prices.

Trolley Bay Back-to-Back Double Bay

■ Size: 1500(W) x 8920(L) x 950(H)mm

code	finish colour	1+
11-TBBS20	Galvanised	\$3,890.00 / ea
11-TBBS20-Y	Yellow	\$5,699.00 / ea
11-TBBS20-B	Black	\$5,699.00 / ea
08-GSB1275X2	M12 x 75mm Galvanised Screw Bolt - Set of 2 (Requires 1 Set of Fasteners Per Base Plate)	\$4.95 / set

✓ Note: In-ground versions also available. Add "-IG" to the end of the above codes. Pricing is the same as above prices.

Trolley Bay Back-to-Back Triple Bay

■ Size: 2250(W) x 8920(L) x 950(H)mm

code	finish colour	1+
11-TBBS30	Galvanised	\$5,220.00 / ea
11-TBBS30-Y	Yellow	\$7,650.00 / ea
11-TBBS30-B	Black	\$7,650.00 / ea
08-GSB1275X2	M12 x 75mm Galvanised Screw Bolt - Set of 2 (Requires 1 Set of Fasteners Per Base Plate)	\$4.95 / set

✓ Note: In-ground versions also available. Add "-IG" to the end of the above codes. Pricing is the same as above prices.



Outdoor Convex Mirrors

- Heavy duty polycarbonate
- Brackets suit wall or post mounting

code	description	1+
18-TRAF450	450mm Mirror (60mm Post Bracket)	\$199.00 / ea
18-TRAF600	600mm Mirror (60mm Post Bracket)	\$239.00 / ea
18-TRAF800	800mm Mirror (75mm Post Bracket)	\$349.00 / ea
18-TRAF1000	1000mm Mirror (75mm Post Bracket)	\$495.00 / ea



Indoor Convex Mirrors

- Heavy duty polycarbonate
- Brackets suit wall or post mounting

code	description	1+
18-IN450D	450mm Mirror (60mm Post Bracket)	\$139.00 / ea
18-IN600D	600mm Mirror (60mm Post Bracket)	\$199.00 / ea
18-IN760D	800mm Mirror (75mm Post Bracket)	\$289.00 / ea



Stainless Steel Convex Traffic Mirrors

- Brackets included to fit 75mm posts
- Brackets suit wall or post mounting

code	description	1+
18-SS600V	600mm Stainless Steel Mirror	\$619.00 / ea
18-SS800V	800mm Stainless Steel Mirror	\$725.00 / ea
18-SS1000V	1000mm Stainless Steel Mirror	\$998.00 / ea
18-SSWMB	Wall Mount Bracket	\$85.00 / ea



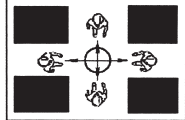

Full Dome Mirrors 360°

- Heavy duty polycarbonate
- Supplied with fixings

code	size	1+
18-DOM360-40	400mm diameter	\$275.00 / ea
18-DOM360-60	600mm diameter	\$399.00 / ea

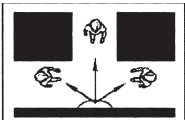

Half Dome Mirrors 180°

- Heavy duty polycarbonate
- Supplied with fixings

code	description	1+
18-DOM180-40	400mm diameter	\$249.00 / ea
18-DOM180-60	600mm diameter	\$339.00 / ea

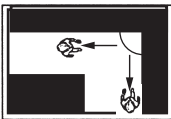

Quarter Dome Mirror 90°

- Heavy duty polycarbonate
- Supplied with fixings

code	size	1+
18-DOM90-40	400mm diameter (200mm radius)	\$159.00 / ea
18-DOM90-60	600mm diameter (300mm radius)	\$188.00 / ea



High Security Anti-Ligature Mirrors

- For Prisons and Mental Health Facilities
- Extremely robust polycarbonate dome mirrors for visual surveillance
- One-piece steel frame and a rigid foam infill
- Designed to reduce the potential for self-harm
- Unbreakable
- Improved hygiene

code	size	1+
18-DOMAL90-60	High Security Quarter-Dome Mirror 600mm - 90°	\$1,335.00 / ea
18-DOMAL180-45	High Security Half-Dome Mirror 450mm - 180°	\$1,515.00 / ea
18-DOMAL180-60	High Security Half-Dome Mirror 600mm - 180°	\$1,699.00 / ea
18-DOMAL360-45	High Security Full-Dome Mirror 450mm - 360°	\$1,620.00 / ea

Height Restriction Bar Features

1. Wind resistant
2. Reflective caution chevrons
3. Large text - easy to read
4. Galvanised chain included (1m drop)
5. End caps
6. Heavy wall 2mm RHS
7. Galvanised steel never rusts
8. Height is 100mm below lowest ceiling
9. Hi-Vis safety yellow

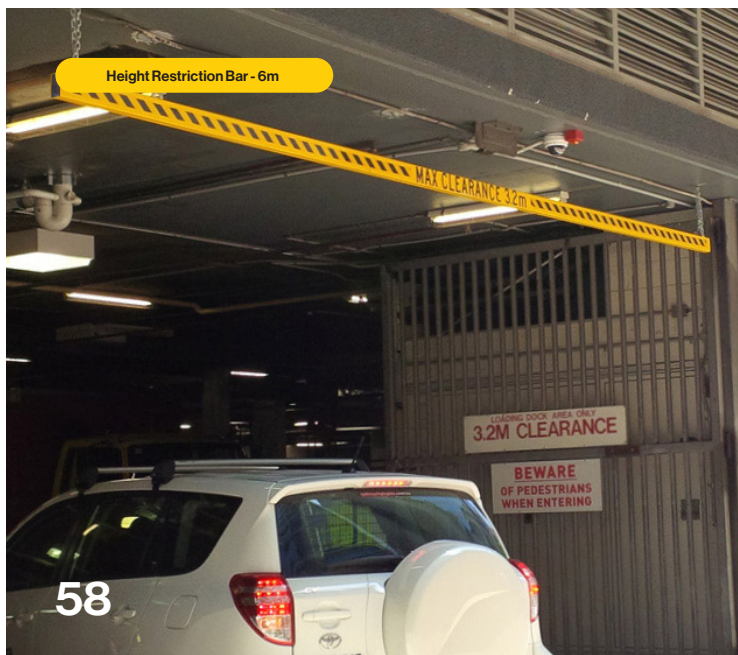
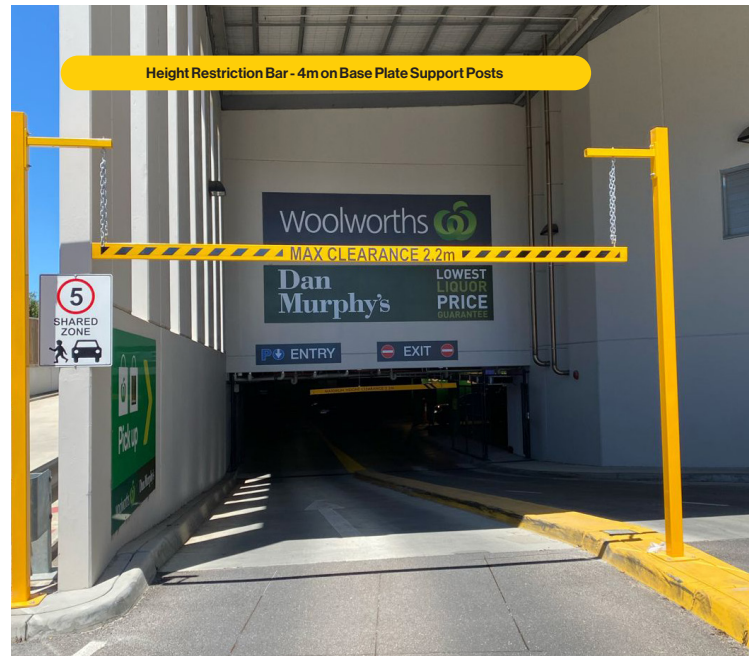
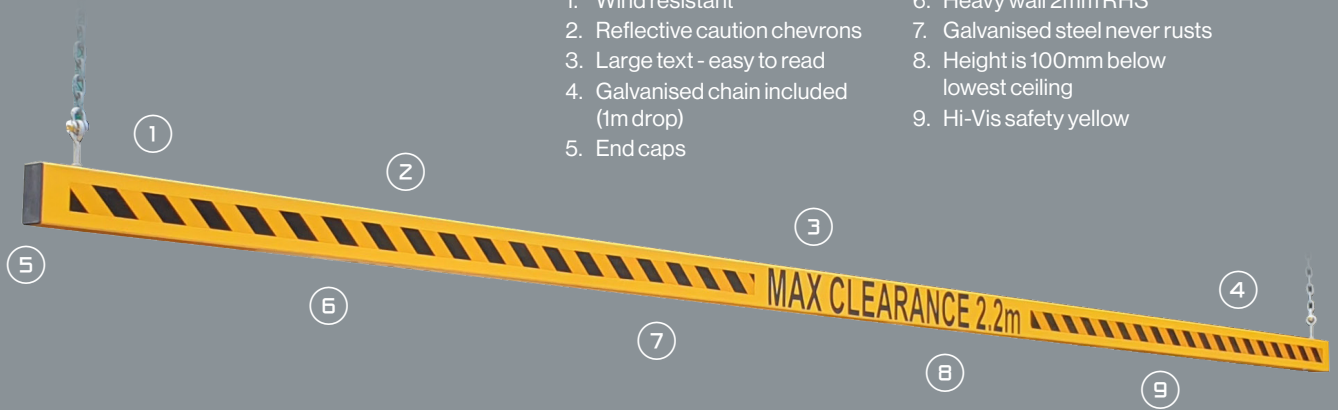



Standard 1m Height Bar Design



Standard Height Bar Design for 2m-6m sizes



Height Restriction Bars

- Height labels in stock: 1.8m, 1.9m, 2.0m, 2.1m, 2.2m, 2.3m, 2.4m
- Specify clearance height when ordering

✓ Custom height bars available - please enquire

code	description	1+
12-HRB1	Yellow Height Bar - 1m long	\$339.00 / ea
12-HRB2	Yellow Height Bar - 2m long	\$449.00 / ea
12-HRB3	Yellow Height Bar - 3m long	\$498.00 / ea
12-HRB4	Yellow Height Bar - 4m long	\$598.00 / ea
12-HRB5	Yellow Height Bar - 5m long	\$770.00 / ea
12-HRB6	Yellow Height Bar - 6m long	\$759.00 / ea

1m, 2m, 3m and 4m height bars also available in white and black.
Additional \$50/metre for black or white height bars — add to above pricing

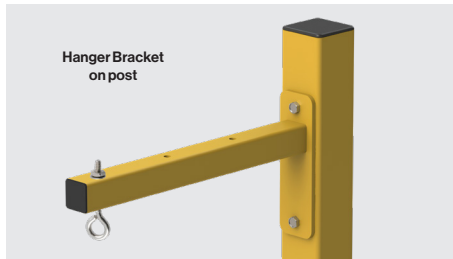

Hanger Bracket on post



Surface Mount



In-ground

Height Bar Supports

- Surface mounted post
- In-ground post
- Wall mounting bracket

code	description	1+
12-HRB-SOB	Adjustable Hanger Bracket - 500mm long & chain ring	\$175.00 / ea
12-HRB-SMP	Surface Mounted Post - 3000(H) x 89 x 89 x 4mm	\$719.00 / ea
12-HRB-IGP	In-ground Post - 4000(H) x 89 x 89 x 4mm	\$689.00 / ea
08-GSB16100X4	M16 x 100mm Galvanised Screw Bolt - Set of 4	\$23.90 / Set

Height Warning Signs

- White background with black text
- For fascias & bulkheads
- Specify clearance height when ordering
- Material: Metal

✓ Custom signs available - please enquire

code	size	1+
14-HRS212	1200(W) x 200(H)mm	\$99.00 / ea
14-HRS16	600(W) x 125(H)mm	\$69.00 / ea



14-HRS212



14-HRS16

Single Ring Bike Rail Features

1. Heavy duty 5mm base plates
2. AS2890.3 compliant
3. High quality polished finish
4. 316 grade stainless steel
5. Base plate or in-ground mounting options



Single Ring Bike Rail



Single Hoop Bike Rail - In-ground



Single Hoop Bike Rail - In-ground



Single Hoop Bike Rail - Base Plate





Single Ring Bike Rail

- 316 marine grade stainless steel
- Surface mounted: 940(L) x 800(H)mm
- In-ground: 1000(overall height) x 940(L)mm

code	description	1-9	10+
10-SRBD	Bolt Down	\$439.00 / ea	\$395.00 / ea
10-SRIG	In-ground	\$439.00 / ea	\$395.00 / ea
08-GSB1275X8	M12 x 75mm Galvanised Screw Bolt - Set of 8	\$19.80 / Set	



Single Hoop Bike Rail Stainless Steel

- 316 marine grade stainless steel
- Length: 850mm
- Height: 800mm
- *Overall height of in-ground style is 1100mm

code	description	1-9	10+
10-SSR-BD	Bolt Down	\$399.00 / ea	\$355.00 / ea
10-SSR-IG	In-ground	\$399.00 / ea	\$355.00 / ea
08-GSB1275X8	M12 x 75mm Galvanised Screw Bolt - Set of 8	\$19.80 / Set	



Single Arch Bike Rail

- Galvanised steel finish
- Length: 400mm
- Height: 800mm

code	1+
10-SABR-G	\$185.00 / ea



NEW

Single Arch Bike Rail Stainless Steel

Base plate

- 360(W) x 800(H)mm
- 150mm Round Base Plates
- 50mm Round Pipe

In-ground

- 360(W) x 1100(H)mm
- 50mm Round Base Plates

code	description	1+
10-SSSA-BP	Base plate	\$675.00 / ea
10-SSSA-IG	In-ground	\$399.00 / ea

Scooter Rack Features

1. Hot dipped galvanised
2. Single or double sided
3. Functional design
4. Holding rail
5. Large capacity 8-16 scooters
6. Cable holes for security
7. Neat scooter parking

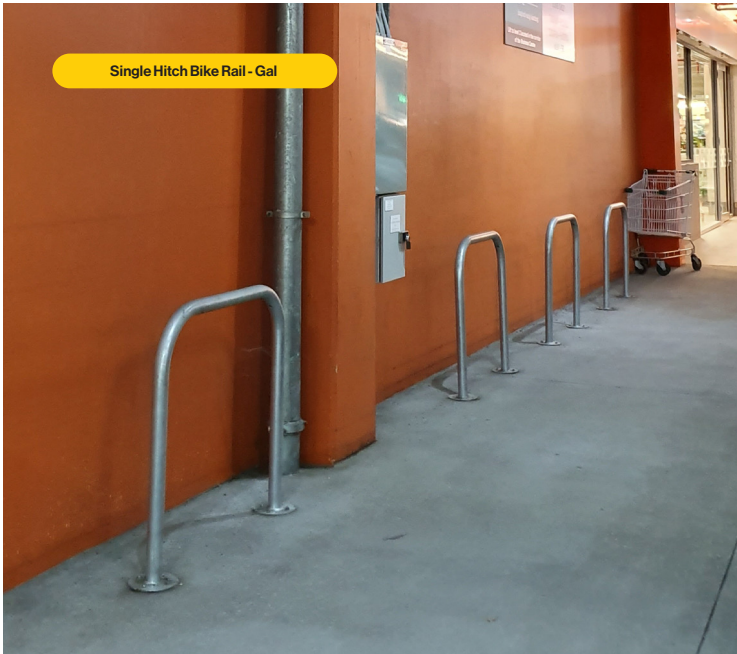



Berlin Bike Lock

- Size: 1006(H) x 155(W) x 75(D)mm
- Ø60mm Hole - can be used as a bike locking.

code	description	1+
09-ABGS-WGA-H	Wood Grain Aluminium - Western Red Cedar	\$1064.00 / ea
09-ABG	Plain Galvanised Bollard with Bike Locking Hole	\$555.00 / ea
09-ABB	Plain Black Bollard with Bike Locking Hole	\$615.00 / ea

✓ See our full range of Berlin Bollards on Pages 40-43

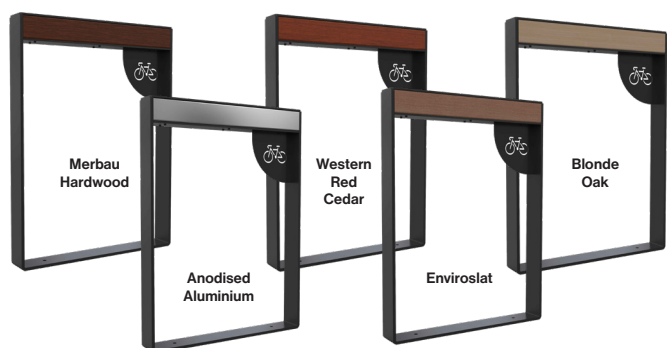

Milan Bike Rack

- Size: 600(W) x 80(D) x 800(H)mm
- Colour: Monument Satin

code	description	1+
10-AMBR-T	Merbau Hardwood	\$760.00 / ea
10-AMBR-A	Anodised Aluminium	\$795.00 / ea
10-AMBR-C	Enviroslat Composite	\$835.00 / ea
10-AMBR-WRC	Wood Grain Aluminium Western Red Cedar	\$835.00 / ea
10-AMBR-BO	Wood Grain Aluminium Blonde Oak	\$835.00 / ea



Single Hitch Bike Rail Galvanised Steel

- Length: 850mm
- Height: 800mm

code	description	1+
10-SHBIKE-G	Galvanised finish	\$195.00 / ea
10-SHBIKE	Powder Coated Black	\$265.00 / ea
10-SHBIKE-Y	Powder Coated Safety Yellow	\$265.00 / ea



Scooter Racks

Singled Sided

- Parking for up to 6-8 scooters
- Suitable for e-scooters
- Length: 850mm
- Height: 800mm
- Width: 287mm

Double Sided

- Parking for up to 12-16 scooters
- Suitable for e-scooters
- Length: 850mm
- Height: 800mm
- Width: 464mm

code	description	1+
10-SCOOT-S	Single Sided	\$439.00 / ea
10-SCOOT-D	Double sided	\$479.00 / ea

Compact P4 Bike Rack Features

1. Varying height wheel supports to stop bikes hitting each other
2. Open ends for continuous line installation
3. Modular construction for easy assembly
4. Concealed fixings for extra security
5. Hot dip galvanised
6. Heavy duty rubber for extra protection (optional)

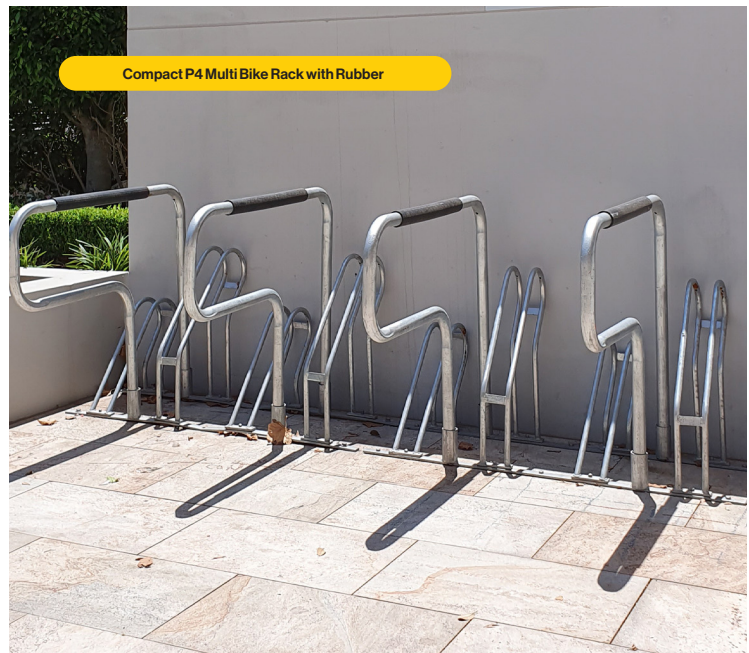
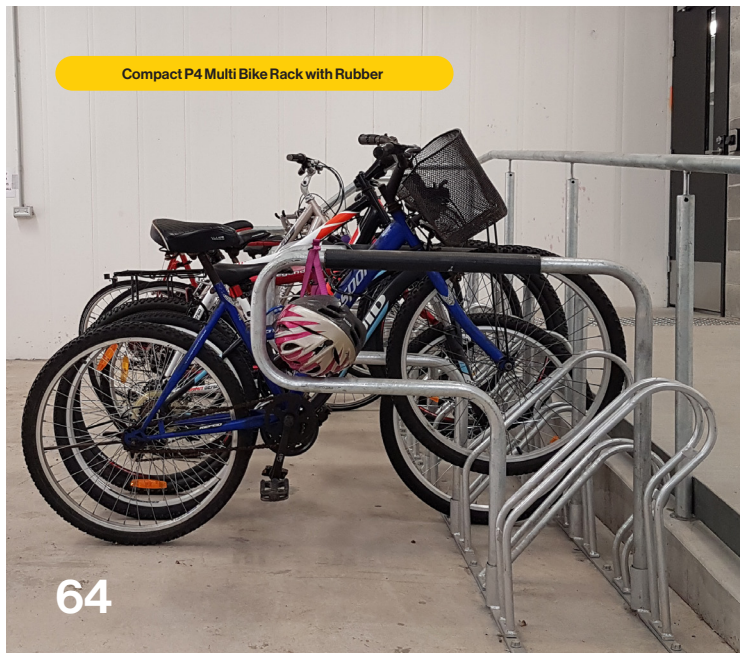
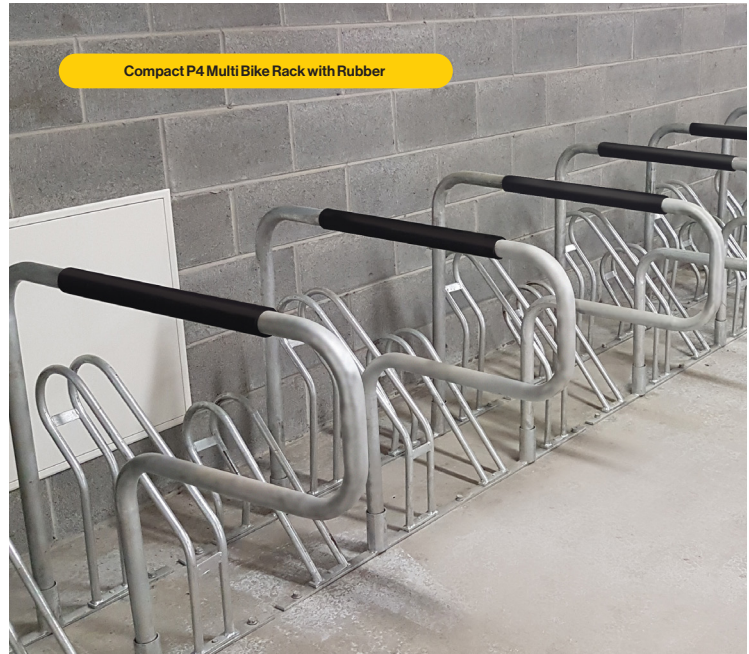
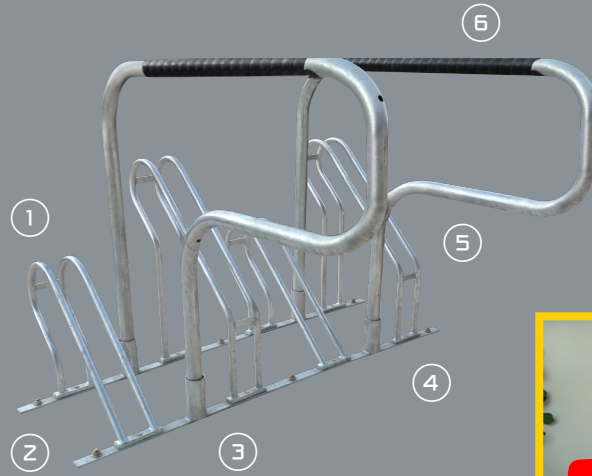



Compact P4 Multi Bike Rack

- Size: 1200(L) x 830(H) x 1060(D)mm
- Can also be installed on 30° angle
- Wheel gap is 60mm

code	description	1+
10-CP4	Bike rack (no rubber)	\$469.00/ ea
10-CP4-R	Optional rubber (as shown)	\$149.00/ ea



Compact P2 Multi Bike Rack

- Size: 600(L) x 830(H) x 1060(D)mm
- Wheel gap is 60mm

code	description	1+
10-CP2	Bike rack (no rubber)	\$339.00/ ea
10-CP2-R	Optional rubber (as shown)	\$75.00/ ea



Micro Bike Rack

- Size: 470(L) x 345(H) x 110(W)mm
- Wheel gap is 60mm

code	1+
10-MBR	\$129.00/ ea

Bike Storage Shelters

See online



Coat Hanger Bike Rack Features

1. Meets Class 2 or 3 security level
2. Fixing points
3. Heavy wall tube frame
4. Heavy duty 'hangers' for safely securing bike
5. Galvanised or stainless steel finish
6. Drain holes inside bend

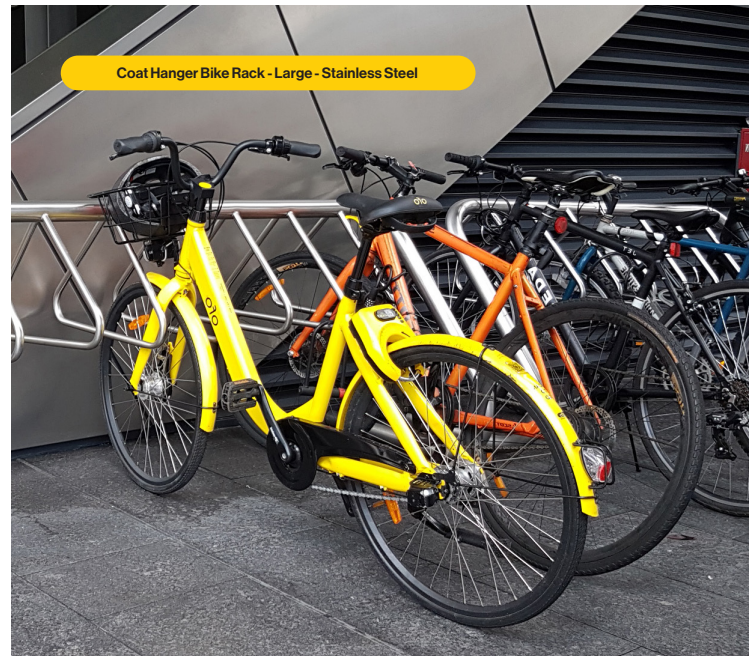
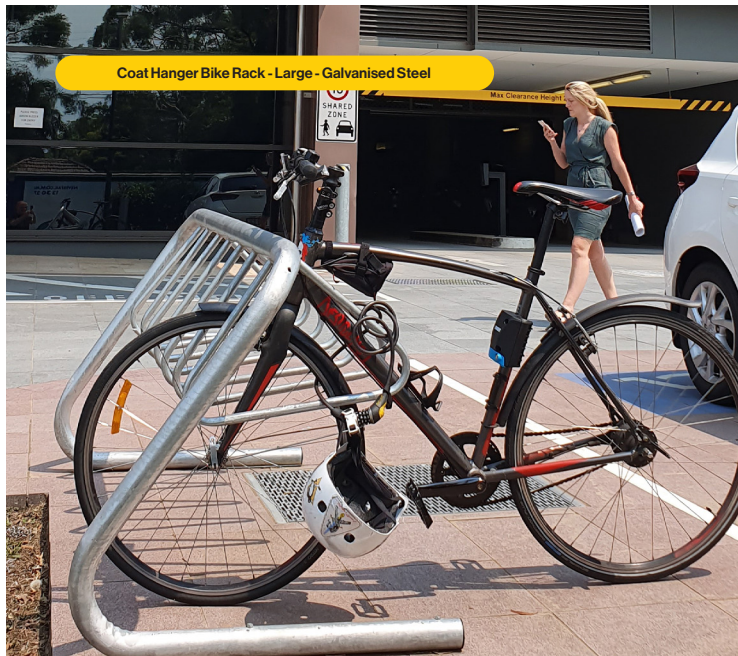
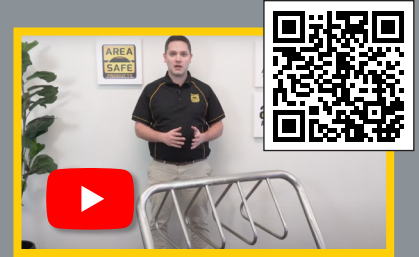



Small Coat Hanger Bike Rack

- Capacity: Up to 5 bikes
- Size: 800(L) x 850(W) x 850(H)mm
- Weight: 21kg

code	description	1+
10-CHS-G	Galvanised finish	\$739.00 / ea
10-CHS-SS	Stainless steel	\$1,165.00 / ea



Medium Coat Hanger Bike Rack

- Capacity: Up to 7 bikes
- Size: 1250(L) x 850(H) x 850(W)mm
- Weight: 30kg

code	description	1+
10-CHM-G	Galvanised finish	\$939.00 / ea
10-CHM-SS	Stainless steel	\$1,289.00 / ea



Large Coat Hanger Bike Rack

- Capacity: Up to 10 bikes
- Size: 1900(L) x 850(W) x 850(H)mm
- Weight: 47kg

code	description	1+
10-CHL-G	Galvanised finish	\$1,199.00 / ea
10-CHL-SS	Stainless steel	\$1,995.00 / ea

5 Bike Rack Features

1. Heavy duty steel frame
2. Can be bolted down, can be attached to a wall, or can be joined back to back
3. Modular for easy assembly
4. High quality black gloss finish

Find out ways bike parking facilities will benefit your business

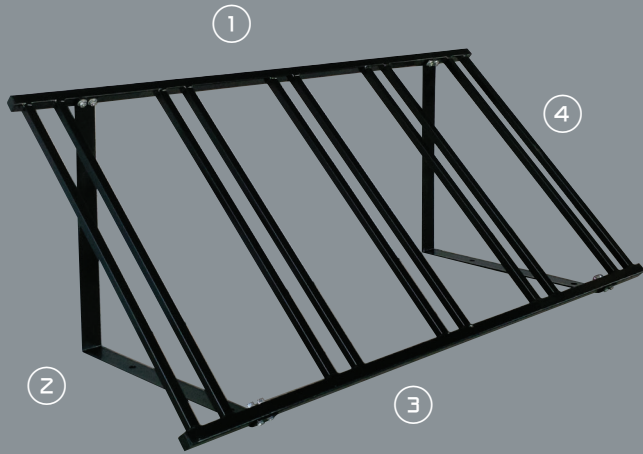

5 Bike Rack



Multi Bike Station



6 Bike Low Profile Rack



6 Bike Low Profile Rack



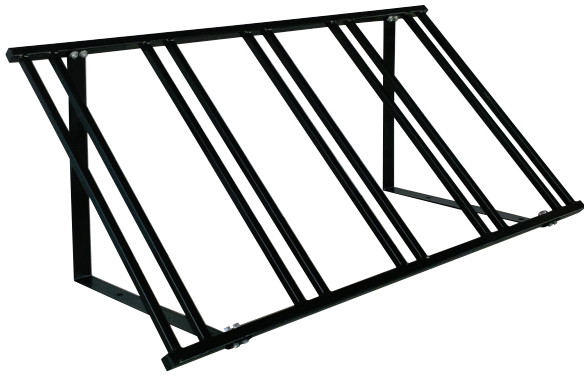

5 Bike Rack

- Powder coated gloss black
- Size: 1400(L) x 600(W) x 600(H)mm
- Wheel gap is 56mm
- Weight: 15kg

code	1+
10-5BIKE	\$465.00 / ea

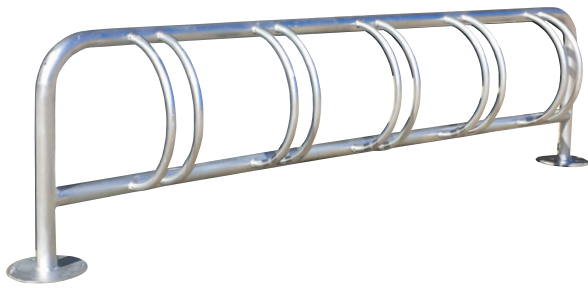

Multi Bike Station

- Galvanised steel finish
- Size: 2400(L) x 250(W) x 600(H)mm
- Wheel gap is 58mm
- Weight: 35kg

code	1+
10-MBS	\$749.00 / ea



4 Bike Low Profile Bike Rack

- Galvanised steel finish
- Size: 1500(L) x 440(W) x 270(H)mm
- Wheel gap is 70mm
- Weight: 14kg

code	1+
10-4BLP	\$449.00 / ea



6 Bike Low Profile Bike Rack

- Galvanised steel finish
- Size: 2415(L) x 440(W) x 270(H)mm
- Wheel gap is 70mm
- Weight: 24kg

code	1+
10-6BLP	\$555.00 / ea

Buffalo Bike Rack Features

1. Utilise over-bonnet car park wall space
2. Upturn prevents bikes from accidental dislodgement
3. Attractive black gloss finish
4. Safe rounded corners
5. Wire rack for hanging gloves, helmets and small accessories
6. Self-adhesive closed-cell foam padding prevents scratching the bike frame
7. 4 holes for secure wall mounting
8. Loop frame helps store recreation accessories
9. Meets AS28903 for Class 2 or 3 Security level



Floor Mounted Hanging Bike Rack



Wall Mounted Hanging Bike Rack - Double

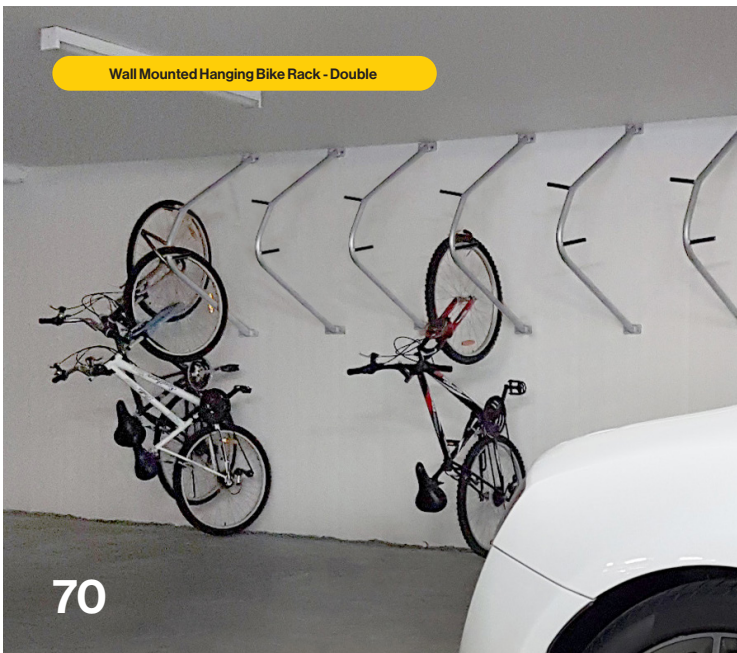

Wall Mounted Hanging Bike Rack - Single

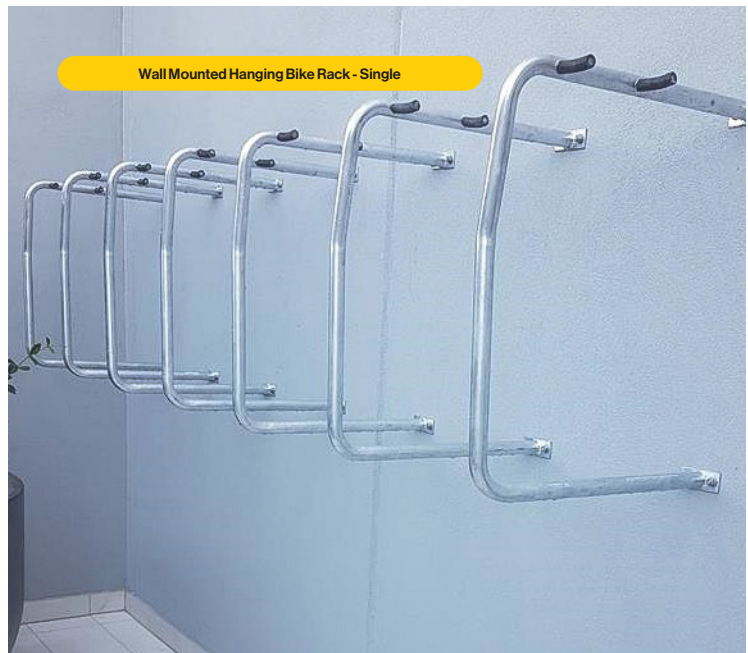



Buffalo Bike Rack

- Size: 350(W) x 450(H) x 600(D)mm
- Weight: 4.5kg
- Includes foam rubber protectors

code	1-9	10+
10-BBR	\$159.00/ea	\$145.00/ea

Wall Mounted Hanging Bike Rack Single

- Size: 750(H) x 600(D) x 200(W)mm
- Weight: 3.5kg
- Includes rubber protectors

code	1-9	10+
10-SWMBR	\$155.00/ea	\$125.00/ea

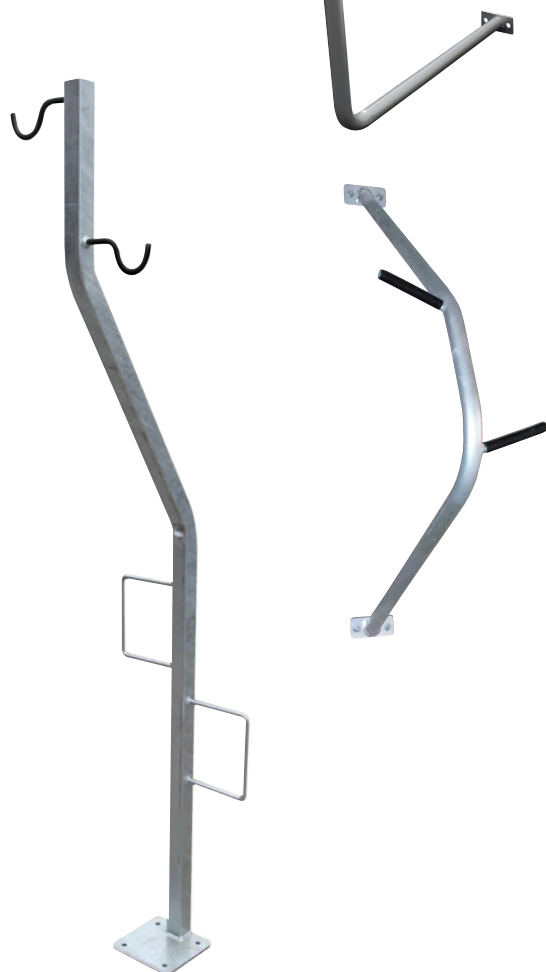

Wall Mounted Hanging Bike Rack Double

- Capacity: 2 bikes
- Size: 1100(H) x 720(D) x 276(W)mm
- Weight: 4kg
- Includes rubber protectors

code	1-9	10+
10-WMBR	\$219.00/ea	\$189.00/ea

Floor Mounted Hanging Bike Rack Double

- Size: 2150 (H) x 430(W) x 480(D)mm
- Weight: 12kg
- Includes rubber protectors

code	1-9	10+
10-SMHBR	\$399.00/ea	\$365.00/ea
08-GSB1275X4	M12x75mm Galvanised Screw Bolt - Set of 4 \$9.90/Set	

Other Area Safe Categories



Industrial Safety



Signage & Safety

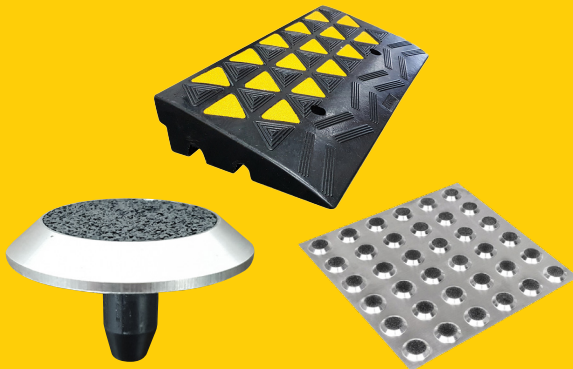

Matting Ramps & Tactiles

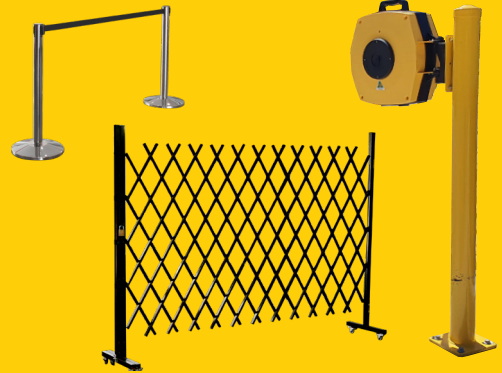

Pedestrian Barriers



www.areasafe.com.au



Email: sales@areasafe.com.au

Mail: PO Box 82, Plumpton NSW 2761

Address: 17 Sterling Road, Minchinbury NSW 2770

Hours: Open from 7:00am - 5:00pm, Monday to Friday