

Area Safe Products Industrial Safety Catalogue 2024

39



→ Customer Focused

→ Speedy Service

→ Innovative products



Industrial Safety Edition
October - December
Spring 2024

phone 1300 889 821

Web www.areasafe.com.au

Email sales@areasafe.com.au



Why Choose Area Safe Products?

Customer Focused



Speedy Service



Innovative Designs



All prices advertised through this catalogue exclude 10% GST. Design & prices subject to change without notice. E&OE © 2024 Area Safe Products Pty Ltd.

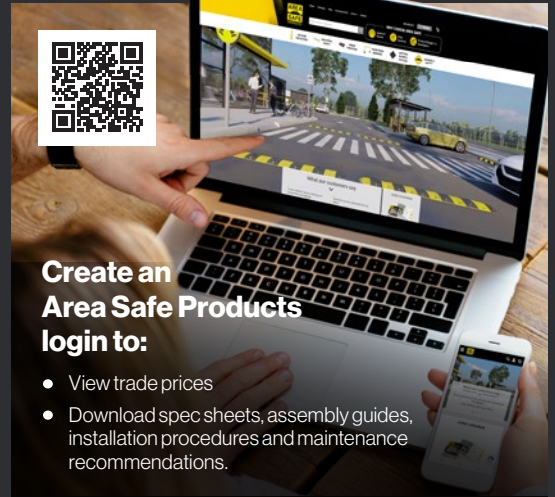

Create an Area Safe Products login to:

- View trade prices
- Download spec sheets, assembly guides, installation procedures and maintenance recommendations.

Contact us

Email: sales@areasafe.com.au
Web: www.areasafe.com.au
Mail: PO Box 82, Plumpton NSW 2761
Address: 17 Sterling Road, Minchinbury, NSW 2770
Open: 7:00am - 5:00pm, Monday-Friday
ABN: 74 114 414 185

phone:
1300 889 821

The Area Safe Group



Contents **Industrial Safety**

AREA SAFE PRODUCTS

NOVEMBER 2024

TRADE CATALOGUE #39

Surex Pedestrian Rail Kits	3
Modular Fencing	7
Surex Gates and Barriers	8
W-Beam Guard Rails	11
Driver Safe Zone Kits	14
U-Bollards	15
Swing and Boom Gates	16
Loading Dock Stairs	23
Machine Guarding	24
Downpipe Guards	26
Surex Low Recessed Rails	27
Steel Truck Loading Dock Reversing Guides	28
Corner Guards	29
Rubber Guards	30
Rubber Protectors	31



Surex Pedestrian Rail Kits Safety Yellow

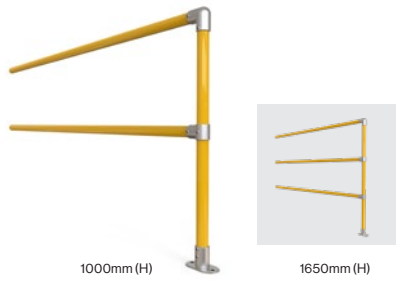

End Section Kit

- Includes: 1 x End Post, 2 x Rails (3x Rails for 1650mm)
- Post: Ø48 x 950mm (overall height 1000mm) / Ø48 x 1600 (Overall Height 1650mm)



code	overall size	1+
11-MHRE	1000(H)mm x 2200(L)mm - 2 rails	\$319.00 / set
11-MHRE-165	1650(H)mm x 2200(L)mm - 3 rails	\$499.00 / set

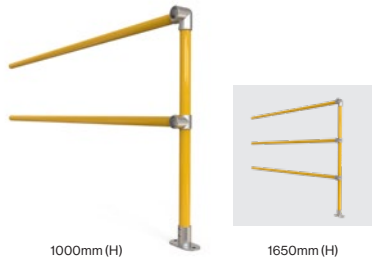

Corner Section Kit

- Includes: 1 x Corner Post, 2 x Rails (3x Rails for 1650mm)
- Rails: Ø48 x 2160(L)mm
- Post: Ø48 x 950mm (overall height 1000mm) / Ø48 x 1600 (Overall Height 1650mm)



code	overall size	1+
11-MHRC	1000(H)mm x 2200(L)mm - 2 rails	\$319.00 / set
11-MHRC-165	1650(H)mm x 2200(L)mm - 3 rails	\$499.00 / set

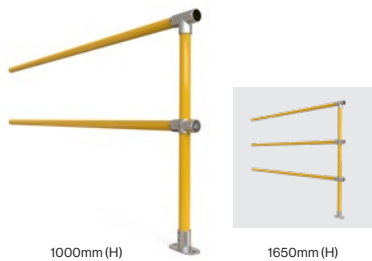

Mid Section Kit

- Includes: 1 x Intermediate Post, 2 x Rails (3x Rails for 1650mm)
- Rails: Ø48 x 2160(L)mm
- Post: Ø48 x 950mm (overall height 1000mm) / Ø48 x 1600 (Overall Height 1650mm)



code	overall size	1+
11-MHRM	1000(H)mm x 2200(L)mm - 2 rails	\$319.00 / set
11-MHRM-165	1650(H)mm x 2200(L)mm - 3 rails	\$499.00 / set

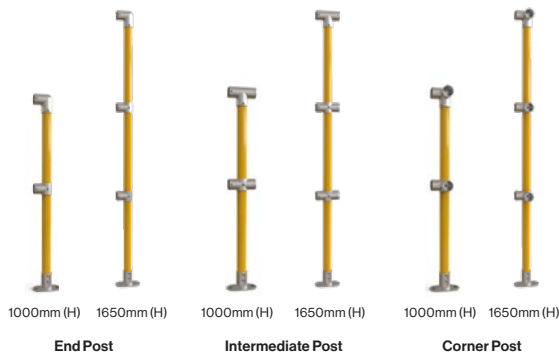

Post, Rail and Fastener Kits

- Includes post and fittings
- Post: Ø48 x 950mm (overall height 1000mm) / Ø48 x 1600 (Overall Height 1650mm)



code	description	overall height	1+
11-MHR-PE	End Post with fittings	1000mm	\$165.00 / set
11-MHR-PE-165	End Post with fittings	1650mm	\$245.00 / set
11-MHR-PM	Intermediate Post with fittings	1000mm	\$165.00 / set
11-MHR-PM-165	Intermediate Post with fittings	1650mm	\$245.00 / set
11-MHR-PC	Corner Post with fittings	1000mm	\$165.00 / set
11-MHR-PC-165	Corner Post with fittings	1650mm	\$245.00 / set
11-MH-PCRAIL	Horizontal Rail (ø48mm x 2160mm Yellow)		\$115.00 / ea
08-GSB1275X2	M12 x 75mm Galvanised Screw Bolt - Set of 2 (Requires 1 Set of Fasteners Per Base Plate)		\$4.95 / Set

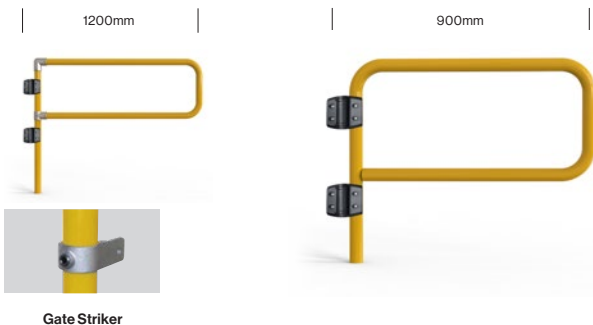

Self-Closing Gate Kits - Safety Yellow

- 900mm wide - Fixed width
- 1200mm wide - Adjustable - Can be cut to size on site.



code	description	1+
11-MHRG-900	Self Closing Gate - 900mm	\$449.00 / ea
11-MHRG-1200	Self Closing Gate - 1200mm	\$549.00 / set
-199D48	Gate Striker	\$23.90 / ea

Modular Pedestrian Rail - Yellow



Modular Pedestrian Rail - Yellow



Modular Pedestrian Rail - Galvanised

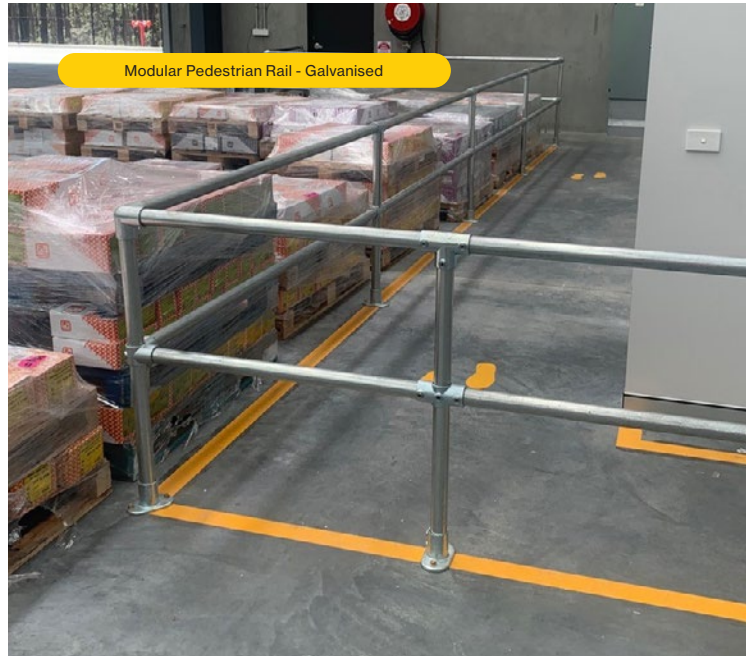

Modular Pedestrian Rail - Yellow



Modular Pedestrian Rail - Yellow



Surex Pedestrian Rail Kits Galvanised



End Section Kit

- Includes: 1 x End Post, 2 x Rails (3x Rails for 1650mm)
- Rails: Ø48 x 2160(L)mm
- Post: Ø48 x 950mm (overall height 1000mm) / Ø48 x 1600 (Overall Height 1650mm)

code	overall size	1+
11-MHRE-G	1000(H)mm x 2200(L)mm - 2 Rails	\$229.00 / set
11-MHRE-G-165	1650mm x 2200(L)mm - 3 rails	\$369.00 / set



Corner Section Kit

- Includes: 1x Corner post, 2 Rails (3x Rails for 1650mm)
- Rails: Ø48 x 2160(L)mm
- Post: Ø48 x 950mm (overall height 1000mm) / Ø48 x 1600 (overall height 1650mm)

code	overall size	1+
11-MHRC-G	1000(H)mm x 2200(L)mm - 2 rails	\$229.00 / set
11-MHRC-G-165	1650mm x 2200(L)mm - 3 rails	\$339.00 / set



Mid Section Kit

- Includes: 1 x Intermediate Post, 2 x Rails (3x Rails for 1650mm)
- Rails: Ø48 x 2160(L)mm
- Post: Ø48 x 950mm (overall height 1000mm) / Ø48 x 1600 (overall height 1650mm)

code	overall size	1+
11-MHRM-G	1000(H)mm x 2200(L)mm	\$229.00 / set
11-MHRM-G-165	1650mm x 2200(L)mm - 3 rails	\$369.00 / set



Post, Rail and Fastener Kits

- Includes post and fittings
- Size: Ø48 x 1000mm (overall) / Ø48 x 1600 (Overall 1650mm)

code	description	overall height	1+
11-MHR-PE-G	End Post with fittings	1000mm	\$139.00 / set
11-MHR-PE-G-165	End Post with fittings	1650mm	\$215.00 / set
11-MHR-PM-G	Intermediate Post with fittings	1000mm	\$139.00 / set
11-MHR-PM-G-165	Intermediate Post with fittings	1650mm	\$215.00 / set
11-MHR-PC-G	Corner Post with fittings	1000mm	\$139.00 / set
11-MHR-PC-G-165	Corner Post with fittings	1650mm	\$215.00 / set
STEEL40NBx2160	Horizontal Rail (ø48mm x 2160mm Galvanised)		\$79.90 / ea
08-GSB1275X2	M12 x 75mm Galvanised Screw Bolt - Set of 2 (Requires 1 Set of Fasteners Per Base Plate)		\$4.95 / Set

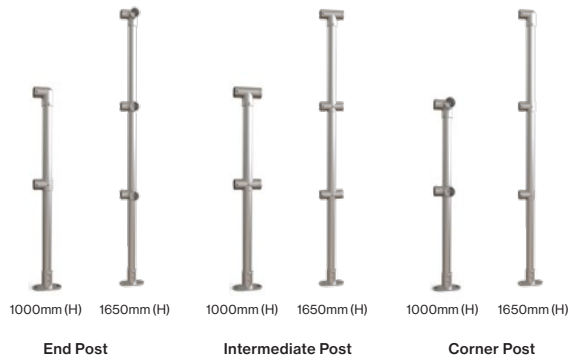

1000mm (H) 1650mm (H) 1000mm (H) 1650mm (H) 1000mm (H) 1650mm (H)

End Post Intermediate Post Corner Post

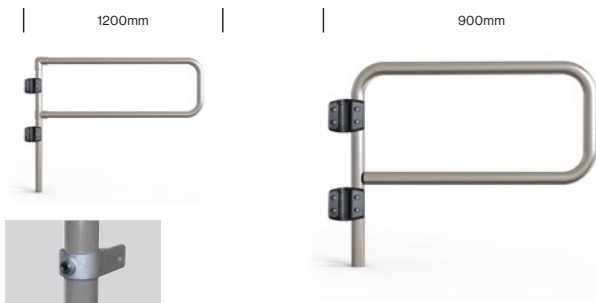

Gate Striker

Self-Closing Gate Kits - Galvanised

- 900mm wide - Fixed width
- 1200mm wide - Adjustable - Can be cut to size on site

code	description	1+
11-MHRG-G-900	Self Closing Gate - 900mm	\$399.00 / set
11-MHRG-G-1200	Self Closing Gate - 1200mm	\$499.00 / set
-199D48	Gate Striker	\$23.90 / ea



Surex Pedestrian 'Tall-Rail' Kits Safety Yellow

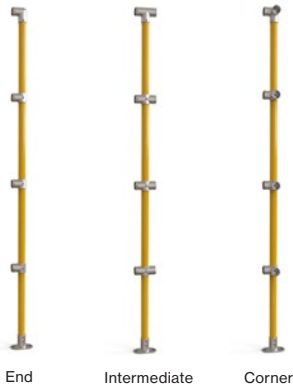

NEW

End Section Kit 'Tall-Rail'

- Includes: 1x End Post, 4 x Rails
- Rails: Ø48 x 2160(L)mm (overall length 2200mm)
- Post: Ø48 x 2160mm (overall height 2200mm)



code	overall size	1+
11-MTRE	2200(H) x 2200(L)mm - 4 Rails	\$649.00 / set

NEW

Corner Section Kit 'Tall-Rail'

- Includes: 1x Corner post, 4 x Rails
- Rails: Ø48 x 2160(L)mm (overall length 2200mm)
- Post: Ø48 x 2160mm (overall height 2200mm)



code	overall size	1+
11-MTRC	2200(H) x 2200(L)mm - 4 Rails	\$649.00 / set

NEW

Mid Section Kit 'Tall-Rail'

- Includes: 1x Intermediate post, 4 x Rails
- Rails: Ø48 x 2160(L)mm (overall length 2200mm)
- Post: Ø48 x 2160mm (overall height 2200mm)



code	overall size	1+
11-MTRM	2200(H) x 2200(L)mm - 4 Rails	\$649.00 / set

NEW

Post, Rail, Brace & Fastener Kits 'Tall Rail'

- Includes post and fittings
- Size: Ø48 x 2200mm (overall)



code	description	1+
11-MTR-PE	Yellow End Post with fittings	\$285.00 / set
11-MTR-PM	Yellow Intermediate Post with fittings	\$285.00 / set
11-MTR-PC	Yellow Corner Post with fittings	\$285.00 / set
11-MH-PCRAIL	Yellow Horizontal Rail - (ø48mm x 2160mm)	\$115.00 / ea
11-MTR-R2R-Y	Rail To Rail Brace Yellow - 1000mm	\$165.00 / set
11-MTR-W2R-Y	Wall To Rail Brace Yellow - 1000mm	\$165.00 / set
08-GSB1275X2	M12 x 75mm Galvanised Screw Bolt - Set of 2 (Requires 1 Set of Fasteners Per Base Plate)	\$4.95 / Set

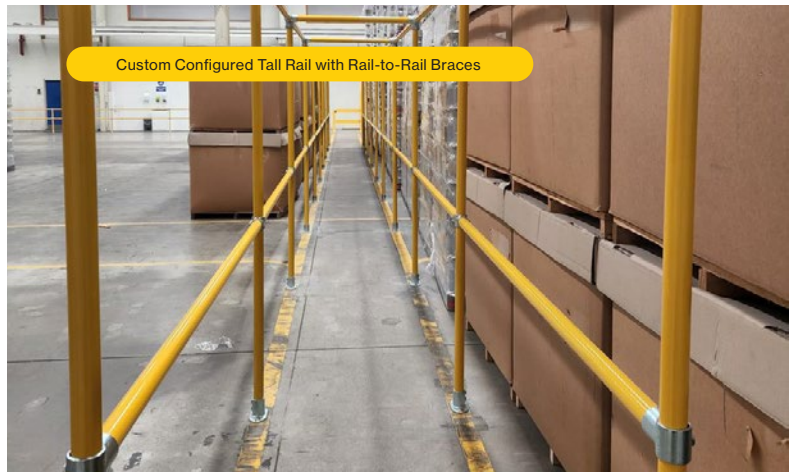
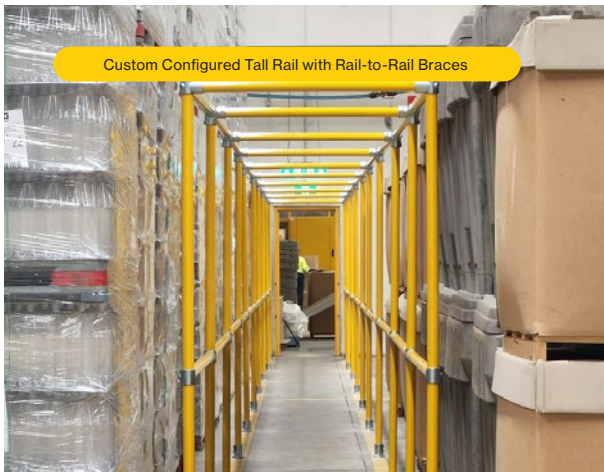

Modular Fencing



* Available with 3 different connection types



NEW

Surex Modular Fencing Panels



- Heavy duty galvanised steel
- All fittings heavy duty cast galvanised steel
- Compliant handrail height
- Custom colours available
- Perfect for footpaths and pedestrian paths that require extra safety and security

Surex Modular Pedestrian Fencing Kits (Yellow)

code	description	1+
11-MPFE-Y	End Section: 1100(H)mm x 2050(L)mm (end post & fence panel)	\$895.00 / ea
11-MPFM-Y	Mid Section: 1100(H)mm x 2050(L)mm (mid post & fence panel)	\$895.00 / ea
11-MPFC-Y	Corner Section: 1100(H)mm x 2050(L)mm (corner post & fence panel)	\$895.00 / ea
11-MPF-PE-Y	End Post: 1100(H)mm	\$179.00 / ea
11-MPF-PM-Y	Mid Post: 1100(H)mm	\$179.00 / ea
11-MPF-PC-Y	Corner Post: 1100(H)mm	\$179.00 / ea



End, Mid and Corner Posts



Modular Fencing - Yellow



Modular Fencing - Yellow



Modular Fencing - Galv (See Online)

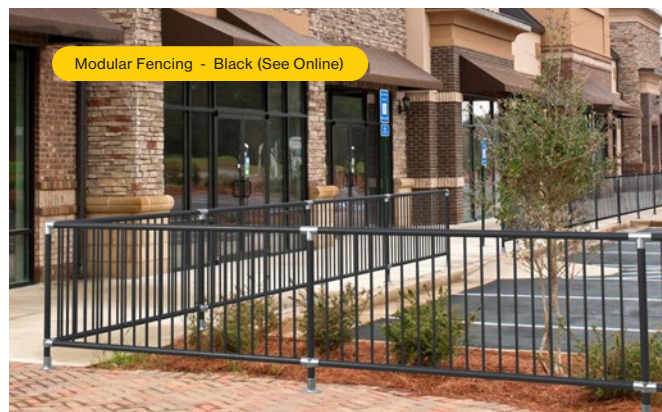

Modular Fencing - Black (See Online)



Surex 'Recessed Rail' Barrier Features

1. Premium safety yellow powder coat
2. Optional compliant handrail
3. Heavy wall steel post & rail
4. Recessed rail attachment for extra strength
5. 4 sizes options
6. Optional kick plate
7. Non-trip base plates
8. Full galvanised - no rust!



Pictured: 2m 'Recessed Rail' with Kick Plate



3m 'Recessed Rail' Kit



4m and 3m 'Recessed Rail' Kits

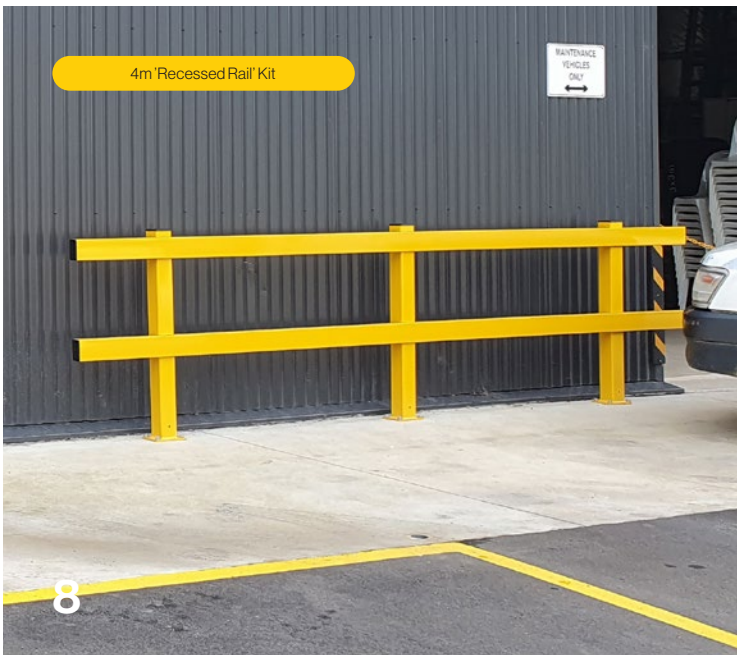

4m 'Recessed Rail' Kit

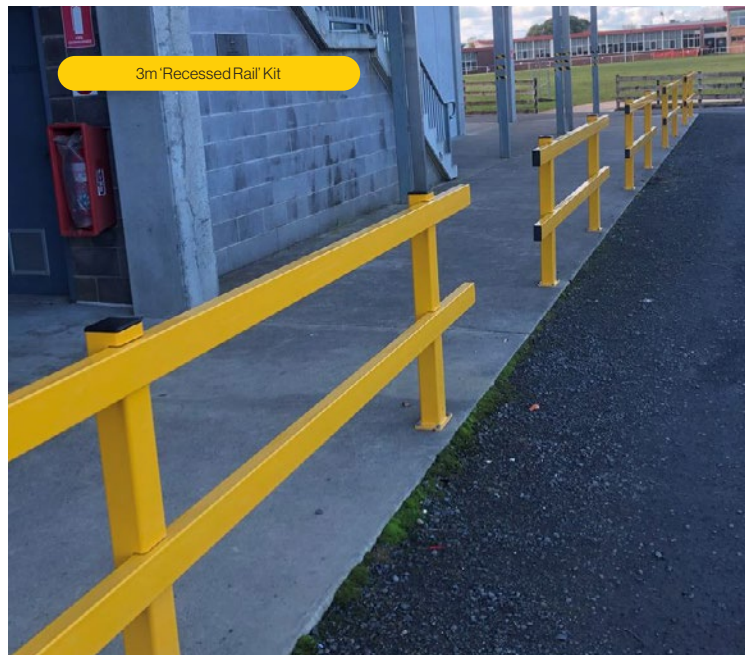

3m 'Recessed Rail' Kit

Surex 'Recessed Rail' Warehouse Barriers



Surex 'Recessed Rail' Warehouse Barrier (Powder Coated Safety Yellow)

- Heavy Wall Galvanised Steel Posts & Rails powder coated Safety Yellow
- Optional Kick Plate Available
- Post Height: 1000mm
- Rail Height: 970mm
- Custom colours available, please enquire

code	description	1+
12-SWB1	1m Post & Rail Kit	\$889.00 / set
12-SWB2	2m Post & Rail Kit	\$999.00 / set
12-SWB3	3m Post & Rail Kit	\$1,199.00 / set
12-SWB4	4m Post & Rail Kit (3 posts)	\$1,599.00 / set
08-GSB1275X4	M12 x 75mm Galvanised Screw Bolt - Set of 4 (Require 1 set of fixings per base plate)	\$9.90 / Set

Optional Kick Plate

- 100mm High
- Galvanised Steel Plate

code	description	1+
12-SWBKP1	1m Kick Plate	\$159.00 / ea
12-SWBKP2	2m Kick Plate	\$299.00 / ea
12-SWBKP3	3m Kick Plate	\$429.00 / ea
12-SWBKP4	4m Kick Plate	\$519.00 / ea

Optional Hand Rail

- Galvanised Steel Rail

code	description	1+
12-SWBHR1	1m Hand Rail Kit	\$149.00 / ea
12-SWBHR2	2m Hand Rail Kit	\$189.00 / ea
12-SWBHR3	3m Hand Rail Kit	\$229.00 / ea
12-SWBHR4	4m Hand Rail Kit	\$339.00 / ea



Surex Recessed Rail Pedestrian Gates (Standard)



- Extra Heavy Duty Galvanised Steel Construction
- Standard Gate Size: 1090(W) x 1006(H)mm (Gate Opening Width: 859mm)

code	description	1+
09-RRPGS	Standard Gate	\$1,550.00 / ea
08-GSB1275X8	M12 x 75mm Galvanised Screw Bolt - Set of 8	\$19.80 / Set

✓ See full range of Recessed Rail Pedestrian Gates on Page 87 including Audio & Visual Alarmed Gates

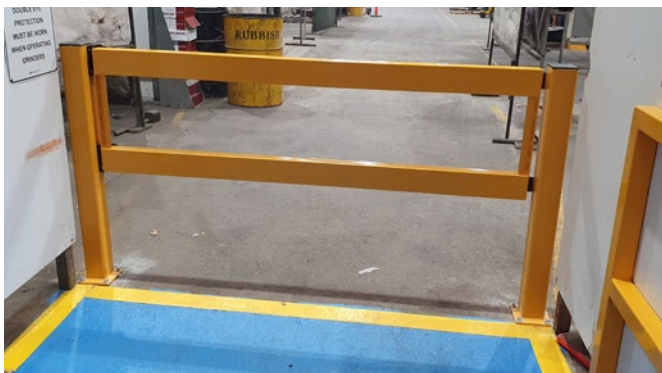

Recessed Rail Pedestrian Gates Alarmed

Surex Pedestrian Gate Features

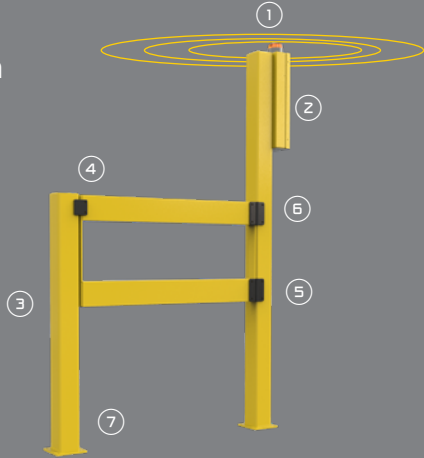

- 1. Warning light (visual)
- 2. Warning alarm (audio)
- 3. High visibility safety yellow powder coat
- 4. Heavy duty hinges
- 5. Heavy duty gate stopper
- 6. 1.66m high post for added safety visibility
- 7. Heavy duty 8mm base plates

Recessed Rail Pedestrian Gates Alarmed

- Extra Heavy Duty Galvanised Steel Construction
- Options of standard gate, gate with visual alarm, gate with audio alarm and gate with visual and audio alarm
- Standard Gate Size: 1090(W) x 1006(H)mm (Gate Opening Width: 859mm)
- Alarmed Gate Size: 1090(W) x 1665(H)mm (Gate Height: 1006mm, Gate Opening Width: 859mm)
- Alarm is activated upon opening of gate
- Alarmed Gates use 8x 'D' Batteries (Not included - client to supply)

code	description	1+
09-RRPGS	Standard Gate - No Alarm	\$1,050.00 / ea
09-RRPGAA	Gate with Audio Alarm	\$2,330.00 / ea
09-RRPGVA	Gate with Visual Alarm	\$2,330.00 / ea
09-RRPGVAA	Gate with Visual and Audio Alarm	\$2,380.00 / ea
09-WMAB-VA	Wall Mount Alarm Box (Visual & Audio)	\$699.00 / ea
08-GSB1275X8	M12 x 75mm Galvanised Screw Bolt - Set of 8	\$19.80 / Set

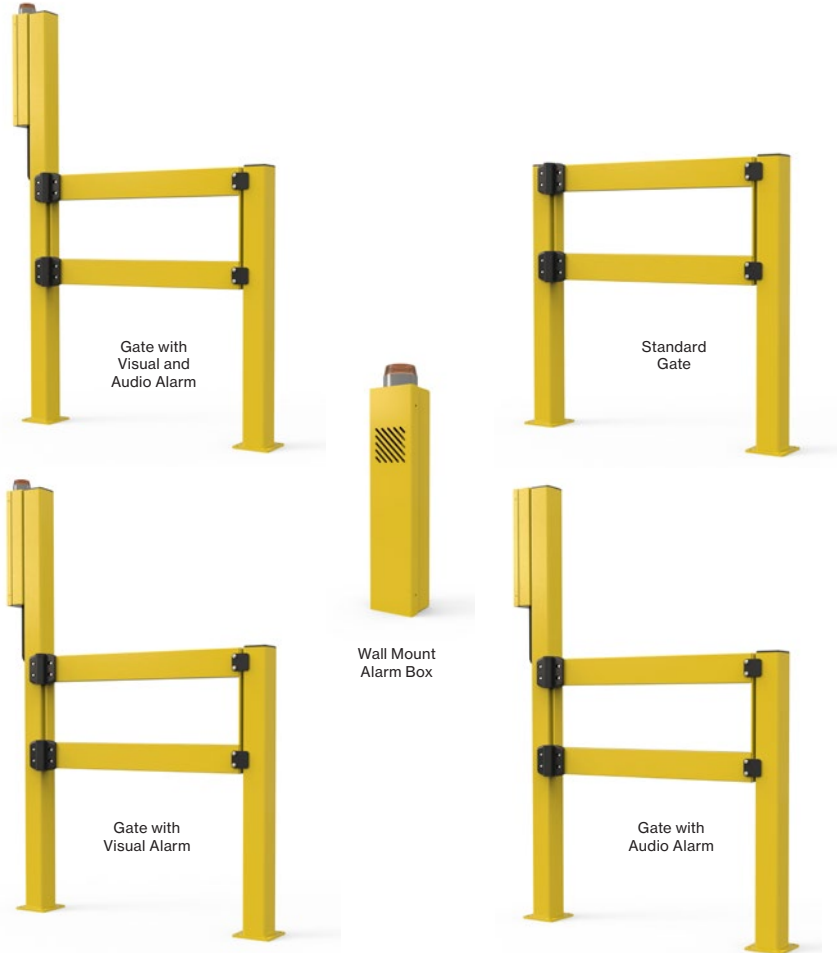
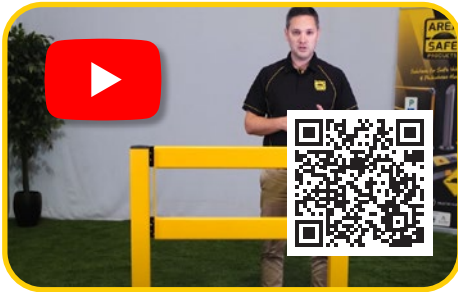

W-Beam Guard Rails Galvanised

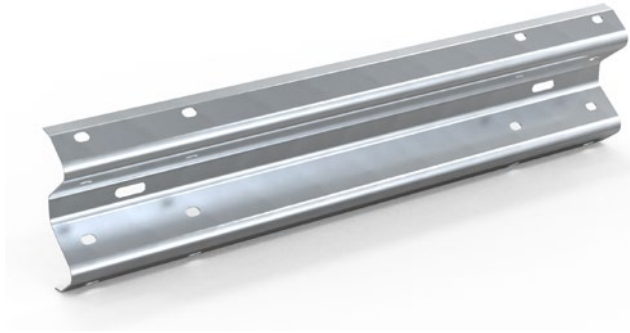

725mm

NEW

W-Beam Guard Rails Galvanised

- Galvanised finish

code	description	1+
12-WBR1	1m - W-Beam Rail (use 2 posts)	\$125.00 / ea
12-WBR2	2m - W-Beam Rail (use 2 posts)	\$249.00 / ea
12-WBR4	4m - W-Beam Rail (use 3 posts)	\$385.00 / ea
12-WB-SB	Splice Bolt/Nut (use 8 per join)	\$5.40 / ea

NEW

W-Beam Posts Galvanised

- Galvanised finish
- 1 Person install design
- Handle for easier carrying
- W-Beam Holder Bracket for easier installation

code	description	1+
12-WBCP	680mm - C-Post, Surface Mount	\$215.00 / ea
12-WBCP-D	1140mm - C-Post, Surface Mount (double height)	\$329.00 / ea
12-WBCPIG	1225mm - C-Post, In-ground	\$289.00 / ea
12-WBCPIG-D	1850mm - C-Post, In-ground (double height)	\$329.00 / ea
12-WB-PB	Post Bolt/Nut	\$5.40 / ea
12-WBPF1	Fasteners to suit Standard Height W-Beam Post M20x160mm Galvanised Through Bolt	\$10.00 / ea
12-WBPF2	Fasteners to suit Double Height W-Beam Post M20x160mm Galvanised Through Bolt (Set of 2)	\$20.00 / set

Terminal Options

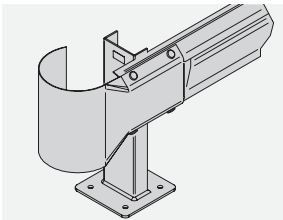

CarPark C-End

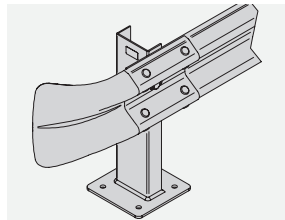

Fish Tail

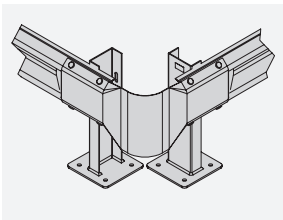

External Corner

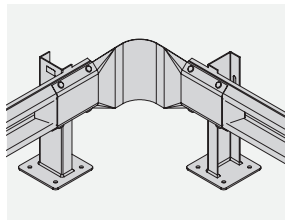

Internal Corner

NEW

W-Beam Terminals Galvanised

- Galvanised finish

code	description	1+
12-WBCE	Car Park C-End, Gal (use 4 splice bolts)	\$189.00 / ea
12-WBFT	Fish Tail - Gal (use 8 splice bolts)	\$189.00 / ea
12-WBFCE	90° Corner - External, Gal (use 8 splice bolts total)	\$365.00 / ea
12-WBFCEI	90° Corner - Internal, Gal (use 8 splice bolts total)	\$365.00 / ea
12-WB-SB	Splice Bolt/Nut	\$5.40 / ea

W-Beam Guard Rail - Galvanised Surface Mounted with Fish Tail

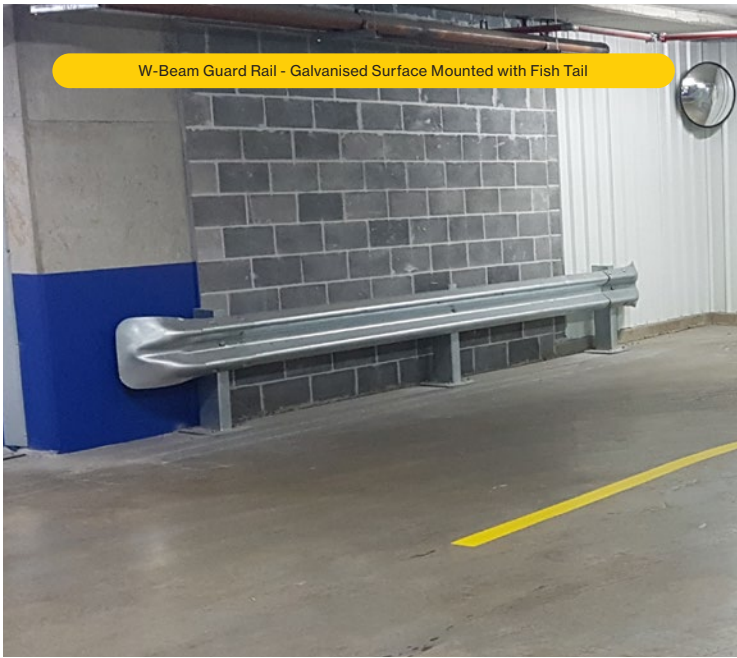

W-Beam Guard Rail - Galvanised In-ground post with Car Park C-End - Yellow



W-Beam Guard Rail - Yellow (See page 89) Surface Mounted Posts

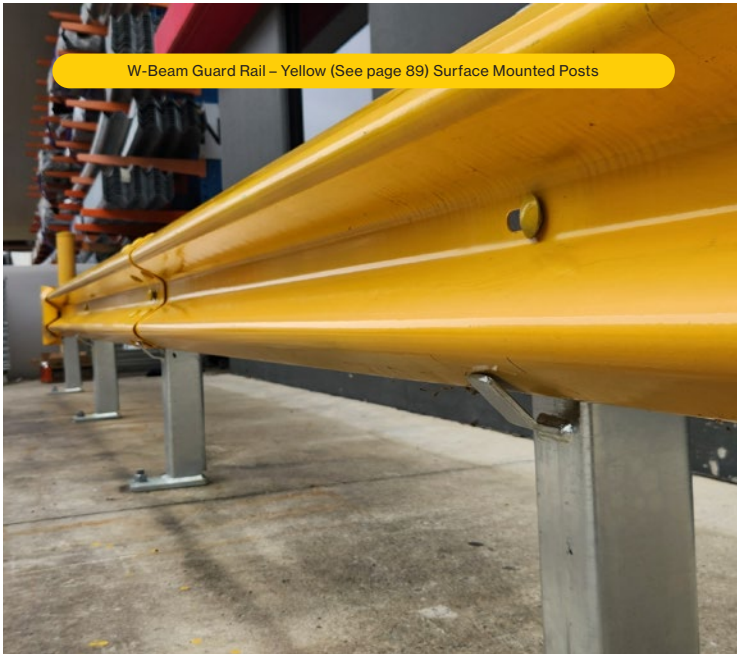

W-Beam Guard Rail - Galvanised with Car Park C-End

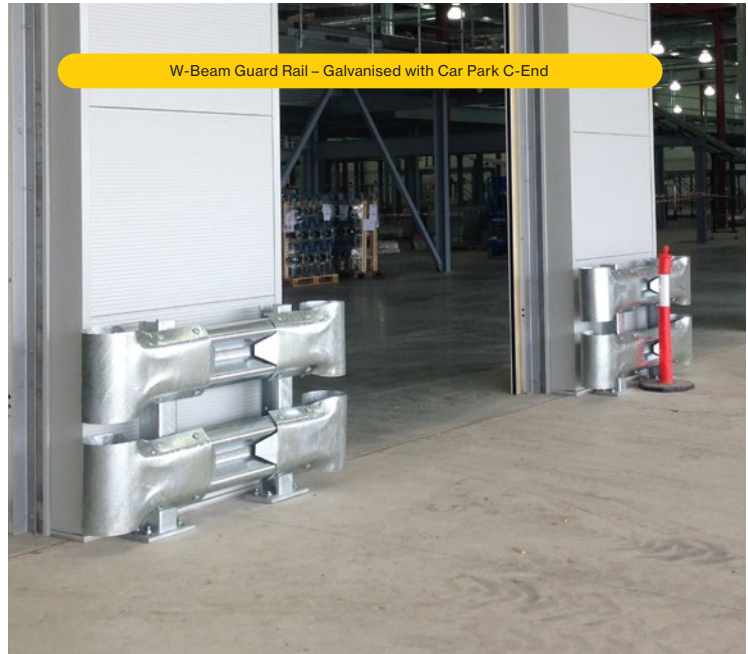

W-Beam Guard Rail - Galvanised with Car Park C-End



W-Beam Guard Rail - Galvanised Surface Mounted with Internal Corners and Car Park C-End



W-Beam Guard Rails Yellow



NEW

W-Beam Guard Rails Yellow

- Yellow finish

code	description	1+
12-WBR1-Y	1m - W-Beam Rail (use 2 posts) - Yellow	\$180.00 / ea
12-WBR2-Y	2m - W-Beam Rail (use 2 posts) - Yellow	\$355.00 / ea
12-WBR4-Y	4m - W-Beam Rail (use 3 posts) - Yellow	\$595.00 / ea
12-WB-SB	Splice Bolt / Nut (use 8 per join)	\$5.40 / ea

NEW

W-Beam Posts Yellow

- Yellow finish
- 1 Person install design
- Handle for easier carrying
- W-Beam Holder Bracket for easier installation

code	description	1+
12-WBCP-Y	680mm - C-Post, Surface Mount (standard size)	\$259.00 / ea
12-WBCP-D-Y	1140mm - C-Post, Surface Mount (double height)	\$409.00 / ea
12-WBCPIG-Y	1225mm - C-Post, In-ground	\$369.00 / ea
12-WBCPIG-D-Y	1850mm - C-Post, In-ground (double height)	\$409.00 / ea
12-WB-PB	Post Bolt / Nut	\$5.40 / ea
12-M2075X4	Ground Fixings - Gal Sleeve Anchor M20 x 75mm (Set of 4)	\$24.90 / set



Terminal Options

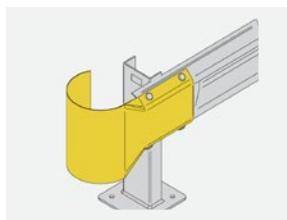

Car Park C-End

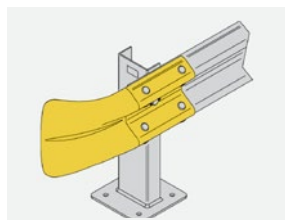

Fish Tail

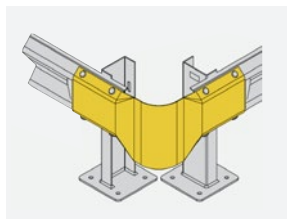

External Corner

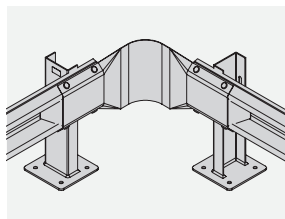

Internal Corner

NEW

W-Beam Terminals Yellow

- Yellow finish

code	description	1+
12-WBCE-Y	Car Park C-End, Yellow (use 4 splice bolts)	\$259.00 / ea
12-WBFT-Y	Fish Tail - Yellow (use 8 splice bolts)	\$259.00 / ea
12-WBFCE-Y	90° Corner - External, Yellow (use 8 splice bolts total)	\$425.00 / ea
12-WBFCE-Y	90° Corner - Internal, Yellow (use 8 splice bolts total)	\$425.00 / ea
12-WB-SB	Splice Bolt / Nut	\$5.40 / ea

Driver Safe Zone Kits



Driver Safe Zones Recessed Rail Kit (Heavy Duty)

- Overall Footprint: 3000mm x 2000mm
- Kit Includes:
 - 3 x 2m Recessed Rail
 - Standard Recessed Rail Gate
 - 2x 2m Aluminium Benches (Optional)

code	description	1+
12-DSZ-RR	Driver Safe Zone - Recessed Rail Kit	\$4,250.00 / ea
12-DSZ-RRB	Driver Safe Zone - Recessed Rail Kit (With Benches)	\$4,940.00 / ea
08-GSB1275X4	M12 x 75mm Galvanised Screw Bolt - Set of 4 (Requires 1 Set of Fasteners Per Base Plate)	\$9.90 / Set



Driver Safe Zones Double Rail U-Bollard Kit (Pedestrian Duty)

- Overall Footprint: 3200mm x 2200mm
- Kit Includes:
 - 3 x 2m Double Rail U-Bollard
 - 2 x 90mm Yellow Bollards
 - 1 x 900mm Pedestrian Gate
 - 2x 2m Aluminium Benches (Optional)

code	description	1+
12-DSZ-DRU	Driver Safe Zones - Double Rail U-Bollard Kit	\$2,399.00 / ea
12-DSZ-DRUB	Driver Safe Zones - Double Rail U-Bollard Kit (With Benches)	\$3,169.00 / ea
08-GSB1275X4	M12 x 75mm Galvanised Screw Bolt - Set of 4 (Requires 1 Set of Fasteners Per Base Plate)	\$9.90 / Set



Driver Safe Zones Modular Pedestrian Rail Kit (Pedestrian Duty)

- Overall Footprint: 3200mm x 2200mm
- Kit Includes:
 - 3 x 2.2m Modular Rail Kits
 - 1 x 900mm Pedestrian Gate
 - 2x 2m Aluminium Benches (Optional)

code	description	1+
12-DSZ-MPR	Driver Safe Zone - Modular Pedestrian Rail Kit	\$1,890.00 / ea
12-DSZ-MPRB	Driver Safe Zone - Modular Pedestrian Rail Kit (With Benches)	\$2,690.00 / ea
08-GSB1275X2	M12 x 75mm Galvanised Screw Bolt - Set of 2 (Requires 1 Set of Fasteners Per Base Plate)	\$4.95 / Set

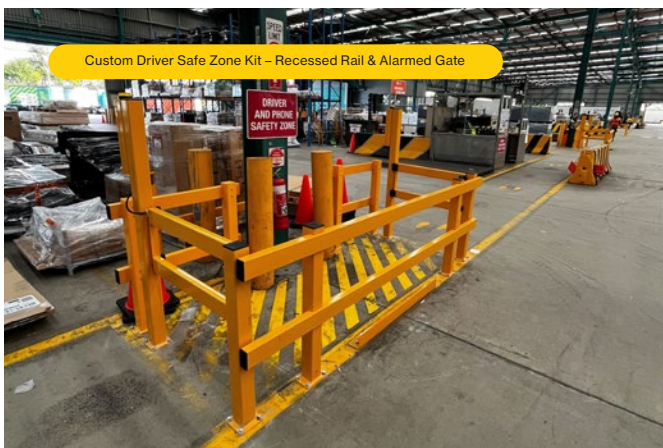

Double Rail U-Bollards



Double Rail U Bollards Bolt Down - Galvanised

■ Size: Ø48 x 1040(H)mm

code	description	1+
09-DRB10-BP	1m Long Double Rail U Bollard Surface Mount	\$219.00 / ea
09-DRB15-BP	1.5m Long Double Rail U Bollard Surface Mount	\$249.00 / ea
09-DRB20-BP	2m Long Double Rail U Bollard Surface Mount	\$295.00 / ea
08-GSB1275X4	M12 x 75mm Galvanised Screw Bolt - Set of 4	\$9.90 / Set

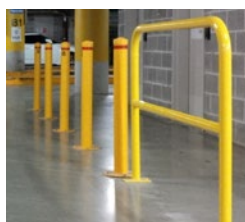

Double Rail U Bollards Bolt Down - Galvanised Powder Coated Yellow

■ Size: Ø48 x 1040(H)mm

code	description	1+
09-DRB10-BP-Y	1m Long Double Rail U Bollard Surface Mount	\$319.00 / ea
09-DRB15-BP-Y	1.5m Long Double Rail U Bollard Surface Mount	\$379.00 / ea
09-DRB20-BP-Y	2m Long Double Rail U Bollard Surface Mount	\$459.00 / ea
08-GSB1275X4	M12 x 75mm Galvanised Screw Bolt - Set of 4	\$9.90 / Set



U-Bar Bollards 90mm Heavy Duty - Galvanised Powder Coated Yellow

- Galvanised finish - Powder Coated Yellow
- Heavy 5mm wall thickness

code	description	1+
09-UBY10-BP	1m Long U Bollard Surface Mount - Size: 1000(L) x 700(H)mm, 31kg	\$919.00 / ea
09-UBY10-IG	1m Long U Bollard In-ground - Size: 1000(L) x 1200(H)mm, 31kg	\$999.00 / ea
09-UBY15-BP	1.5m Long U Bollard Surface Mount - Size: 1500(L) x 700(H)mm, 36kg	\$1,075.00 / ea
09-UBY15-IG	1.5m Long U Bollard In-ground - Size: 1500(L) x 1200(H)mm, 36kg	\$1,229.00 / ea
09-UBY20-BP	2m Long Mount U Bollard Surface - Size: 2000(L) x 700(H)mm, 41kg	\$1,239.00 / ea
08-GSB1275X8	M12 x 75mm Galvanised Screw Bolt - Set of 8	\$19.80 / Set

Industrial Expanding Barriers & Belt Barriers

See Online



Heavy Duty Industrial Swing Gate Manual

1. Heavy duty ballbearing hinge
2. Reflective strips & standard or customised messages also available
3. Aluminium beam for easy opening & closing
4. 2m, 3m or 4m length options
5. Wall, post or bollard mounting options
6. Galvanised steel support braces for added support
7. Premium powder coat finish (yellow or black)
8. Gate receiver also available

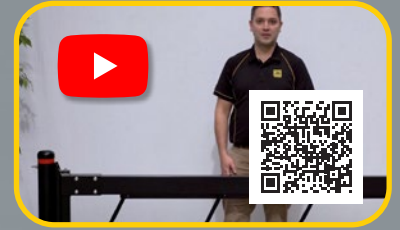
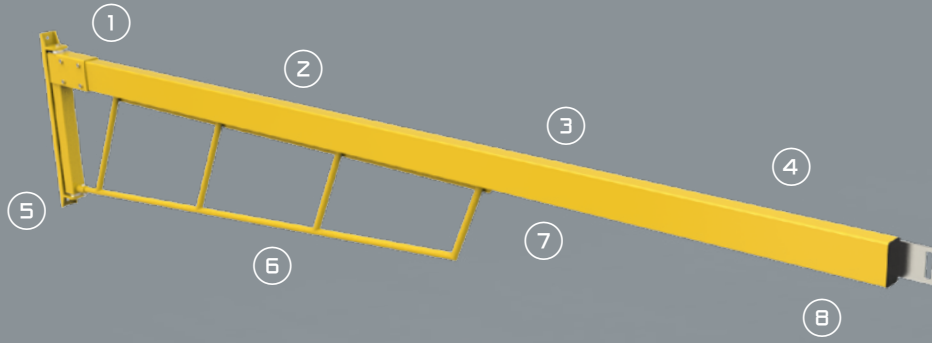

Heavy Duty Industrial Swing Gate - Manual - Black 4m & Pedestrian Modular Rail Black



Heavy Duty Industrial Swing Gate - Manual - Yellow 3m

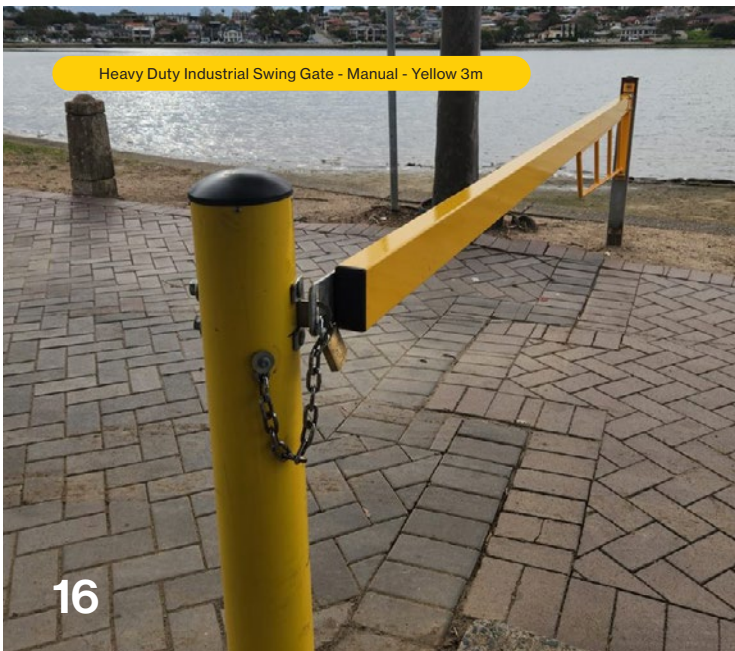

Heavy Duty Industrial Swing Gate - Manual - Yellow 3m



Manual Swing Gates



2m Black



3m Yellow with Standard Message



3m Black with Black & Yellow Reflective Tape

Heavy Duty Industrial Swing Gate Manual

- Aluminium beam, steel supports & hinge
- Heavy duty ballbearing hinge (180° swing arc)
- Colours: Yellow or Black (custom colours available)
- Wall or post / bollard mounting

code	description	1+
09-SGM2-Y/B	2m Swing Gate	\$1,720.00 / ea
09-SGM3-Y/B	3m Swing Gate	\$1,860.00 / ea
09-SGM4-Y/B	4m Swing Gate	\$2,110.00 / ea
09-SGM-R	Gate Receiver	\$59.90 / ea
09-SGMF	Fastener Kit for bolting swing gate to bollard (2x Gal Bolt & Nut M10 x 170mm with washers)	\$9.90 / kit
08-SF140BP	Fixed Base Plate Bollard (Round base plate) 5mm Wall - Ø140 x 1200(H)mm - 25kg	\$299.00 / ea

Standard Messaging Applied to Gate Arm 1 Side

- (Purchase x2 for both sides)

code	description	1+
09-AVO12	AUTHORISED VEHICLES ONLY	\$129.00 / ea
09-KCT12	KEEP CLEAR AT ALL TIMES	\$129.00 / ea
09-NOE12	NO ENTRY	\$129.00 / ea
09-NOP12	NO PARKING	\$129.00 / ea
09-NPAT12	NO PARKING AT ANY TIME	\$129.00 / ea
09-GT-REFL- (Length)	 Specify Length (2m, 3m, 4m)	\$99.00 / ea

Manual Swing Gate Aluminium

- Wall mounting
- Bollard mounting
- Adjustable
- 3 standard sizes
- 270° swing
- Padlock not supplied. Some assembly on site - assembly guide is available.

code	description	1+
09-MSGM2	Aluminium Swing Gate 2400mm	\$699.00 / ea
09-MSGM3	Aluminium Swing Gate 3400mm	\$819.00 / ea
09-MSGM4	Aluminium Swing Gate 4400mm	\$939.00 / ea
09-MSGM-R	Gate Receiver	\$55.00 / ea
08-SF140BP	Fixed Base Plate Bollard (Round base plate) 5mm Wall - Ø140 x 1200(H)mm - 25kg	\$299.00 / ea



Gate Receiver

Boom Gate Single Arm



2m Industrial Boom Gate – Black



2m Industrial Boom Gate – Yellow

Heavy Duty Manual Industrial Boom Gate

- Full Aluminium Construction
- Premium gas strut for smooth raising & lowering
- 3 boom lengths
- Colours: Yellow or Black (custom colours available)
- Lockable receiver post

code	description	opening measurement	1+
09-HDMBG-2-B	2m Industrial Boom Gate - Black	1720mm	\$2,240.00 / ea
09-HDMBG-2-Y	2m Industrial Boom Gate - Yellow	1720mm	\$2,240.00 / ea
09-HDMBG-3	3m Industrial Boom Gate	2720mm	\$2,499.00 / ea
09-HDMBG-4	4m Industrial Boom Gate	3720mm	\$2,690.00 / ea
08-GSB1275X8	M12 x 75mm Galvanised Screw Bolt - Set of 8		\$19.80 / Set

Standard Messaging Applied to Gate Boom 1 Side

- (Purchase x2 for both sides)
- Assisted raising and lowering of the boom arm

code	description	1+
09-AVO12	AUTHORISED VEHICLES ONLY	\$129.00 / ea
09-KCT12	KEEP CLEAR AT ALL TIMES	\$129.00 / ea
09-NOE12	NO ENTRY	\$129.00 / ea
09-NOP12	NO PARKING	\$129.00 / ea
09-NPAT12	NO PARKING AT ANY TIME	\$129.00 / ea
09-GT-REFL-(Length)	 Specify Length (2m, 3m, 4m)	\$99.00 / ea

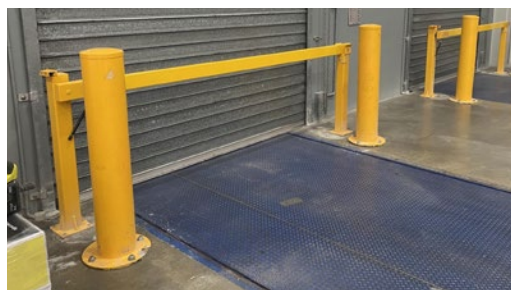

Boom Gates Double Knuckle Arm

NEW

Heavy Duty Knuckle Boom Gate 2.5m

- Overall Size: 1080(H) x 2965(L) x 150(W)mm
- Opening Width: 2500mm
- Fully Raised Height: 3183mm
- Heavy duty Aluminium construction
- Powder Coated: Dulux Safety Yellow
- Articulating Boom to reduce raised height
- Premium gas strut for smooth raising & lowering

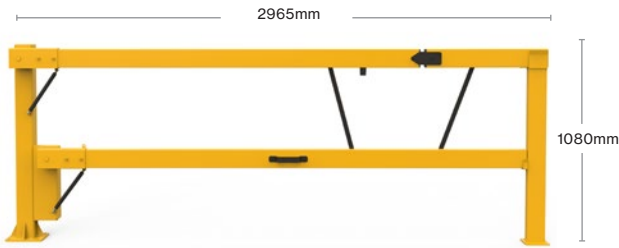

code	description	1+
09-HDKBG-2.5	Overall Size: 1080(H) x 2886(L) x 150(W)mm Opening Width: 2500mm Fully Raised Height: 3155mm Assembly Required Note: Assisted raising and lowering of the boom arms	\$2,790.00 / ea

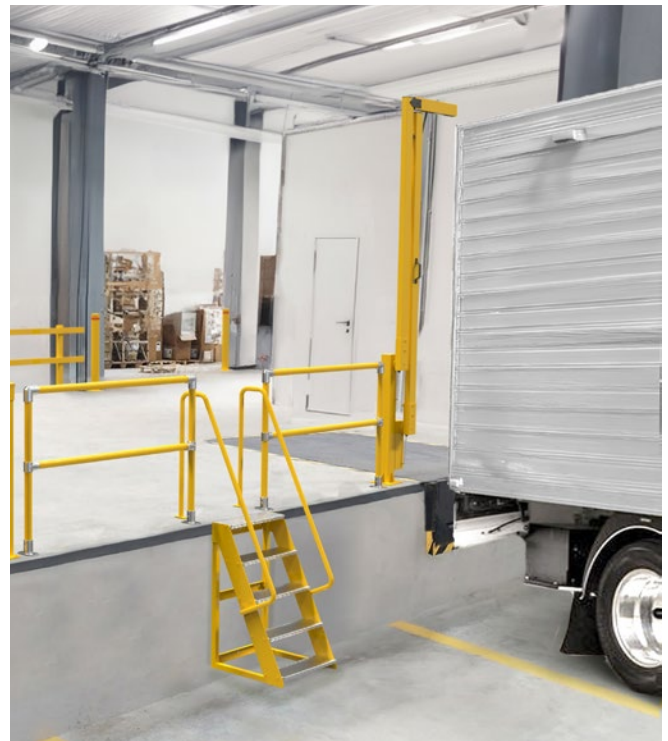
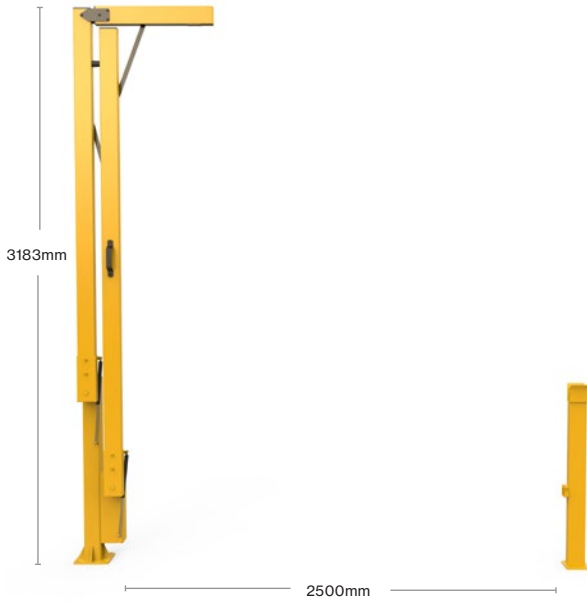

Double Arm Boom Gate & Recessed Rails



3m Double Arm Boom Gate

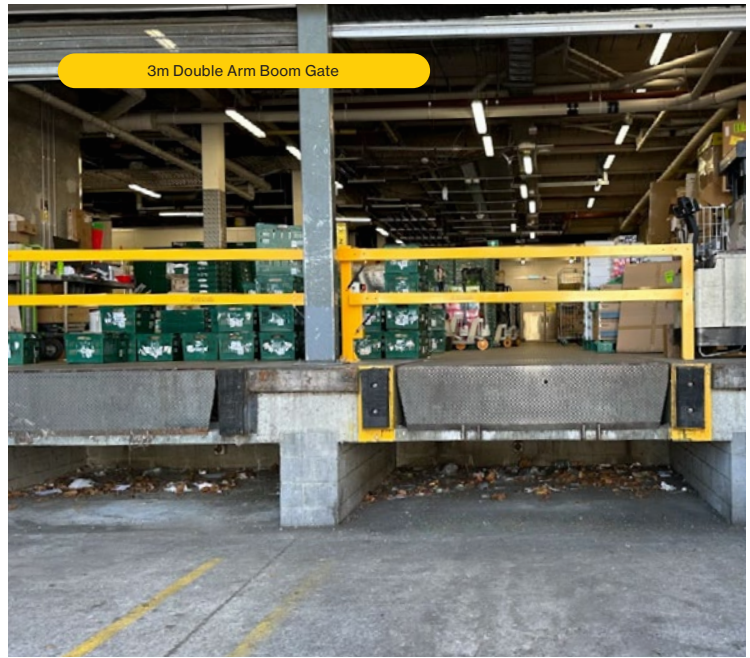

3m Double Arm Boom Gate



3m Double Arm Boom Gate



3m Double Arm Boom Gate & Modular Pedestrian Rail



3m Double Arm Boom Gate



Boom Gates Double Arm

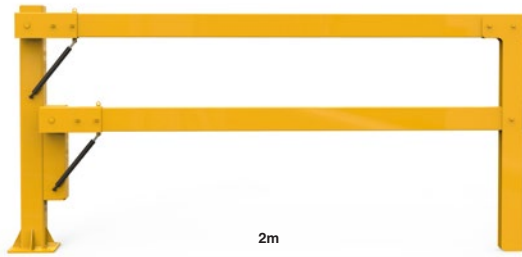

2m



2m Part Open

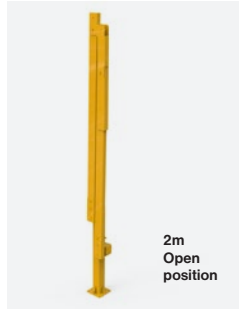

2m Open position

Heavy Duty Manual Boom Gates Double Arm

- Heavy duty aluminium construction
 - Premium gas strut for smooth raising & lowering
 - 3 boom lengths: 2m, 3m, 4m
 - Assisted raising and lowering of the boom arm
- Boom heights when open**
- 2m Boom: 3095mm (H)
 - 3m Boom: 4095mm (H)
 - 4m Boom: 5095mm (H)
 - Powder coated premium safety yellow

code	description	1+
09-MBGDA-2-LH	2m Double Arm Boom Gate - Left Hand Mount	\$2,590.00 / ea
09-MBGDA-3-LH	3m Double Arm Boom Gate - Left Hand Mount	\$2,740.00 / ea
09-MBGDA-4-LH	4m Double Arm Boom Gate - Left Hand Mount	\$2,880.00 / ea
09-MBGDA-2-RH	2m Double Arm Boom Gate - Right Hand Mount	\$2,590.00 / ea
09-MBGDA-3-RH	3m Double Arm Boom Gate - Right Hand Mount	\$2,740.00 / ea
09-MBGDA-4-RH	4m Double Arm Boom Gate - Right Hand Mount	\$2,880.00 / ea
08-GSB1275X4	M12 x 75mm Gal Screw Bolt and Washer - Set of 4	\$9.90 / Set

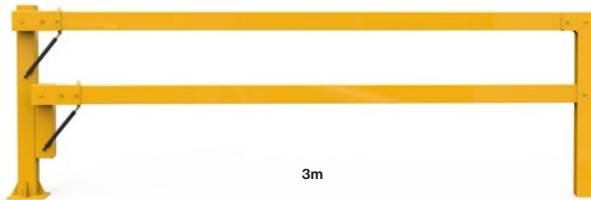

3m

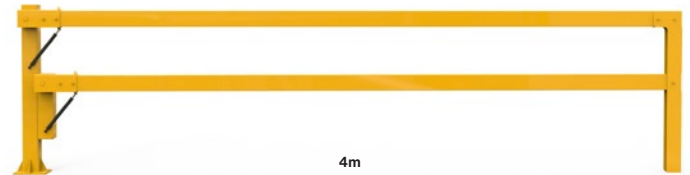

4m



3m Part Open

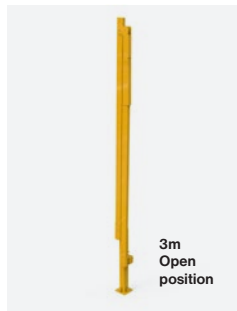

3m Open position



4m Part Open

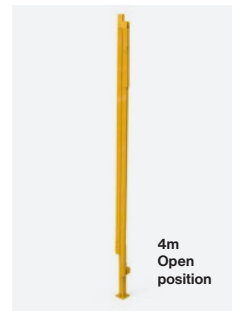

4m Open position

Industrial Safety Signs

See Online



INDUSTRIAL SAFETY Boom Gates

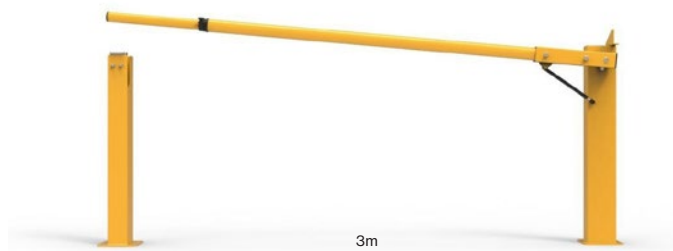

3m

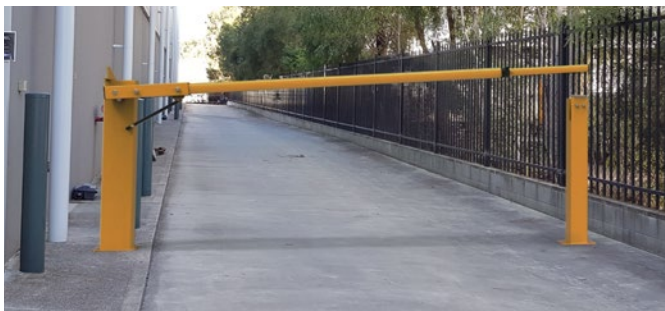

Manual Telescopic Boom Gate

- Max. Opening 3825mm (telescopic)
- Min. Opening 2325mm
- Rail Height 940mm (to centre)
- O/H Clearance 3450mm (for minimum length boom)
- Assisted raising and lowering of the boom arm

code		1+
09-TBG38		\$2,550.00 / ea
08-GSB1275X8	M12 x 75mm Galvanised Screw Bolt - Set of 8	\$19.80 / Set

Manual Telescopic Boom Gate Dual Arm

- Max. Opening 3825mm (telescopic)
- Min. Opening 2464mm
- Rail Height 940mm (to centre)
- O/H Clearance 4981mm (for minimum length boom)
- Note: Assisted raising and lowering of the boom arm

code		1+
09-TBG38-DA		\$4,790.00 / ea
08-GSB1275X4	M12 x 75mm Galvanised Screw Bolt - Set of 4	\$9.90 / Set

Double Safety Boom Gate

- Creates air-lock safety zone
- Protects workers from exposed edges
- Optional double rail U-bollards can be installed as side infills if required.
- Assisted raising and lowering of the boom arm

code	description	1+
09-DBG15	Double Safety Boom Gate	\$5,499.00 / ea
09-DRB15-BP-Y	Double Rails U-Bollard - Yellow	\$379.00 / ea
08-GSB1275X4	M12 x 75mm Galvanised Screw Bolt - Set of 4 (Requires 1 Set of Fixings per base plate)	\$9.80 / Set

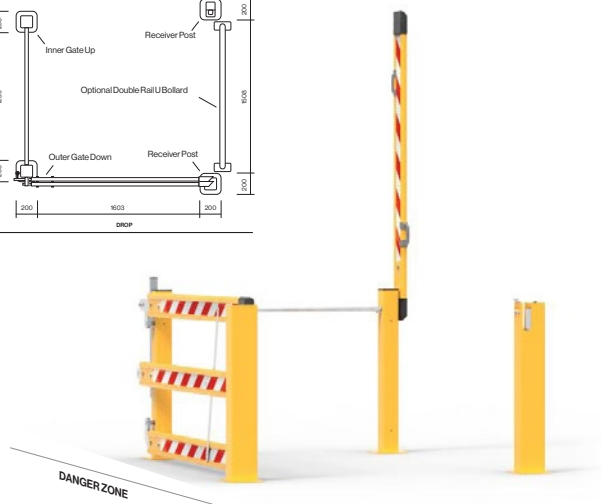
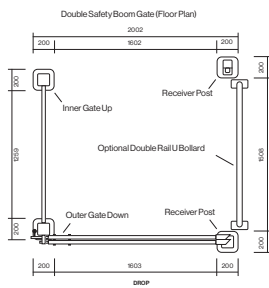

Loading Dock Stairs



NEW

Heavy Duty Loading Dock Stairs

- Heavy Duty Steel Frame
- Aluminium Checker Plate Steps
- Compliant Dimensions: 696mm(W) x 902mm(H) x 640mm(D)
- Heavy Duty Handrail
- Powdercoated Safety Yellow
- Fix the stairs to the side of the loading dock with screw bolts or similar. Handrail to be fixed to the top of the loading dock and the side of the stairs.

code	1+
12-LD-STAIRS	\$1,950.00/ea

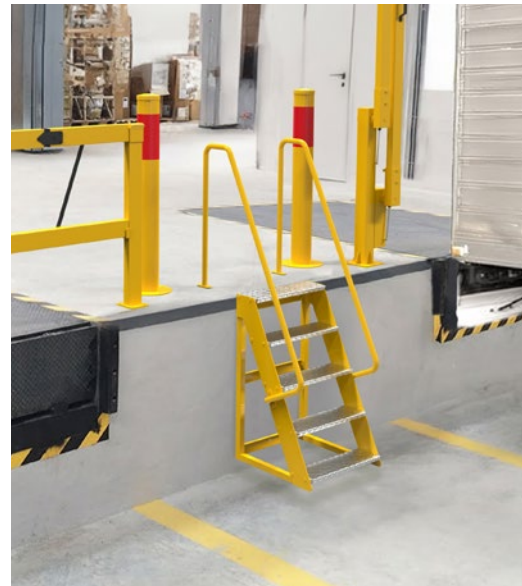

'Tall Rail' Kits

See Page 6

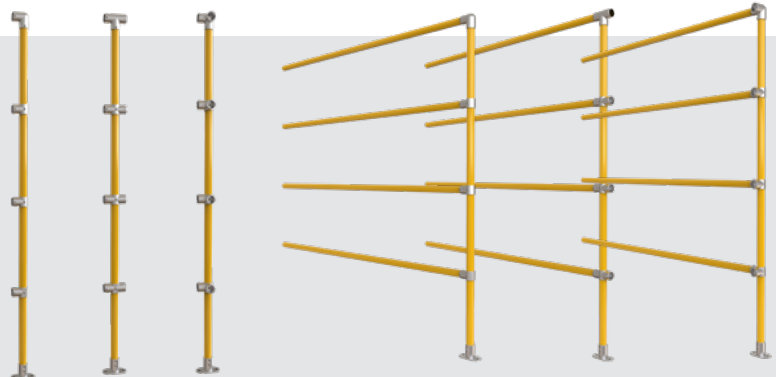

Machine Guarding

NEW

Surex Machine Guarding



- Manufactured from 25 x 25 x 1.6mm thick SHS tube
- Quick and easy installation
- Flexible system mainly applicable to warehouses and factories
- Available in safety yellow or black

2000mm high screens and posts

code	description	1+
12-SMS20-POST-Y	Tall post yellow: 75 x 75 x 2140(H)mm	\$299.00 / ea
12-SMS20-PANEL-Y	Yellow screen with 4 brackets: 2040(H) x 1220(W)mm	\$279.00 / ea
12-SMS20-PANEL-B	Black screen with 4 brackets: 2040(H) x 1220(W)mm	\$279.00 / ea

1200mm high screens and posts

code	description	1+
12-SMS12-POST-Y	Post yellow: 75 x 75 x 1340(H)mm	\$199.00 / ea
12-SMS12-P1000-Y	Yellow screen with 4 brackets: 1240(H) x 1020(W)mm	\$179.00 / ea
12-SMS12-P1000-B	Black screen with 4 brackets: 1240(H) x 1020(W)mm	\$179.00 / ea
12-SMS12-P2400-Y	Yellow screen with 4 brackets: 1240(H) x 2020(L)mm	\$279.00 / ea
12-SMS12-P2400-B	Black screen with 4 brackets: 1240(H) x 2020(L)mm	\$279.00 / ea

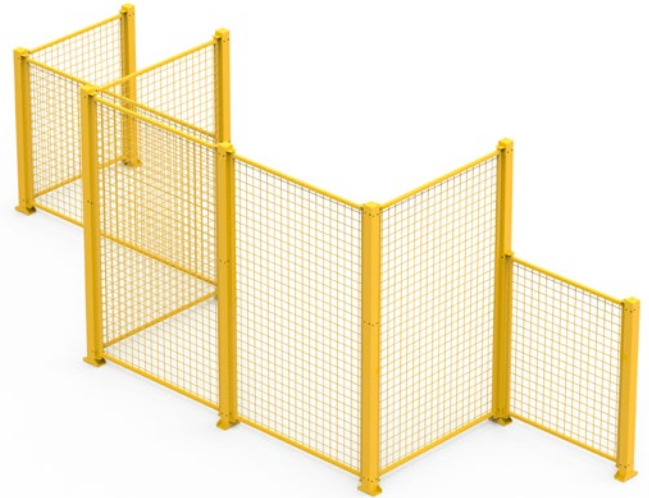

Example configuration using all sizes of screens and posts.

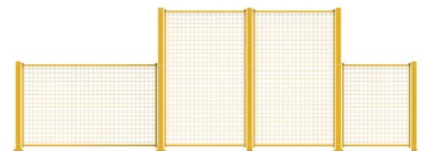

* Modular Machine Guarding example

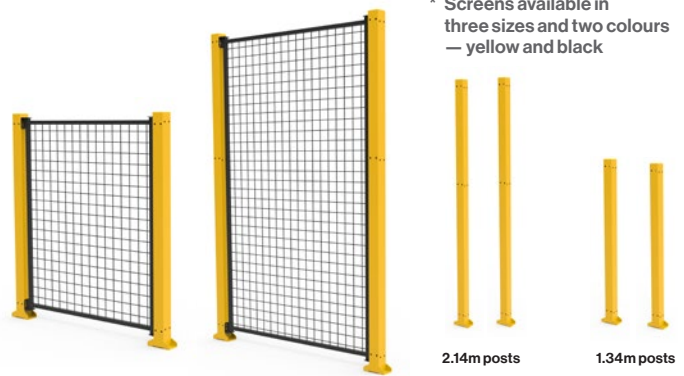
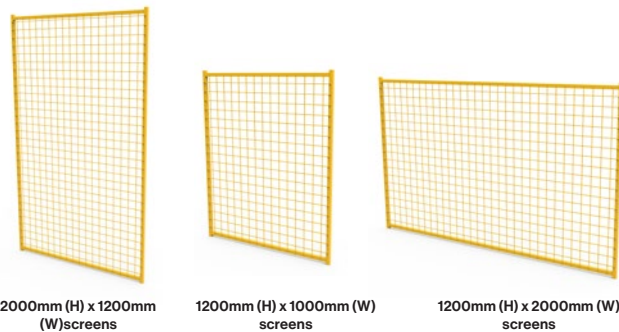
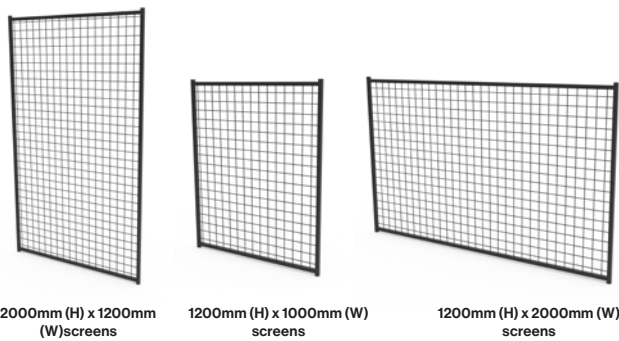

* Screens available in three sizes and two colours — yellow and black



Machine Guarding

NEW

Surex Machine Guarding Gate



- Manufactured from 25 x 25 x 1.6mm thick SHS tube
- Available in safety yellow or black
- Quick and easy installation
- Flexible system mainly applicable to warehouses and factories

code	description	1+
12-SMS12-GATE-B	Black with heavy duty hinges and lockable latch 1240(H) x 1020(W)	\$429.00 / ea
12-SMS12-GATE-Y	Yellow with heavy duty hinges and lockable latch 1240(H) x 1020(W)	\$429.00 / ea
12-SMS20-GATE-B	Black with heavy duty hinges and lockable latch 2040(H) x 1220(W)	\$639.00 / ea
12-SMS20-GATE-Y	Yellow with heavy duty hinges and lockable latch 2040(H) x 1220(W)	\$639.00 / ea



2140mm high screens and posts with gate section

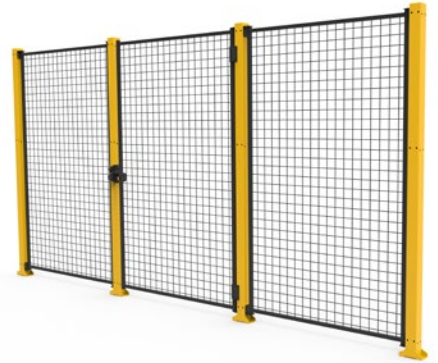

1200mm high screens with posts and gate section



Downpipe Guards



Galvanized Steel Downpipe Protectors

- Industrial 2mm thickness (3mm available - please enquire)
- Galvanised
- Side flanges 50mm wide
- Pre-drilled Ø14 fixing holes

code	description	1+
21-GDP150	150(W) x 150(D) x 1200(H) x 2mm	\$179.00 / ea
21-GDP200	200(W) x 200(D) x 1200(H) x 2mm	\$199.00 / ea
21-GDP250	250(W) x 250(D) x 1200(H) x 2mm	\$225.00 / ea



Yellow Downpipe Protectors

- Industrial 2mm thickness (3mm available - please enquire)
- powder coat Safety Yellow
- Side flanges 50mm wide
- Pre-drilled Ø14 fixing holes

code	description	1+
21-GDP150-Y	150(W) x 150(D) x 1200(H) x 2mm	\$288.00 / ea
21-GDP200-Y	200(W) x 200(D) x 1200(H) x 2mm	\$319.00 / ea
21-GDP250-Y	250(W) x 250(D) x 1200(H) x 2mm	\$359.00 / ea

Fixed Steel Bollards - Yellow (Base Plate)

See Online



Surex Low Recessed Rails



NEW

Surex Low Recessed Rail

- Heavy wall galvanised steel posts and rails
- Powder coated safety yellow
- Size: 124.5mm (W) x 211.5mm (H)
- Custom colours and lengths available, please enquire
- Lengths: 1m, 2m, 3m and 4m

Surex Low Recessed Rail Features

1. Premium safety yellow powder coat
2. Heavy wall steel post & rail
3. Recessed rail attachment for extra strength
4. 4 sizes options
5. Non-trip base plates
6. Full galvanised - no rust!

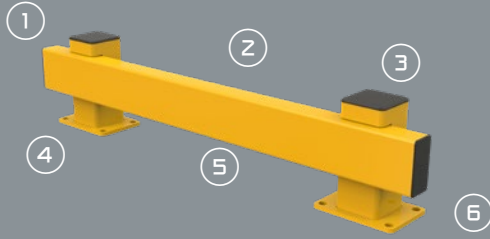

code	description	1+
12-SRLR1	1m Low Recessed Rail	\$585.00 / set
12-SRLR2	2m Low Recessed Rail	\$699.00 / set
12-SRLR3	3m Low Recessed Rail	\$825.00 / set
12-SRLR4	4m Low Recessed Rail	\$995.00 / set
08-GSB1275X4	M12 x 75mm Galvanised Screw Bolt - Set of 4 (Require 1 set of fixings per base plate)	\$9.90 / set



1m Low Recessed Rail



2m Low Recessed Rail



3m Low Recessed Rail



4m Low Recessed Rail



Surex Low Recessed Rail



Steel Truck Loading Dock Reversing Guides



Surex Heavy Duty Floor Angle



- Very heavy duty floor stop, ideal for stopping pallets hitting and damaging walls or barriers

code	description	1+	10+
12-HDFA12	100x100x5(T) x 1200(L)mm	\$249.00 / ea	\$219.00 / ea
12-HDFA24	100x100x5(T) x 2400(L)mm	\$329.00 / ea	\$299.00 / ea
08-GSB1275X4	M12 x 75mm Galvanised Screw Bolt - Set of 4	\$9.90 / Set	

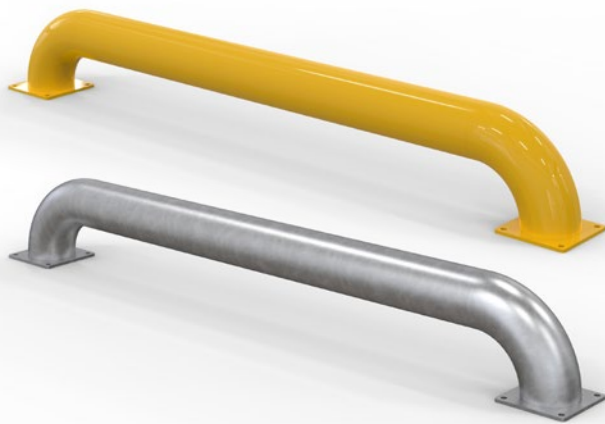

Galvanised Steel Truck Loading Dock Reversing Guides

- Size: 2303(L) x 220(W) x 311(H)mm (Diameter 165mm)
- Finish: Yellow & Galvanised

code	description	1+
07-STWSC-Y	Yellow	\$1595.00 / ea
07-STWSC-G	Galvanised	\$1495.00 / ea
08-GBM16110	Galvanised M16x110mm Sleeve Anchor with Washer (8 required per reversing guide)	\$4.20
08-GSB16100X4	M16 x 100mm Galvanised Screw Bolt - Set of 4 (Requires 2 sets per base plate)	\$23.90 / Set



NEW

Pallet Racking Guards

- Safety Yellow
- Complies to AS4084-2023
- Suit 90-100mm Pallet Racking Uprights



Plastic

Steel

Installation Tool

code	description	1+
12-PRG400-S	Pallet Racking Guard - Steel 400mm 223.5 (W) x 400 (H)mm	\$139.00 / ea
12-PRG600-P	Pallet Racking Guard - Plastic 600mm 144 (W) x 600 (H)mm	\$159.00 / ea
12-PPRG-TOOL	Plastic Pallet Racking Guard Installation Tool Makes installing the plastic pallet racking guard very simple.	\$649.00 / ea

Corner Guards



Stainless Steel Corner Guard (No Holes)

- Size: 40 x 40 x 1200(L)mm
- Thickness: 1.6mm

code	1-9	10-24	25+
21-SSCG40	\$89.00/ea	\$79.00/ea	\$65.00/ea



Galvanised Steel Corner Guard

50mm Profile (no holes)

- Size: 50 x 50 x 1200(L)mm
- Thickness: 2mm

100mm Profile (with holes)

- Size: 100 x 100 x 1200(L)mm
- Thickness: 3mm

code	description	1-9	10+
21-GCG-50	50mm	\$65.90/ea	\$59.90/ea
21-GCG	100mm	\$119.00/ea	\$108.00/ea

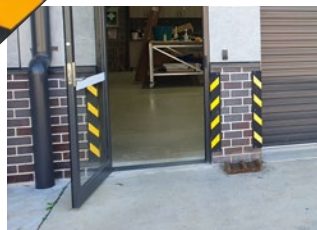

Rubber Corner Guard

- Size: 100 x 100 angle x 800(L)mm
- Colour: Black/Yellow Hi-Vis or Plain Black

code	description	1-9	10+
21-RCP-BY	Black/Yellow	\$32.00/ea	\$26.50/ea
21-RCP-B	Plain Black	\$32.00/ea	\$26.50/ea



PVC Corner Guard

- Size: 50 x 50 x 1200(L)mm
- Thickness: 2.5mm
- Colour: White

code	1-9	20+
21-PVC5012	\$74.90/ea	\$62.90/ea

* Small order charge \$25.00+GST for less than 10.

Rubber Guards

Extruded Rubber Dock Fender

- Size: 92(D) x 105(H) x 2400(L)mm
- Thickness: 19.5mm

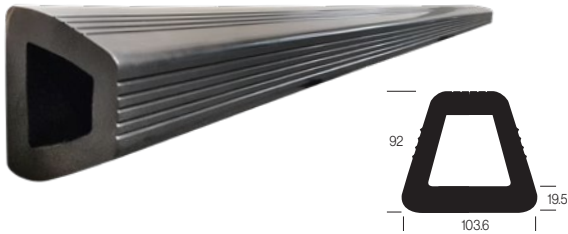

code	1+
21-RDF	\$419.00 / ea

D Type Moulded Rubber Dock Bumper

- Size: 100(D) x 100(H) x 900(L)mm
- Thickness: 25mm
- Non-flexible



code	1-9	10+
21-RDDB	\$69.90 / ea	\$57.80 / ea

Extruded Rubber Wall Guard

- Size: 40(D) x 50(H) x 3000(L)mm
- Thickness: 8mm

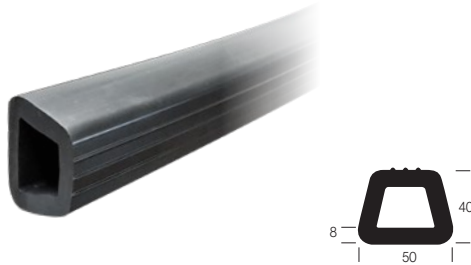

code	1+
21-RWG	\$199.00 / ea

Rubber Dock Bumper

- Size: 100(D) x 330(H) x 250(W)mm

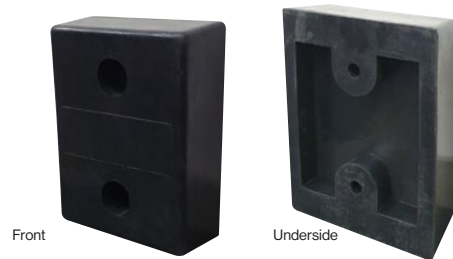

code	1-9	10+
21-RDB	\$145.00 / ea	\$129.00 / ea

Rubber Wall Protector

- Size: 55(D) x 150(H) x 1000(L)mm



code	1-9	10+
21-RWP	\$49.90 / ea	\$42.50 / ea

Heavy Duty Wall & Column Protector

- Size: 40(D) x 115(H) x 5000(L)mm



code	1-4	5+
28-RBS115	\$449.00 / roll	\$399.00 / roll

Rubber Protectors



Rubber Column Guard

■ Size: 30(D) x 200(H) x 5000(L)mm

code	1-5	6+
21-RCG	\$145.00 / roll	\$125.00 / roll



Column Cushion

- Foam filled LDPE
- 2 halves with velcro straps
- Suits 5 different column diameters

code	description	1+
21-CC350-100	350mm outer, 100mm inner, 900mm high	\$825.00 / ea
21-CC350-150	350mm outer, 150mm inner, 900mm high	\$825.00 / ea
21-CC610-200	610mm outer, 200mm inner, 900mm high	\$1,288.00 / ea
21-CC610-250	610mm outer, 250mm inner, 900mm high	\$1,288.00 / ea
21-CC610-300	610mm outer, 300mm inner, 900mm high	\$1,288.00 / ea

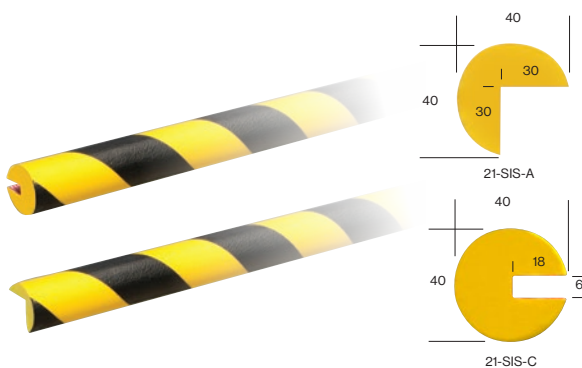

Safety Impact Strips

- Closed cell polyurethane foam
- Self adhesive backing
- 1000mm long

code	description	1-9	10+
21-SIS-A	Angle Profile	\$46.90 / ea	\$42.90 / ea
21-SIS-C	'C' Profile	\$46.90 / ea	\$42.90 / ea

Other Area Safe Categories



Carpark Protection



Signage & Safety

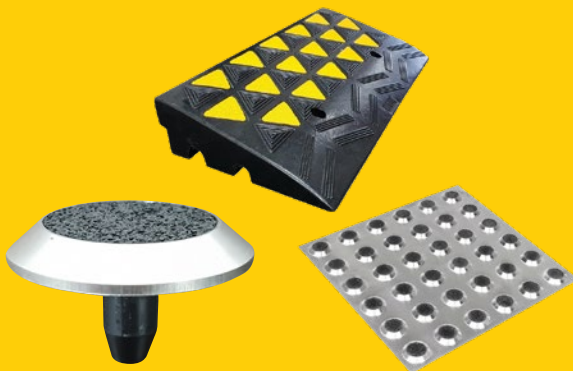

Matting Ramps & Tactiles

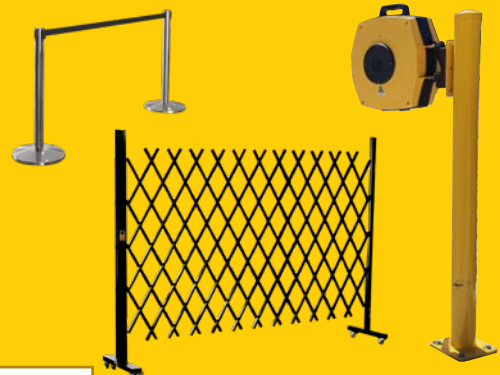

Pedestrian Barriers



www.areasafe.com.au



Email: sales@areasafe.com.au

Mail: PO Box 82, Plumpton NSW 2761

Address: 17 Sterling Road, Minchinbury NSW 2770

Hours: Open from 7:00am - 5:00pm, Monday to Friday