

Area Safe Car Park Products 2025

39



→ Customer Focused

→ Speedy Service

→ Innovative products



Car park Specialty Edition

March-May
Autumn 2025



phone 1300 889 821

Web www.areasafe.com.au
Email sales@areasafe.com.au

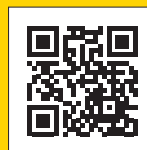

Why Choose Area Safe Products?

Customer Focused



Speedy Service



Innovative Designs



Create an Area Safe Products login to:

- View trade prices
- Download spec sheets, assembly guides, installation procedures and maintenance recommendations.

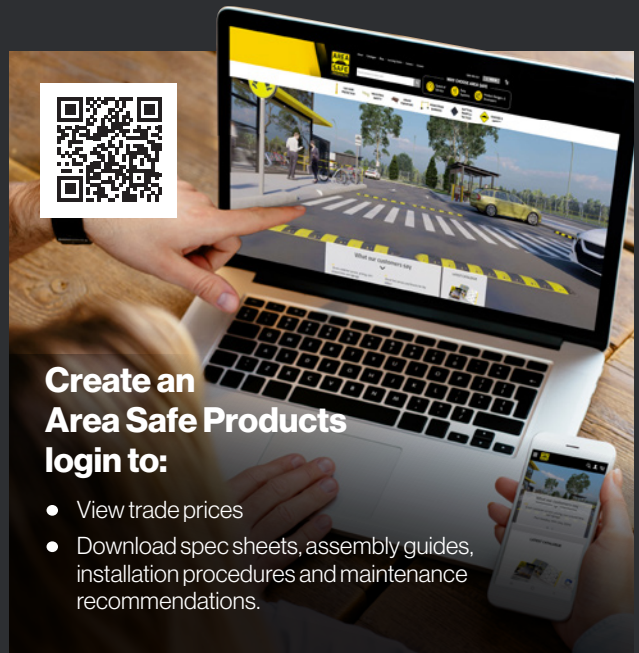

Contact us

Email: sales@areasafe.com.au
Web: www.areasafe.com.au
Mail: PO Box 82, Plumpton NSW 2761
Address: 17 Sterling Road, Minchinbury, NSW 2770
Open: 7:00am - 5:00pm, Monday-Friday
ABN: 74 114 414 185

The Area Safe Group



phone:
1300 889 821

All prices advertised through this catalogue exclude 10% GST. Design & prices subject to change without notice. E&OE © 2024 Area Safe Products Pty Ltd.



Car Wheel Stops	4	Convex Safety Mirrors	19
Truck and Large Vehicle Wheel Stops	5	Height Restriction Bars	20
Speed Humps	7	W-Beam Guard Rails Galvanised	21
Premium Steel Speed Humps	9	Downpipes Guards	22
Premium Bollards	11	Kerb Ramps	23
Bollards Base plate	12	Vehicle Cable Covers	24
Bollards In-ground	13	Tactile Indicators	25
Bollards Accessible Shared Zone	14	Speciality Products	26
Removable Bollards Key and Padlocked	15	Traffic Control	27
Parking Space Protectors	16	Sign Posts & Brackets	28
Impact Bollards	17	Traffic Signage	30
Impact Bollards / Flexible Traffic Separator	18	Parking Signs	31



Car Wheel Stops



Premium Rubber Wheel Stops



- Size: 1650(L) x 100(H) x 140(W)mm
- Weight: 14kg

✓ Complies with AS2890.1-2004

code	description	1-9	10-49	50-99	100+
07-WSRT	Rubber wheel stop black/yellow	\$82.90 / ea	\$67.90 / ea	\$59.90 / ea	\$54.90 / ea
07-WSRFC	Fasteners - into concrete M12 x 150mm Gal Screw Bolt (x3)	\$12.00 / set			
07-WSRFB	Fasteners - into bitumen M12 x 300mm gal with head (x3)	\$12.00 / set			



1.65m Precast Concrete Wheel Stops For Cars



- Size: 1650(L) x 90(H) x 190(W)mm
- Weight: 55Kg

✓ Complies with AS2890.1-2004

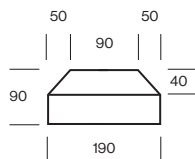

code	description	1-9	10-49	50+
07-WSC	Concrete wheel stop for cars	\$94.90 / ea	\$89.90 / ea	\$79.90 / ea
07-WSCF-C	Fasteners - into concrete M12 x 150 dowel (x2)	\$8.00 / set		
07-WSCF-B	Fasteners - into bitumen M12 x 300 gal with head (x2)	\$8.00 / set		

NEW

Wheel Stop / Kerb Signs

- Size: 60mm (H) x 600mm (W)
- Material: Metal
- Note: Pricing is only for signs



code	price
07-RPWSS	RESERVED PARKING \$59.90 / ea
07-SPWWS	STAFF PARKING \$59.90 / ea
07-CPOWSS	CUSTOMER PARKING ONLY \$59.90 / ea
07-CUSWWS	CUSTOM MESSAGE \$72.90 / ea

Truck and Large Vehicle Wheel Stops

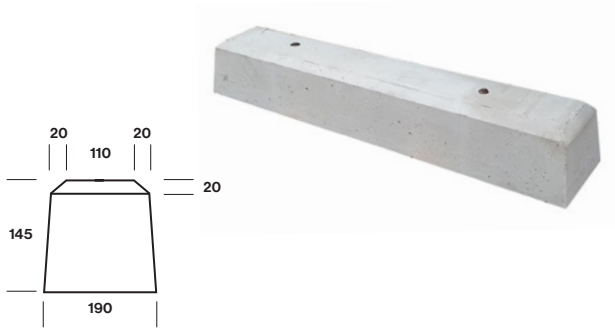

1m Precast Concrete Wheel Stops For Trucks & Equipment



- Size: 1000(L) x 190(W) x 145(H)mm
- Weight: 55Kg

code	description	1-9	10+
07-WSC-1	1m concrete wheel stops (2 Required per vehicle)	\$135.00 / ea	\$115.00 / ea
07-WSCF-C	Fasteners - into concrete M12 x 150 dowel (x2)	\$8.00 / set	
07-WSCF-B	Fasteners - into bitumen M12 x 300 gal with head (x2)	\$8.00 / set	

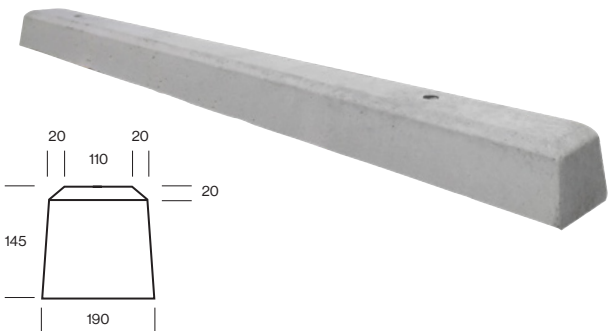

2m Precast Concrete Wheel Stops For Minibuses & Trucks



- Size: 2000(L) x 190(W) x 145(H)mm
- Weight: 110Kg

code	description	1-9	10+
07-WSC-2	2m concrete wheel stops	\$245.00 / ea	\$215.00 / ea
07-WSCF-C	Fasteners - into concrete M12 x 150 dowel (x2)	\$8.00 / set	
07-WSCF-B	Fasteners - into bitumen M12 x 300 gal with head (x2)	\$8.00 / set	

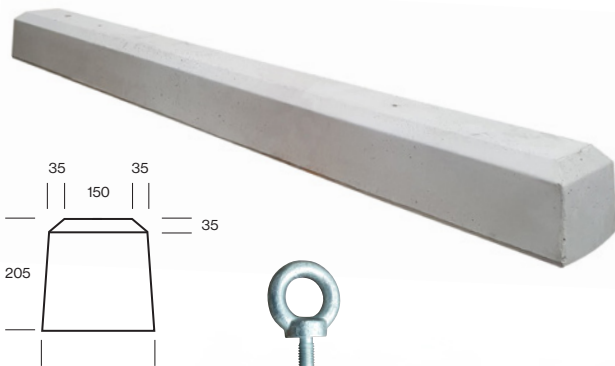

2.4m Precast Concrete Wheel Stops For Trucks



- Size: 2400(L) x 260(W) x 205(H)mm
- Weight: 260kg

code	description	1-9	10+
07-TWSC	Concrete wheel stop for trucks	\$349.00 / ea	\$319.00 / ea
07-TWSCF	Heavy Duty Steel Rod for fixing - M20 x 400mm (x2)	\$59.90 / set	
07-WSCF-B	Light Duty Positioning Pin - M12 x 300mm (x2)	\$8.00 / set	
07-EB12	M12 lifting eye bolts (2 required)	\$19.90 / ea	

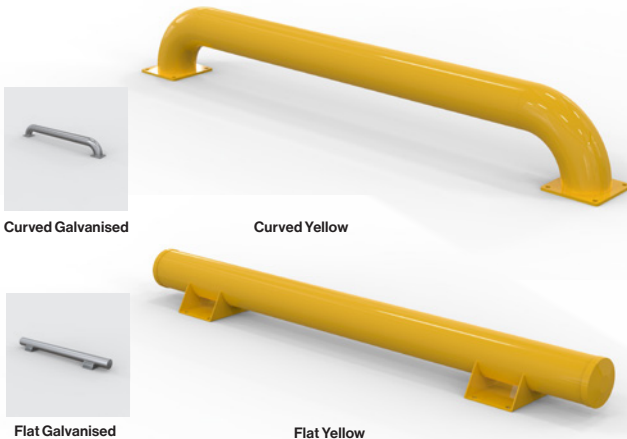

NEW

Galvanised Steel Wheel Stops For Trucks



- Curved Size: 2303(L) x 220(W) x 311(H)mm (Diameter 165mm)
- Flat Size: 2205(L) x 300(W) x 202(H)mm (Diameter 165mm)

code	description	1+
07-STWSC-Y	Curved steel wheel stop for trucks - Yellow	\$1595.00 / ea
07-STWSC-G	Curved steel wheel stop for trucks - Galvanised	\$1495.00 / ea
07-STWSF-Y	Flat steel wheel stop for trucks - Yellow	\$929.00 / ea
07-STWSF-G	Flat steel wheel stop for trucks - Galvanised	\$899.00 / ea
08-GBM16110	Galvanised M16x110mm Sleeve Anchor with Washer (8 required per wheel stop)	\$4.20 / ea

Rubber Speed Hump Features

1. UV resistant for colour consistency
2. 'Easy ride' profile
3. Inset reflectors for night visibility
4. Flexi Rubber for uneven surfaces
5. Heavy Duty

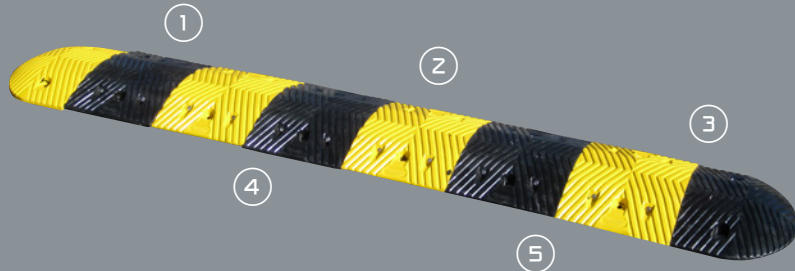

Plastic Speed Hump Features

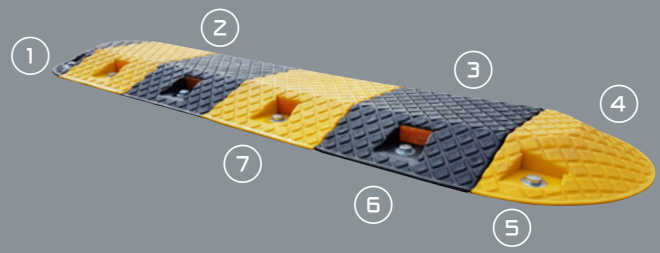

1. Recycleable HDPE
2. 100% Australian Standard Compliant
3. Heavy duty moulded plastic construction
4. Reinforced honeycomb core
5. Concealed fixing points
6. Inset reflectors for night visibility
7. Flat sides for effective speed control



Speed Humps

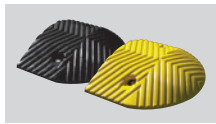

End Cap Modules

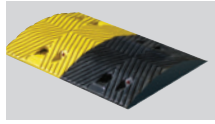

Centre Module

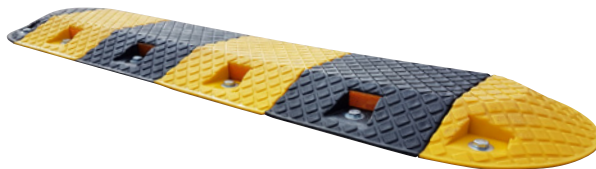

End Cap Modules

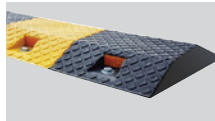

Centre Modules

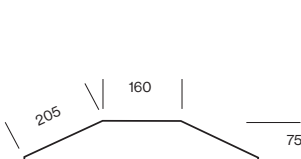
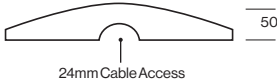
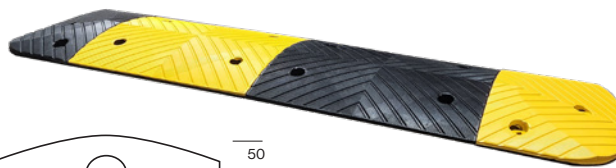

Heavy Duty Solid Rubber Speed Hump For Cars & Trucks



- Material: Solid heavy duty rubber/PVC combination
- Size: 500(L)mm x 350(W)mm
- Weight 15kg per metre

code	description	1-9	10+	30+
03-HSD500	Black/yellow module (2 per metre) 500(L) x 350(W) x 50(H)mm	\$119.00 / mtr	\$99.00 / mtr	\$85.00 / mtr
03-HSD5E	End cap set (Set/2) 250(L) x 350(W) x 50(H)mm	\$69.00 / set		
03-HERFC	Fasteners - concrete M12 x 65 D Bolts	\$12.90 / mtr		
03-HERFB	Fasteners - bitumen M14 x 75 Plug/CS	\$12.90 / mtr		
28-SBS	Sealant Adhesive 600ml	\$33.90 / ea		

Heavy Duty Plastic Speed Hump For Cars & Trucks



- Material: Tough UV stabilised HDPE plastic
- End caps: 170(L) x 350(w) x 50(H)mm
- Modules: 250(L) x 350(W) x 50(H)mm
- Weight: 7kg per metre

code	description	1-9	10+	30+
02-HPC	Black/yellow module (Minimum order 1m)	\$119.00 / mtr	\$99.00 / mtr	\$85.00 / mtr
02-HPCE	End cap set (Set/2)	\$69.00 / set		
02-HPCF	Fasteners M14 x 75 Plug/CS (Minimum order 1m)	\$12.90 / mtr		
28-SBS	Sealant Adhesive 600ml	\$33.90 / ea		

✓ Complies with AS2890.1-2004

Heavy Vehicle Recycled Rubber Speed Hump 50mm for Trucks



- Material: Heavy duty recycled rubber
- Weight: 15kg per metre
- Modules: 500(L) x 420(W) x 50(H)mm
- Cable channel underneath
- End Caps: 220(L) x 420(W) x 50(H)mm

code	description	1+
05-HRR5	Black/yellow modules	\$159.00 / mtr
05-HRR5E	End cap set (Set/2)	\$99.00 / set
05-HRF75FC	Fasteners to suit concrete M12 x 80 D Bolts	\$12.90 / mtr
05-HRRFB	Fasteners to suit bitumen M14 x 75 Plug/CS	\$12.90 / mtr
28-SBS	Sealant Adhesive 600ml	\$33.90 / ea

Heavy Vehicle Recycled Rubber Speed Hump 75mm for Trucks

- Material: Heavy duty recycled rubber
- End Caps: 250(L) x 550(W) x 75(H)mm
- Module: 500(L) x 550(W) x 75(H)mm
- Weight: 30kg per metre

code	description	1+
03-HRF75	Black/yellow modules	\$199.00 / mtr
03-HRF75E	End cap set (Set/2)	\$125.00 / set
03-HRF75FC	Fasteners to suit concrete M12 x 80 D Bolts	\$12.90 / mtr
03-HRRFB75	Fasteners to suit bitumen M14 x 75 Plug/CS	\$12.90 / mtr
28-SBS	Sealant Adhesive 600ml	\$33.90 / ea



Premium Steel Speed Hump Features

1. Heavy 5mm Wall thickness
2. Stronger Flanged mounting points
3. 100% Australian standard compliant
4. Powder Coated Black Sections (not sprayed over)
5. Powder Coated Yellow Sections
6. Large cable channel
7. Double reinforcing gussets
8. Individual 1m modules
9. Flush gussets prevent leverage on fixings
10. Cable channel
11. Wider footprint makes more secure fixings

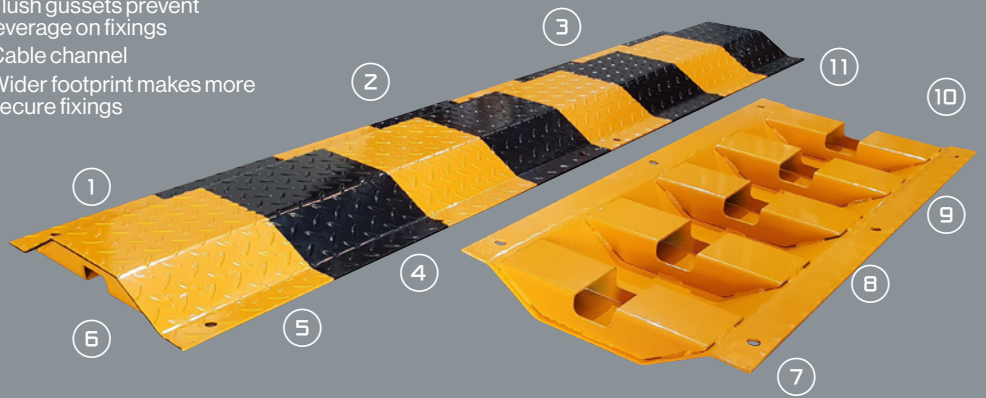

Steel Speed Hump - 5mm Plate



Steel Speed Hump - 3mm Plate



Steel Speed Hump - 3mm Plate



Premium Steel Speed Humps



Steel Speed Hump 3mm Plate

- Material: 3mm steel plate
- Treatment: Hot-dipped galvanised
- Finish: Powdercoated checker plate
- Modules: 1000(L) x 450(W) x 60(H)mm
- End caps: 210(L) x 343(W) x 56(H)mm
- Weight: 19kg per metre
- Cable channel: 30(H) x 65(W)mm

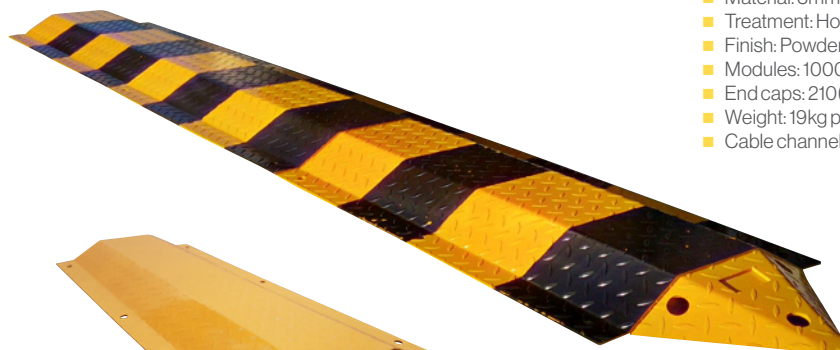

02-SMWY
Plain Yellow Option



02-SMWE
End Cap Modules

✓ Complies with AS2890.1-2004

code	description	1-9	10+
02-SMW	Black & Yellow Module - 1m	\$277.00 / mtr	\$245.00 / mtr
02-SMWY	Plain Yellow Module - 1m (DISCONTINUED LINE - PRICE TO CLEAR STOCK)	\$149.00 / mtr	
02-SMWE	Steel End Cap (Set/2)	\$149.00 / set	
02-HMFC	Fasteners - concrete	\$12.90 / mtr	
02-HMFB	Fasteners - bitumen	\$12.90 / mtr	
28-SBS	Sealant Adhesive 600ml	\$33.90 / ea	

Steel Speed Hump 5mm Plate

- Material: 5mm steel plate
- Treatment: Hot-dipped galvanised
- Finish: Powdercoated checker plate
- Modules: 1000(L) x 450(W) x 60(H)mm
- End caps: 210(L) x 343(W) x 56(H)mm
- Weight: 26kg per metre
- Cable channel: 30(H) x 65(W)mm



02-HMWE
End Cap Modules

✓ Complies with AS2890.1-2004

code	description	1-9	10+
02-HMW	Heavy Duty Module - 1m (Black/Yellow)	\$349.00 / mtr	\$319.00 / mtr
02-HMWE	Steel End Cap (Set/2)	\$149.00 / set	
02-HMFC	Fasteners - concrete	\$12.90 / mtr	
02-HMFB	Fasteners - bitumen	\$12.90 / mtr	
28-SBS	Sealant Adhesive 600ml	\$33.90 / ea	



Fixed Steel Bollards - Yellow - In-ground - 90mm



Fixed Steel Bollards - White Satin - In-ground - 140mm



Fixed Steel Bollards - Yellow - Base Plate - 140mm



Steel Bollards - Galvanised - Base Plate - 140mm



Fixed Steel Bollard - Yellow - In-ground - 220mm



Premium Bollards

Area Safe steel bollards are essential for separating pedestrians from vehicles and for protecting property. Bollards are a legal requirement for accessible parking shared zones and for preventing obstruction of fire egress doors. Standard powder coat colour is safety yellow — other colours made to order (please enquire).



- **Optional chain rings available**
- **Standard colour is safety yellow**
- **Other colours available - See pages 18-19**
- **Custom bollards - POA**

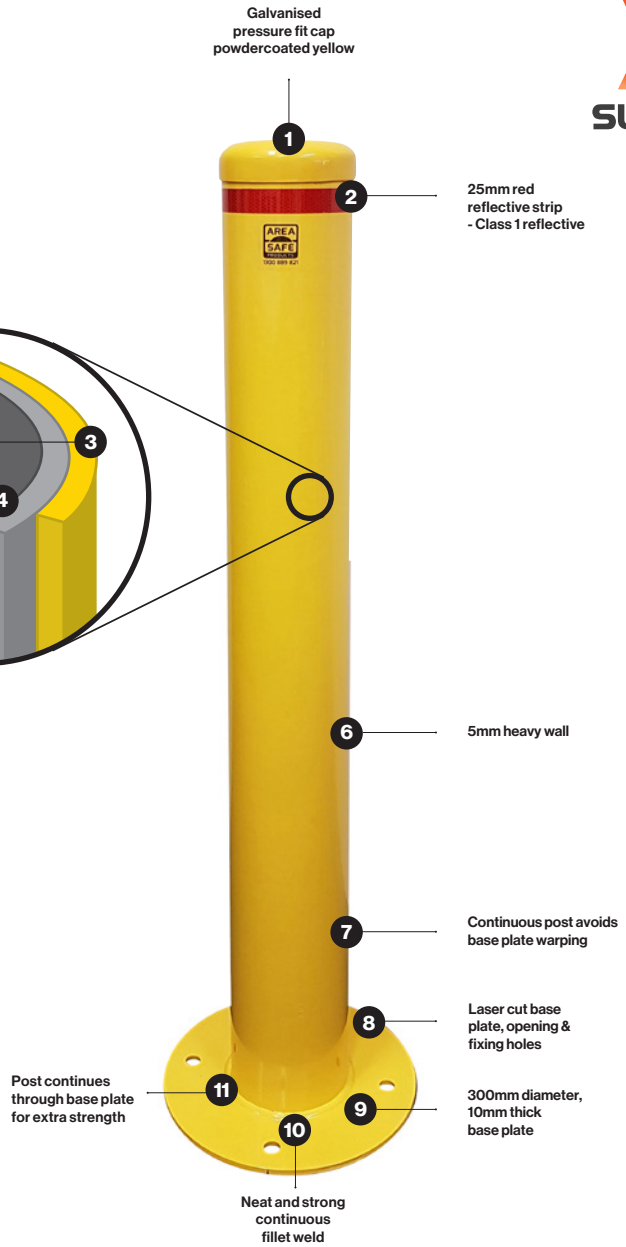
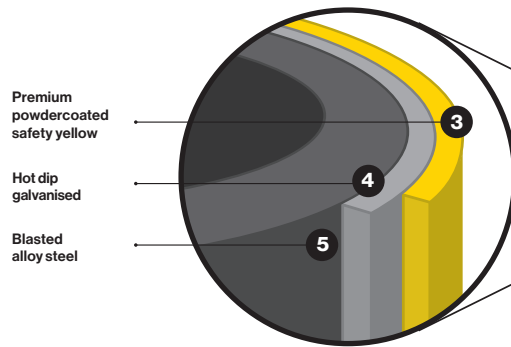

Area Safe Premium Bollards		
✓	Galvanised pressure fit cap powdercoated yellow	1
✓	25mm red reflective Strip - class 1 reflective	2
✓	Premium powdercoated Safety yellow, gloss	3
✓	Hot dip galvanised	4
✓	Blasted alloy steel	5
✓	5mm heavy wall	6
✓	Continuous post avoids base plate warping	7
✓	Laser cut base plate, Opening & fixing holes	8
✓	300mm diameter, 10mm thick base plate	9
✓	Neat and strong 3mm CFW electronic weld	10
✓	Post continues through base plate for extra strength	11



Bollards Base plate



Fixed Steel Bollards Yellow (Base Plate)

code	description	1-10	11-25	26+
08-SF75BP	Fixed Base Plate Bollard (Round base plate & Black Plastic Cap) 3mm Wall - Ø75 x 900(H)mm - 8kg	\$142.90 / ea	\$118.90 / ea	\$POA
08-SF90BP	Fixed Base Plate Bollard (Round base plate), 5mm Wall - Ø90 x 900(H)mm - 10kg	\$194.90 / ea	\$176.90 / ea	\$POA
08-SF115BP	Fixed Base Plate Bollard (DDA - Round base plate) 3mm Wall - Ø115 x 1300(H)mm - 12kg	\$219.90 / ea	\$199.90 / ea	\$POA
08-SF140BP	Fixed Base Plate Bollard (Round base plate) 5mm Wall - Ø140 x 1200(H)mm - 25kg	\$299.00 / ea	\$286.00 / ea	\$POA
09-SF165BP	Fixed Base Plate Bollard (Square base plate) 5mm Wall - Ø165 x 1200(H)mm - 30kg	\$369.00 / ea	\$349.00 / ea	\$POA
09-SF220BP	Fixed Base Plate Bollard (Round base plate) 5mm Wall - Ø220 x 1200(H)mm - 50kg	\$729.00 / ea		
08-GSB1275X4	M12 x 75mm Galvanised Screw Bolt - Set of 4 (Suits 75mm, 90mm, 115mm Bollards)	\$9.90 / set		NEW
08-GSB16100X4	M16 x 100mm Galvanised Screw Bolt - Set of 4 (Suits 140mm, 165mm, 220mm Bollards - 220mm require 5 bolts)	\$23.90 / set		NEW

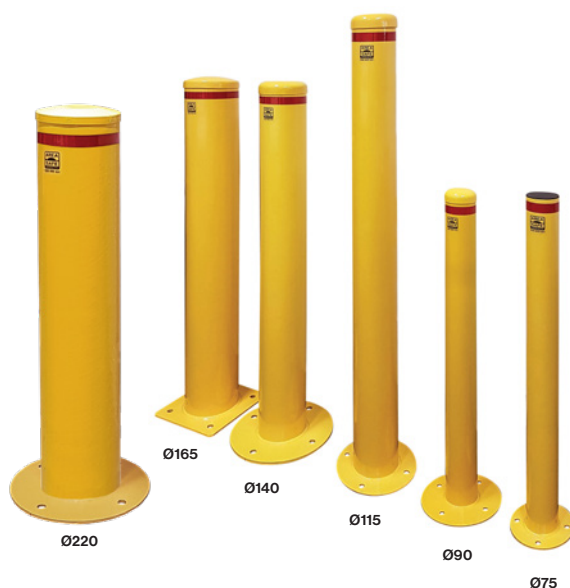

Fixed Steel Bollards Black (Base Plate)

- Made to order - lead time applies
- Other colours available - please enquire
- Red reflective tape is supplied loose



code	description	1+
08-BL90BP	Fixed Base Plate Bollard (Round base plate) 5mm Wall - Ø90 x 900(H)mm - 10kg	\$209.90 / ea
08-BL115BP	Fixed Base Plate Bollard (Round Base Plate) 3mm Wall - Ø115 x 1300(H)mm - 12kg	NEW \$299.00 / ea
08-BL140BP	Fixed Base Plate Bollard (Round base plate) 3mm Wall - Ø140 x 1200(H)mm - 25kg	\$319.00 / ea
09-BL165BP	Fixed Base Plate Bollard (Square base plate) 5mm Wall - Ø165 x 1200(H)mm - 30kg	\$385.00 / ea
08-GSB1275X4	M12 x 75mm Galvanised Screw Bolt - Set of 4 (Suits 90mm, 115mm Bollards)	NEW \$9.90 / Set
08-GSB16100X4	M16 x 100mm Galvanised Screw Bolt - Set of 4 (Suits 140mm, 165mm Bollards)	NEW \$23.90 / Set



Fixed Steel Bollards Custom Colour (Base Plate)

- Pricing below applicable to below colours only (other colours available \$POA)



	Charcoal		Notre Dame		Signal Red
	Monument		Apo Grey		Blaze Blue
	Anotec Dark Grey		White Satin		Mistletoe
	Woodland Grey		Orange X15		

code	description	1-4	5+
08-CB90BP-COLOUR	Fixed Base Plate Bollard (Round base plate) 5mm Wall - Ø90 x 900(H)mm - 10kg	\$325.00 / ea	\$249.00 / ea
08-CB115BP-COLOUR	Fixed Base Plate Bollard (Round Base Plate) 3mm Wall - Ø115 x 1300(H)mm - 12kg	\$359.00 / ea	\$299.00 / ea
08-CB140BP-COLOUR	Fixed Base Plate Bollard (Round base plate) 5mm Wall - Ø140 x 1200(H)mm - 25kg	\$465.00 / ea	\$359.00 / ea
09-CB165BP-COLOUR	Fixed Base Plate Bollard (Square base plate) 5mm Wall - Ø165 x 1200(H)mm - 30kg	\$510.00 / ea	\$395.00 / ea
08-GSB1275X4	M12 x 75mm Galvanised Screw Bolt - Set of 4, (Suits 90mm, 115mm Bollards)	\$9.90 / set	
08-GSB16100X4	M16 x 100mm Galvanised Screw Bolt - Set of 4 (Suits 140mm, 165mm Bollards)	\$23.90 / set	

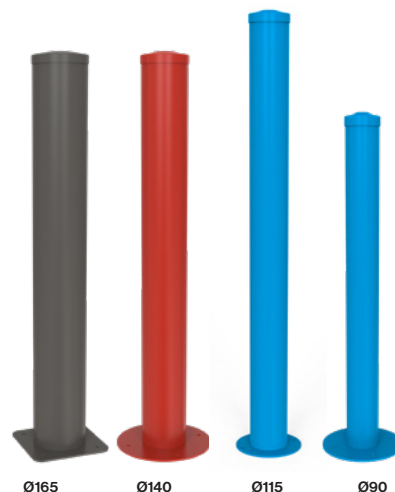

Bollards In-ground

Fixed Steel Bollards Yellow (In-ground)



- Caps and reflective tape supplied loose

code	description	1-10	11-25	26+
08-SF90IG	Fixed In-ground Bollard 5mm Wall - Ø90 x 1300(H)mm(Overall) - 13kg	\$219.90 / ea	\$194.90 / ea	\$POA
08-SF115IG	Fixed In-ground Bollard 5mm Wall - Ø115 x 1625(H)mm (Overall) - 13kg	\$219.00 / ea	NEW	
08-SF140IG	Fixed In-ground Bollard 5mm Wall - Ø140 x 1625(H)mm(Overall) - 30kg	\$329.00 / ea	\$309.00 / ea	\$POA
09-SF165IG	Fixed In-ground Bollard 5mm Wall - Ø165 x 1625(H)mm(Overall) - 35kg	\$399.00 / ea	\$382.00 / ea	\$POA
09-SF220IG	Fixed In-ground Bollard 5mm Wall - Ø220 x 1800(H)mm(Overall) - 50kg	\$POA		



Fixed Steel Bollards Black (In-ground)



- Made to order — lead time applies
- Other colours available — please enquire
- Caps and reflective tape supplied loose

code	description	1+
08-BL90IG	Fixed In-ground Bollard 5mm Wall - Ø90 x 1300(H)mm(Overall) - 13kg	\$232.00 / ea
08-BL115IG	Fixed In-ground Bollard 5mm Wall - Ø115 x 1625(H)mm (Overall) - 13kg	NEW \$299.00 / ea
08-BL140IG	Fixed In-ground Bollard 5mm Wall - Ø140 x 1625(H)mm(Overall) - 30kg	\$355.00 / ea
09-BL165IG	Fixed In-ground Bollard 5mm Wall - Ø165 x 1625(H)mm(Overall) - 35kg	\$429.00 / ea



Fixed Steel Bollards Custom Colour (In-ground)



- Pricing below applicable to below colours only (other colours available \$POA)

	Charcoal		Apo Grey		Mistletoe
	Monument		White Satin		
	Anotec Dark Grey		Orange X15		
	Woodland Grey		Signal Red		
	Notre Dame		Blaze Blue		

code	description	1 - 4	5+
08-CB90IG-COLOUR	Fixed In-ground Bollard - Custom Colour 5mm Wall - Ø90 x 1300(H)mm(Overall) - 13kg	\$359.00 / ea	\$275.00 / ea
08-CB115IG-COLOUR	Fixed Base Plate Bollard (Round Base Plate) 5mm Wall - Ø115 x 1625(H)mm - 13kg	NEW \$389.00 / ea	\$299.00 / ea
08-CB140IG-COLOUR	Fixed In-ground Bollard 5mm Wall - Ø140 x 1625(H)mm(Overall) - 30kg	\$515.00 / ea	\$395.00 / ea
09-CB165IG-COLOUR	Fixed In-ground Bollard 5mm Wall - Ø165 x 1625(H)mm(Overall) - 35kg	\$595.00 / ea	\$469.00 / ea

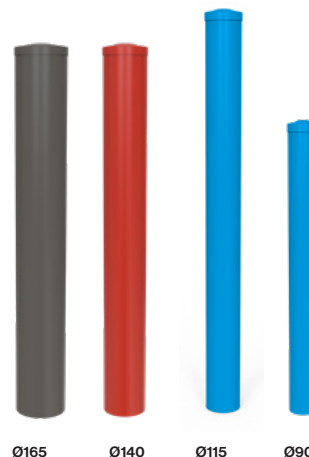

Bollards Accessible Shared Zone



NEW

Shared Zone Bollards Base Plate

- Compliant 1300mm High
- Compliant 300mm Wide Red Reflective Strip (supplied loose)
- Colours: Yellow, Black, Blue or Plain Galvanised
- Diameter: 115mm

code	description	price
08-SF115BP-SZ	Yellow	\$259.90 / ea
08-BL115BP-SZ	Black	\$339.00 / ea
08-CB115BP-BLU-SZ	Blue	\$339.00 / ea
08-B115BP-SZ	Plain Galvanised	\$238.00 / ea
08-GSB1275X4	M12 x 75mm Galvanised Screw Bolt - Set of 4	\$9.90 / Set

✓ New Parking Australian Standards AS2890.6:2022 affect Shared Zone Bollards - Area Safe Bollards now compliant!



NEW

Shared Zone Bollards In-ground

- Compliant 1300mm High (Overall height 1625mm)
- Compliant 300mm High Red Reflective Strip (supplied loose)
- Colours: Yellow, Black, Blue or Plain Galvanised
- Diameter: 115mm

code	description	price
08-SF115IG-SZ	Yellow	\$259.00 / ea
08-BL115IG-SZ	Black	\$339.00 / ea
08-CB115IG-BLU-SZ	Blue	\$339.00 / ea
08-B115IG-SZ	Plain Galvanised	\$238.00 / ea

✓ New Parking Australian Standards AS2890.6:2022 affect Shared Zone Bollards - Area Safe Bollards now compliant!



NEW

Compliant Shared Zone Bollard Reflective

- Reflective Strip to apply to old or existing bollards
- 300(H) x 450(W)mm - Suits up to 140mm diameter bollards
- Red Microprismatic Retroreflective sheet

code	description	price
08-SZBR300	300(H) x 450(W)mm	\$39.90 / ea

✓ New Parking Australian Standards AS2890.6:2022 affect Shared Zone Bollards - Area Safe Bollards now compliant!

Removable Bollards Key and Padlocked

Key Operated Surface Mount Removable Bollard Yellow

- Bollard: Ø90 x 1020(H)mm
- Receiver Shoe: 200(W) x 18(H)mm
- Weight: 14kg



Storage Shoe

code	description	1-4	5+
09-SRSMK	Bollard & Receiver Shoe	\$319.00 / ea	\$299.00 / ea
09-SRSMK-B	Storage Shoe - Yellow	\$98.00 / ea	
09-FHSA	M12 x 65 Flush Head anchors (Set of 4)	\$9.00 / set	

Padlock Secured In-ground Removable Bollards 90mm - Galvanised

- Bollard: Ø90 x 950(H)mm (above ground)
- Weight: 12kg bollard + 3kg sleeve

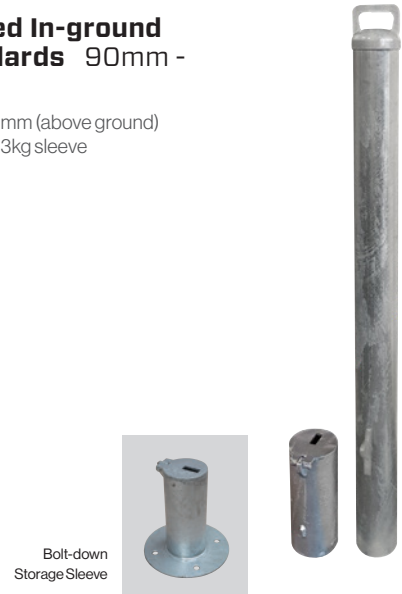

Bolt-down Storage Sleeve

code	description	1-4	5+
09-SRP90-G	Bollard & Sleeve (Gal Finish)	\$279.00 / ea	\$249.00 / ea
09-SRK90-BDS	Bolt-down Storage Sleeve	\$149.00 / ea	

Key Operated In-ground Removable Bollard 140mm

- Bollard: Ø140 x 950(H)mm (Overall length: 1150mm)
- Weight: 18kg bollard + 6kg sleeve



Bolt-down Storage Sleeve

code	description	1-4	5+
09-SRK140	Bollard & Sleeve	\$499.00 / ea	\$455.00 / ea
09-SRK140-BDS	Bolt-down Storage Sleeve	\$199.00 / ea	

Padlock Secured In-ground Removable Bollards 90mm - Black

- Bollard: Ø90 x 950(H)mm (above ground)
- Weight: 12kg bollard + 3kg sleeve

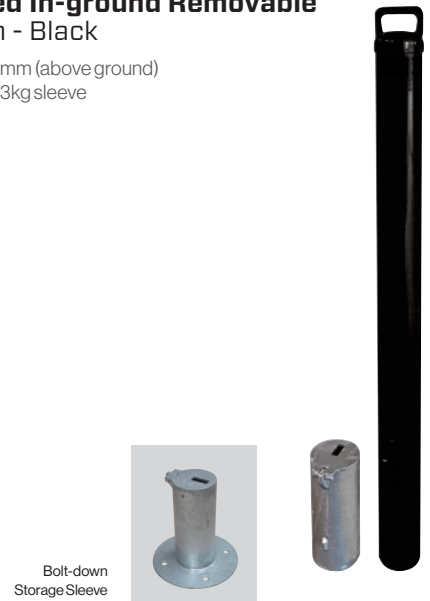

Bolt-down Storage Sleeve

code	description	1-4	5+
09-SRP90-BK	Bollard & Sleeve (Black)	\$349.00 / ea	\$319.00
09-SRK90-BDS	Bolt-down Storage Sleeve	\$149.00 / ea	

Parking Space Protectors

Key Operated Parking Space Protector Round

- Height: 670mm / 85mm
- Post: Ø60mm
- All keyed alike
- Weight: 6kg



code	1-5	6+
16-KOSP-R	\$219.00 / ea	\$189.00 / ea



Heavy Duty Pivoted Base Plate Bollard / Space Protector

- Height: 800mm / 102mm
- Post: 90 x 90mm
- Wall: 5mm
- Weight: 10kg

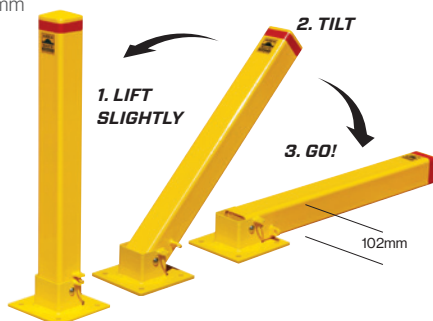

code	1-5	6+
09-SPBP	\$299.00 / ea	\$269.00 / ea
08-GSB1275X4	M12x75mm Galvanised Screw Bolt - Set of 4 \$9.90 / Set	

Plate Parking Space Protectors

- Locked up: 750(H) x 300(W)mm
- Locked flat: 35mm low
- Reflective Sign: No Parking



• No Entry signs also available - please enquire.

code	price
16-SPSP-F	\$625.00 / ea

Padlock Secured Space Protector Traditional Style

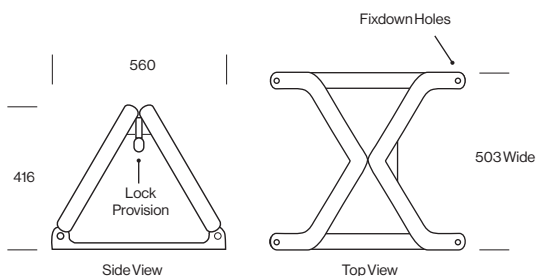

code	1-5	6-10	11+
16-SMK	\$349.00 / ea	\$319.00 / ea	\$299.00 / ea

Impact Bollards



Heavy Duty Plastic Impact Bollards

- 10mm wall thickness
- Flexes slightly on impact

code	description	1+
09-SP90BP-B	Ø90 x 1000 (H) - Black	\$259.00 / ea
09-SP90BP-Y	Ø90 x 1000 (H) - Yellow	\$259.00 / ea
09-SP140BP-Y	Ø140 x 1200 (H) - Yellow	\$519.00 / ea

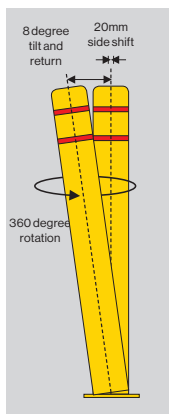

Shock Absorbing Bollards Surface Mounted

- Engineered to tilt and return to vertical
- Bollard: Ø160 x 1330(H)mm
- Base: Ø350mm

code		1+
09-SAB140BP		\$1,390.00 / ea
08-GSB16100X4	M16 x 100mm Galvanised Screw Bolt - Set of 4	\$23.90 / Set

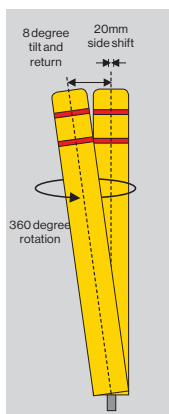

Shock Absorbing Bollards Core Drilled

- Engineered to tilt and return to vertical
- Bollard: Ø160 x 1330(H)mm
- In-ground shaft: Ø50mm x 300(L)mm

code		1+
09-SAB140CD		\$998.00 / ea

Impact Bollards / Flexible Traffic Separator



One-Piece Flexible Bollards

- Durable one piece moulded robust plastic (PU)
- Rebounds after impact
- Can be completely run over

code	description	1-9	10+
15-OPF45R	Ø80 x 450(H)mm - Base: Ø205mm	\$59.90 / ea	\$55.90 / ea
15-OPF75	Ø80 x 750(H)mm - Base: Ø205mm	\$74.90 / ea	\$68.50 / ea



Lane Master Bollards

- Bollard: 100(D) x 490(H)mm
- Insert: 38(D) x 200(H)mm

code	description	1-24	25+
22-CSLMB	Lane Master Bollard	\$54.90 / ea	\$44.50 / ea
22-CSLMI	In-ground Insert	\$26.60 / ea	\$23.90 / ea

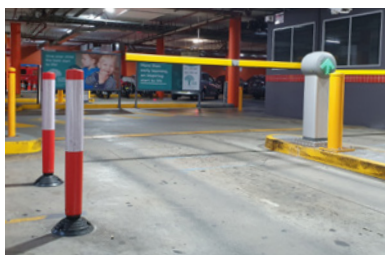

Impact Recovery Bollards

- Knock down bollards with elasticised joint
- Complete 2 piece base and post
- Post twist locks into rubber base
- Not designed to be completely run over
- Size: 1000(H)mm

Note: Reflective band pattern may vary.

code	1-9	10+
15-KDB10	\$99.50 / ea	\$88.90 / ea

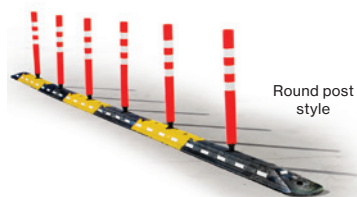
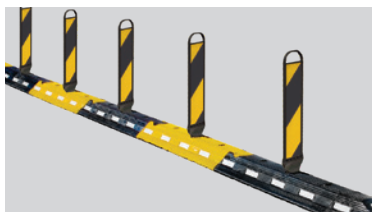

Round post style



Panel post style

Flexible Traffic Separator

- Centre module: 1000(L) x 250(W) x 80(H)mm
- End cap: 500(L) x 250(W) x 80(H)mm
- Round Post: 900(H)mm
- Panel Post: 750(H)mm

code	description	1-29	30+
03-FTS	1m Centre Modules	\$99.00 / ea	\$89.00 / ea
03-FTS-E	End Cap Set (2 modules/set)	\$119.00 / set	
03-FTS-P	Round Post (1 post required/1mtr centre module)	\$24.00 / ea	
03-FTS-PF	Panel Post - Flat (1 panel required/1mtr centre module)	\$24.00 / ea	
03-FTS-FC	Fasteners - into concrete 150mm C/Screw + Plug (x2)	\$8.00 / set	
03-FTS-FB	Fasteners - into bitumen/roadbase M12 x 300mm Gal with head (x2)	\$6.00 / set	

Convex Safety Mirrors



Outdoor Convex Mirrors

- Heavy duty polycarbonate
- Brackets suit wall or post mounting

code	description	1+
18-TRAF450	450mm Mirror (60mm Post Bracket)	\$199.00 / ea
18-TRAF600	600mm Mirror (60mm Post Bracket)	\$239.00 / ea
18-TRAF800	800mm Mirror (75mm Post Bracket)	\$349.00 / ea
18-TRAF1000	1000mm Mirror (75mm Post Bracket)	\$495.00 / ea



Indoor Convex Mirrors

- Heavy duty polycarbonate
- Brackets suit wall or post mounting

code	description	1+
18-IN450D	450mm Mirror (60mm Post Bracket)	\$139.00 / ea
18-IN600D	600mm Mirror (60mm Post Bracket)	\$199.00 / ea
18-IN760D	800mm Mirror (75mm Post Bracket)	\$289.00 / ea



Stainless Steel Convex Traffic Mirrors

- Brackets included to fit 75mm posts
- Brackets suit wall or post mounting

code	description	1+
18-SS600V	600mm Stainless Steel Mirror	\$619.00 / ea
18-SS800V	800mm Stainless Steel Mirror	\$725.00 / ea
18-SS1000V	1000mm Stainless Steel Mirror	\$998.00 / ea
18-SSWMB	Wall Mount Bracket	\$85.00 / ea



Height Restriction Bars



Standard 1m Height Bar Design



Standard Height Bar Design for 2m-6m sizes



Height Restriction Bars

- Height labels in stock: 1.8m, 1.9m, 2.0m, 2.1m, 2.2m, 2.3m, 2.4m
- Specify clearance height when ordering

✓ Custom height bars available - please enquire

code	description	1+
12-HRB1	Yellow Height Bar - 1m long	\$339.00 / ea
12-HRB2	Yellow Height Bar - 2m long	\$449.00 / ea
12-HRB3	Yellow Height Bar - 3m long	\$498.00 / ea
12-HRB4	Yellow Height Bar - 4m long	\$598.00 / ea
12-HRB5	Yellow Height Bar - 5m long	\$770.00 / ea
12-HRB6	Yellow Height Bar - 6m long	\$759.00 / ea

1m, 2m, 3m and 4m height bars also available in white and black.

Additional \$50/metre for black or white height bars - add to above pricing

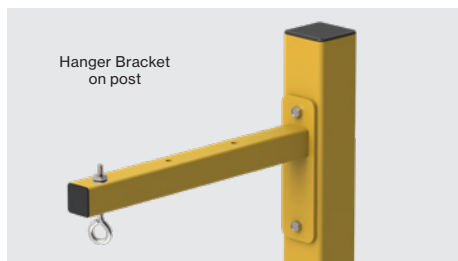

Hanger Bracket on post



Surface Mount

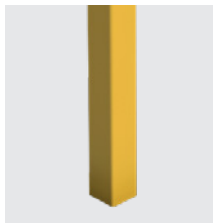

In-ground

Height Bar Supports

- Surface mounted post
- In-ground post
- Wall mounting bracket

code	description	1+
12-HRB-SOB	Adjustable Hanger Bracket - 500mm long & chain ring	\$175.00 / ea
12-HRB-SMP	Surface Mounted Post - 3000(H) x 89 x 89 x 4mm	\$719.00 / ea
12-HRB-IGP	In-ground Post - 4000(H) x 89 x 89 x 4mm	\$689.00 / ea
08-GSB16100X4	M16 x 100mm Galvanised Screw Bolt - Set of 4	\$23.90 / Set

Height Warning Signs

- White background with black text
- For fascias & bulkheads
- Specify clearance height when ordering
- Material: Metal

✓ Custom signs available - please enquire

code	size	1+
14-HRS212	1200(W) x 200(H)mm	\$99.00 / ea
14-HRS16	600(W) x 125(H)mm	\$69.00 / ea



14-HRS212



14-HRS16

W-Beam Guard Rails - Galvanised

NEW

W-Beam Guard Rails Galvanised

- Galvanised finish

code	description	1+
12-WBR1	1m - W-Beam Rail (use 2 posts)	\$125.00 / ea
12-WBR2	2m - W-Beam Rail (use 2 posts)	\$249.00 / ea
12-WBR4	4m - W-Beam Rail (use 3 posts)	\$385.00 / ea
12-WB-SB	Splice Bolt/Nut (use 8 per join)	\$5.40 / ea

NEW

W-Beam Posts Galvanised

- Galvanised finish
- 1 Person install design
- Handle for easier carrying
- W-Beam Holder Bracket for easier installation

code	description	1+
12-WBCP	680mm - C-Post, Surface Mount	\$215.00 / ea
12-WBCP-D	1140mm - C-Post, Surface Mount (double height)	\$329.00 / ea
12-WBCPIG	1225mm - C-Post, In-ground	\$289.00 / ea
12-WBCPIG-D	1850mm - C-Post, In-ground (double height)	\$329.00 / ea
12-WB-PB	Post Bolt/Nut	\$5.40 / ea
12-WBPF1	Fasteners to suit Standard Height W-Beam Post M20x160mm Galvanised Through Bolt	\$10.00 / ea
12-WBPF2	Fasteners to suit Double Height W-Beam Post M20x160mm Galvanised Through Bolt (Set of 2)	\$20.00 / set

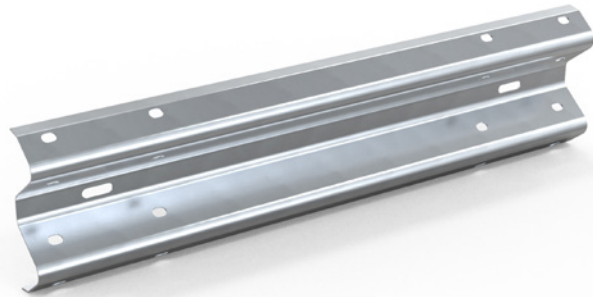

725mm

Terminal Options

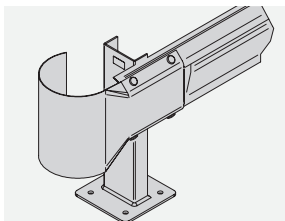

CarPark C-End

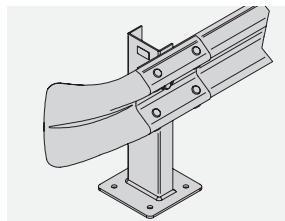

Fish Tail

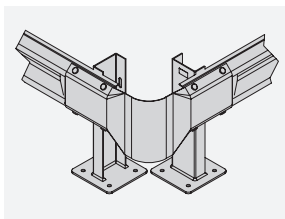

External Corner

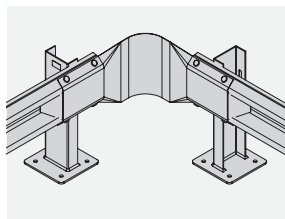

Internal Corner

NEW

W-Beam Terminals Galvanised

- Galvanised finish

code	description	1+
12-WBCE	Car Park C-End, Gal (use 4 splice bolts)	\$189.00 / ea
12-WBFT	Fish Tail - Gal (use 8 splice bolts)	\$189.00 / ea
12-WBFCE	90° Corner - External, Gal (use 8 splice bolts total)	\$365.00 / ea
12-WBFCEI	90° Corner - Internal, Gal (use 8 splice bolts total)	\$365.00 / ea
12-WB-SB	Splice Bolt/Nut	\$5.40 / ea

Downpipe Guards



Galvanised Steel Downpipe Protectors

- Industrial 2mm thickness (3mm available - please enquire)
- Galvanised
- Side flanges 50mm wide
- Pre-drilled Ø14 fixing holes

code	description	1+
21-GDP150	150(W) x 150(D) x 1200(H) x 2mm	\$179.00 / ea
21-GDP200	200(W) x 200(D) x 1200(H) x 2mm	\$199.00 / ea
21-GDP250	250(W) x 250(D) x 1200(H) x 2mm	\$225.00 / ea



Yellow Downpipe Protectors

- Industrial 2mm thickness (3mm available - please enquire)
- powder coat Safety Yellow
- Side flanges 50mm wide
- Pre-drilled Ø14 fixing holes

code	description	1+
21-GDP150-Y	150(W) x 150(D) x 1200(H) x 2mm	\$288.00 / ea
21-GDP200-Y	200(W) x 200(D) x 1200(H) x 2mm	\$319.00 / ea
21-GDP250-Y	250(W) x 250(D) x 1200(H) x 2mm	\$359.00 / ea



Stainless Steel Corner Guard (No Holes)

- Size: 40 x 40 x 1200(L)mm
- Thickness: 1.6mm

code	1-9	10-24	25+
21-SSCG40	\$89.00 / ea	\$79.00 / ea	\$65.00 / ea



Galvanised Steel Corner Guard

50mm Profile (no holes)

- Size: 50 x 50 x 1200(L)mm
- Thickness: 2mm

100mm Profile (with holes)

- Size: 100 x 100 x 1200(L)mm
- Thickness: 3mm

code	description	1-9	10+
21-GCG-50	50mm	\$65.90 / ea	\$59.90 / ea
21-GCG	100mm	\$119.00 / ea	\$108.00 / ea

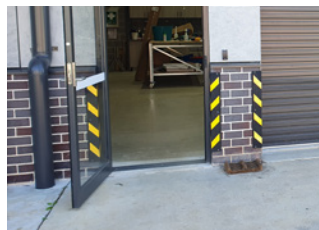

Rubber Corner Guard

- Size: 100 x 100 angle x 800(L)mm
- Colour: Black/Yellow Hi-Vis or Plain Black

code	description	1-9	10+
21-RCP-BY	Black/Yellow	\$32.00 / ea	\$26.50 / ea
21-RCP-B	Plain Black	\$32.00 / ea	\$26.50 / ea



PVC Corner Guard

- Size: 50 x 50 x 1200(L)mm
- Thickness: 2.5mm
- Colour: White

code	1-19	20+
21-PVC5012	\$74.90 / ea	\$62.90 / ea

* Small order charge \$25.00+GST for less than 10.

Kerb Ramps



Reflective Kerb Ramp (100mm High)

- Centre modules: 600(L) x 300(D) x 100(H)mm
- End module: 300(L) x 300(D) x 100(H)mm

code	description	1+
38-RKRM10	Centre Module	\$94.00 / ea
38-RKRE10	End Module	\$59.00 / ea
38-RKRFC	Fastener Set - M14 x 75mm Plug & Coach Screw - Set of 2	\$6.00 / Kit

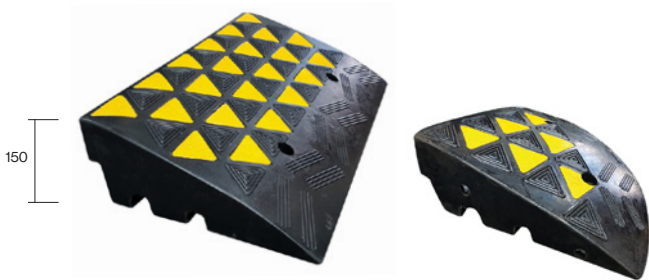

Reflective Kerb Ramp (150mm High)

- Centre modules: 600(L) x 360(D) x 150(H)mm
- End module: 360(L) x 360(D) x 150(H)mm

code	description	1+
38-RKRM15	Centre Module	\$125.00 / ea
38-RKRE15	End Module	\$79.00 / ea
38-RKRFC	Fastener Set - M14 x 75mm Plug & Coach Screw - Set of 2	\$6.00 / Kit



Reflective Kerb Ramp (200mm High)

- Centre modules: 600(L) x 450(D) x 200(H)mm
- End module: 450(L) x 450(D) x 200(H)mm

code	description	1+
38-RKRM20	Centre Module	\$189.00 / ea
38-RKRE20	End Module	\$119.00 / ea
38-RKRFC	Fastener Set - M14 x 75mm Plug & Coach Screw - Set of 2	\$6.00 / Kit

Vehicle Cable Covers

Rubber Channel Hose Ramp Medium

- Suits hose up to 90mm
- Weight: 12kg

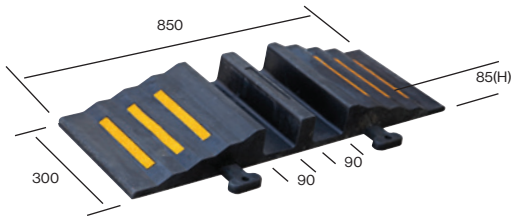

code	1+
38-RHR-M	\$129.00 / ea

Rubber Channel Hose Ramp Large

- Suits hose up to 150mm
- Weight: 22kg

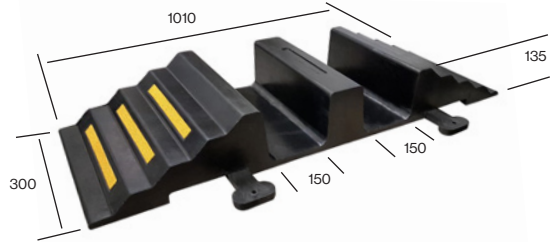

code	1+
38-RHR-L	\$189.00 / ea

Flip Top Cable Cover Small Flip Top Cable Cover Large

- Size: 1000(L) x 250(W) x 45(H)mm
- 2 Cable channels - 30 x 30mm each
- Weight: 7.5kg



code	1-9	10+
33-CABC-S	\$99.00 / ea	\$89.00 / ea

Flip Top Cable Cover Large

- 3 Channel**
 - Size: 900(L) x 600(W) x 75(H)mm
 - Channel Size: 60 x 50mm
 - Weight: 19kg
- 5 Channel**
 - Size: 915(L) x 500(W) x 60(H)mm
 - Channel Size: 35 x 35mm
 - Weight: 19kg

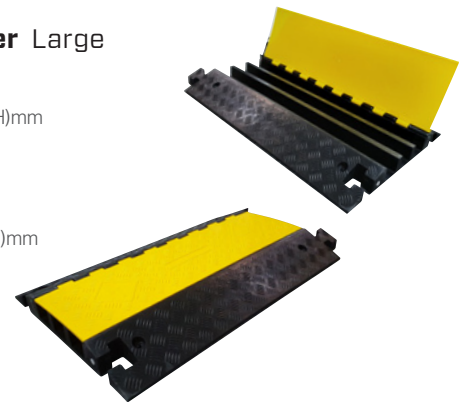

code	description	1-9	10+
33-CABC	3-Channel	\$175.00 / ea	\$159.00 / ea
33-CABC-5C	5-Channel	\$199.00 / ea	\$169.00 / ea

40mm Cable/Hose Drop Over Humps

- Size: 1000(L) x 350(W) x 75(H)mm
- Weight: 12kg

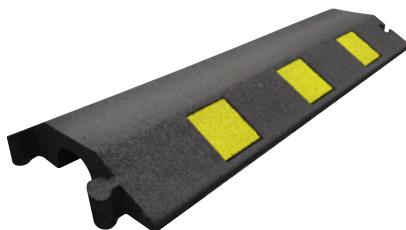
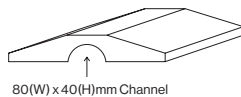

code	1-5	6+
33-CHH-84	\$282.00 / ea	\$259.00 / ea

80mm Cable/Hose Drop Over Humps

- Size: 1000(L) x 550(W) x 110(H)mm
- Weight: 22kg

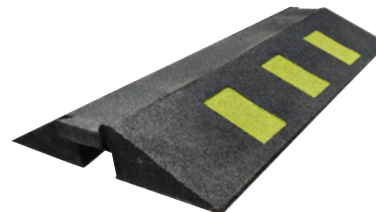
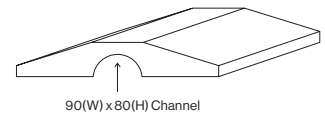

code	1-5	6+
33-CPR8	\$395.00 / ea	\$372.00 / ea

Tactile Indicators

Tactiles - Acrylic Peel and Stick



- Size: 300mm x 300mm
- Fast, easy installation - saves on labour
- Can be walked on immediately
- Suitable for indoor and outdoor applications.
- Complies to AS/NZS 4586 for slip resistance. R12.
- Complies to AS/NZS 1428.4.1:2009 for tactiles for vision impaired.
- Colours: Yellow, Charcoal (black), Light Grey
- P5 anti-slip rating

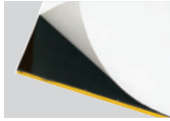

✓ Tactiles are GST Free

code	1-19	20-49	50-99	100+
As shown top right	\$42.90 / ea	\$36.90 / ea	\$33.90 / ea	\$28.90 / ea

Tactile Pad Rubber

- Complies with AS/NZS 1428.4.1:2009
- Size: 600 x 300mm
- Stock colours: Yellow, Black, Grey, Terracotta & Ocean Blue
- P5 anti-slip rating
- Requires epoxy

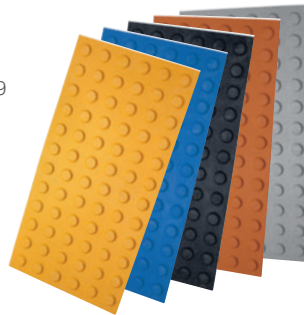

✓ Tactiles are GST Free

code	description	1-19	20+
40-RCTT-Y	Tactile Pad - Yellow	\$68.90 / ea	\$59.50 / ea
40-RCTT-B	Tactile Pad - Black	\$68.90 / ea	\$59.50 / ea
40-RCTT-G	Tactile Pad - Grey	\$68.90 / ea	\$59.50 / ea
40-RCTT-T	Tactile Pad - Terracotta	\$68.90 / ea	\$59.50 / ea
40-RCTT-OB	Tactile Pad - Ocean Blue	\$68.90 / ea	\$59.50 / ea

Tactile Plate Fibreglass

- Material: UV Stabilised resin / reinforced embedded fibreglass
- P5/R12 Slip Rating
- Hazard or Directional
- Colours: Yellow, Black or Ivory
- Fixing Method: Plugged, Screwed and glued (Fixings included)
- Complies with AS1428.1-2009
- Size: 600x300x2mm

✓ Tactiles are GST Free

code	description	1-19	20+
40-FCTT-DB	Directional Black	\$69.90 / ea	\$63.90 / ea
40-FCTT-DY	Directional Yellow	\$69.90 / ea	\$63.90 / ea
40-FCTT-DW	Directional Ivory	\$69.90 / ea	\$63.90 / ea
40-FCTT-HB	Hazard Black	\$69.90 / ea	\$63.90 / ea
40-FCTT-HY	Hazard Yellow	\$69.90 / ea	\$63.90 / ea
40-FCTT-HW	Hazard Ivory	\$69.90 / ea	\$63.90 / ea

Directional Tiles

40-ACCT-DY

40-ACCT-DC

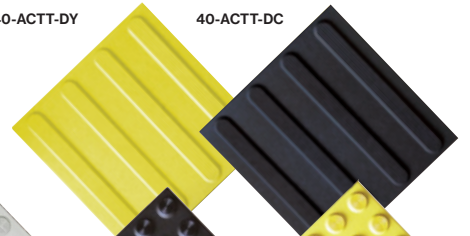

Hazard Tiles

40-ACCT-G

40-ACCT-C

40-ACCT-Y

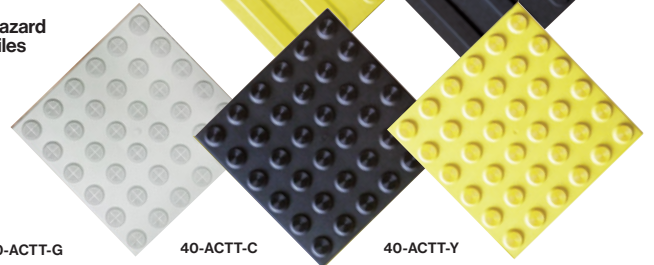

Two Part Tactile Epoxy 5kg

- The correct adhesive for applying pads to concrete, asphalt, timber, ceramic tiles, steel etc
- Coverage: 25-35 Tactile Pads (300 x 600mm)



*GST applies to epoxy

code	1+
40-RCTTG-5	\$159.00 / ea

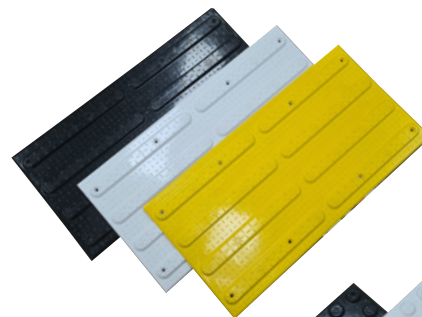

DIRECTIONAL

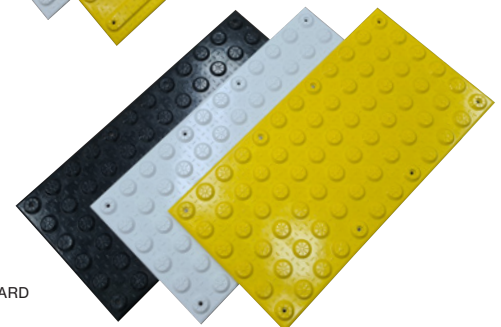

HAZARD

Speciality products

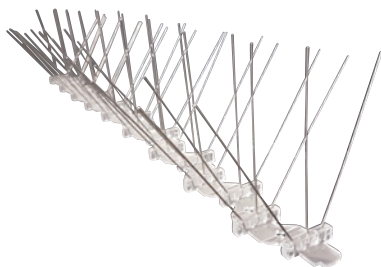

Bird Deterrent Spikes Triple

- Size: 600(L)x150(W)x115(H)mm, Base 50(W)mm
- 25 lengths per carton = 15Lm

code	5-24	25-100	101+
43-BS60	\$15.50 /length	\$13.90 /length	\$11.90 /length



Extruded Rubber Hump Bund

- Size: 115(W) x 40(H) x 5000(L)mm

code	description	1-4	5+
28-RBS115	Rubber Bund	\$449.00 /roll	\$399.00 /roll
28-SBS	Sealant Adhesive 600mL	\$33.90 /ea	



115L General Purpose Spill Kit

- Includes:
 - 2 x 1.2m booms
 - 1 x 2.4m boom
 - 25 x pads
 - 2 x 50L floor sweep bags
 - 3 x disposal bags
 - 1 pair PVC gloves

code	description	1+
28-SKGPB120	115L Portable Kit	\$679.00 /kit
28-SKGPB120-R	115L Refill Kit	\$489.00 /kit



240L General Purpose Spill Kit

- Includes:
 - 4 x 1.2m booms
 - 2 x 2.4m booms
 - 50 x pads
 - 3 x 50L floor sweep bags
 - 6 x disposal bags
 - 1 pair PVC gloves

code	description	1+
28-SKGPB240-R	240L Refill Kit	\$719.00 /kit
28-SKGPB240	240L Portable Kit	\$885.00 /kit

Traffic Control

Gorilla Cones

- 1m high
- Heavy 9kg base
- Fully stackable
- 250mm Class 1 reflective



code	1-19	20+
20-1000GC	\$58.50 / ea	\$49.90 / ea

Traffic Cones Reflective

- 450mm or 700mm size
- Fully stackable



code	description	1+
20-TC450R	450mm w/150mm Reflective	\$29.90 / ea
20-TC700R	700mm w/250mm Reflective	\$44.90 / ea

T-Top Bollards

- T-Top Bollards with heavy base and reflective collar.
- Height: 1150mm



code	1-19	20+
20-1150BL	\$52.90 / ea	\$46.90 / ea

Stackable "Mighty" Bollard

- 1m high
- Heavy 8kg base
- Fully stackable, even with base attached
- With 'T-Top' handle
- With Class 1 Reflective



code	1-9	10+
20-SMC1M	\$54.90 / ea	\$49.90 / ea

Barrier Tape Red/White

- Coloured on both sides with U.V. resistant inks.
- Size: 75 x 100m



code	1+
20-400	\$14.90 / Roll

Retractable Barrier Bar

- Extendable bar
- Extends up to 2m
- Reflective



*Cones Supplied seperately.

code	1-5	6+
20-RBBAR	\$36.00 / ea	\$29.50 / ea

Sign Posts & Brackets

Single Sided Sign Bracket 1 Piece

- For 50mm N.B. (60mm O.D.) posts
- With bolt and washer



code	1-99	100+
13-SSPB	\$6.70 / ea	\$5.80 / ea

Double Sided Sign Bracket 1 Piece

- For 50mm N.B. (60mm O.D.) posts
- With 2 bolts and nuts



code	1-99	100+
13-DSPB	\$11.20 / ea	\$10.40 / ea

2 Piece Sign Bracket For Existing Sign Posts

- For 50mm N.B. (60mm O.D.) posts
- With bolt and washer
- Single sided



code	1-19	20+
13-2PSB	\$18.80 / ea	\$16.90 / ea

Parking Sign Brackets For Offset Positioning

- Supplied with bolts
- Requires 2 brackets (top & bottom)
- Double length supports 2 signs



code	description	1-19	20+
13-PBD	Double (for 2 signs)	\$18.50 / ea	\$16.20 / ea
13-PBS	Single (for 1 sign)	\$13.50 / ea	\$11.80 / ea

Arc Sign Brackets For Signs with Bracing

- For 50mm N.B. (60mm O.D.) posts with bolt & nut



code	1-99	100+
13-6NRB	\$11.40 / ea	\$9.95 / ea

Sign Bracing

- Aluminium bracing is for making large signs rigid and can be easily attached with rivets or double sided tape.
- Supplied in 3m length
- Factory fitting available - POA

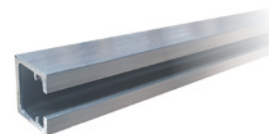

* Other lengths available, please enquire.

code	1+
13-980-3	\$82.90 / ea

Rapid Set Concrete Mix

- 20kg bag
- Hardens in 15 minutes with approximately 2.5L water



code	1+
22-RSC	\$29.90 / ea

Construction Grout

- Fine builders flow grout (non-shrink)
- Mix to your desired consistency
- 20kg bag



code	1+
GROUT20KG	\$29.90 / ea

Sign Posts & Brackets

Sign Post (In-ground)

- 50mm N.B galvanised steel posts (60mm outside diameter).
- Length: 3.2m



code	1-9	10+
13-5032SP	\$84.90 / ea	\$76.90 / ea

Sign Post (with Base Plate)

- 50mm N.B. galvanised steel posts (60mm outside diameter)
- Length: 2.6m
- Base: 130 x 130mm with 12mm holes



- * 3.2m length also available - please enquire

code	1+
13-50SPBP	\$119.90 / ea

Caps for Sign Posts

- For 50mm N.B. (60mm O.D.) posts



code	description	1+
13-50CSP	Caps for 60mm O.D. Posts	\$6.40 / ea

'V' Type Post Sockets

- Galvanised, flush-to-ground type socket for setting in concrete.
- Includes wedge
- Length: 275mm

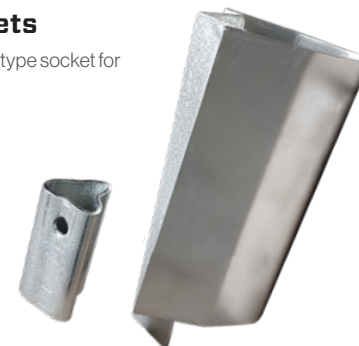

code	1-9	10+
10-VLOCK	\$69.90 / ea	\$57.50 / ea

Metal Spike Post Sockets

- To be driven in soil to hold sign posts
- Includes wedge
- Length: 440mm



code	1-9	10+
10-45SPS	\$53.90 / ea	\$44.50 / ea

Sign Post Base Plate Socket

- Size: 150x150 x 200(H)mm
- With 14mm holes
- Includes wedge

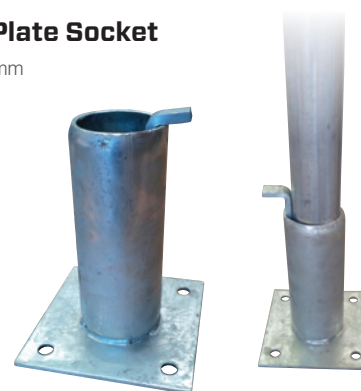

code	description	1-19	20+
10-BPSPS		\$69.90 / ea	\$56.90 / ea

Traffic Signage

Road Signs

- Class 1 Reflective
- Prices apply to signs shown here excluding made-to-order signs
- Aluminium backing

size	1+
300 x 300mm	\$77.00 / ea
300 x 400mm	\$77.00 / ea
150 x 1150mm	\$89.00 / ea
450 x 450mm	\$82.00 / ea
450 x 600mm	\$89.00 / ea
450 x 750mm	\$109.00 / ea
450 x 900mm	\$129.00 / ea
600 x 400mm	\$89.00 / ea
600 x 600mm	\$109.00 / ea
600mm Round	\$139.00 / ea
600 x 750mm	\$109.00 / ea
600 x 800mm	\$109.00 / ea
750mm Triangle	\$149.00 / ea
800 x 500mm	\$119.00 / ea

The above prices apply here unless individually marked otherwise.

*Made to order - lead time applies.



R1-1
(A 600 x 600)



R1-2
(A 750)



R1-3*
(A 750)



R2-2
(A 450 x 600)
L or R



R2-11
(A 450 x 750)*



R2-6 NSW
(A 450 x 900)
L or R



R2-17
(A 450 x 750)



R2-14
(A 600 x 800)
L or R



R8-2
(A 300 x 400)*



R7-1-4
(A 450 x 600)*



R2-4 NSW
(A 450 x 750)



R4-4
(A 450 x 750)



R4-5
(A 450 x 750)



R2-3
(A 450 x 600)
Left or Right



G9-18
(A - 600 x 450)*



R2-10
(A 600 x 600)



R2-209
(A 150 x 1150)



W8-25
(A 600 x 400)*



W8-22
(A 600 x 400)*



R3-1
(A 600)



D4-6X
(A - 600 x 750)*



OJ-WWAR*
(A 450 x 600)
\$99.00 ea (Custom)



R4-1#
(A 450 x 600)



Specify speed when ordering



W2-204
(A 600 x 600)*



W3-1
(A 600 x 600)*



W6-2
(A 600 x 600)



W1-3 L or R
(A 600 x 600)*



W5-22
(A 600 x 600)



W6-1
(A 600 x 600)



W6-3
(A 600 x 600)



W5-9
(A 600 x 600)*



W3-2
(A 600 x 600)*



W5-10
(A 600 x 600)



W3-4
(A 600 x 600)



W2-7
(A 600 x 600)*



W8-207 L
(A 800 x 500)*



W8-207 R
(A 800 x 500)*



W6-209
(A 600 x 600)*



W6-216
(A 600 x 600)*



R2-4
(A 450 x 450mm)
(B 600 x 600mm)



R2-6A(L)
(450 x 450mm)
R2-6B(L)
(600 x 600mm)



R2-6A(R)
(450 x 450mm)
R2-6B(R)
(600 x 600mm)



R2-5
(A 450 x 450mm)
(B 600 x 600mm)



W3-3
(A 600 x 600)*



W6-6
(A 600 x 600)*



R6-15
(A 300 x 300mm)*
(B 450 x 450mm)
(C 600 x 600mm)



R6-10-3
(A 450 x 450mm)
(B 600 x 600mm)



R6-10-1A
(600 x 600mm)



R6-10-2A
(600 x 600mm)

Parking Signs

Parking Signs

- Non-reflective Aluminium
- Specify left (-L), right (-R) or double arrows (-LR)
- 225(W)x450(H)mm

QTY	1+
1-9	\$39.90 / ea
10-29	\$34.90 / ea
30+	\$29.90 / ea

Price for signs shown here only.

✓ Custom signs available



R5-NS



R5-35
Not App. NSW



R5-40



R5-10DO

Parking Signs - Made-To-Order

- Non-reflective Aluminium
- Specify left (-L), right (-R) or double arrows (-LR)
- 225(W) x 450(H)mm

Price for signs shown here only.

qty	1+
1+	\$49.90 / ea

Durable 1.6mm Aluminium

Specify times

Left, Right or Double Arrow

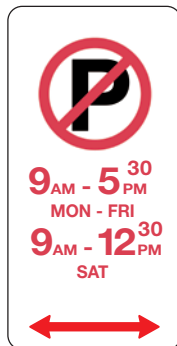

R5-41



R5-20



R5-13



R5-1



R5-26



R5-21



R5-23



R5-25



R5-24

Car Park Signs

- Non-reflective metal

Price for signs shown here only.

SIZE	1+
225 x 300	\$36.90 / ea
300 x 450	\$39.90 / ea
450 x 600	\$49.90 / ea
600 x 600	\$79.00 / ea
900 x 900	\$POA



TC426LSM (300 x 450)
TC426LM (450 x 600)



01-CP07C (225 x 300)



TC446LSM (300 x 450)



TC416MM (225 x 300)
TC416LSM (300 x 450)
TC416LM (450 x 600)



G7-6-1
(A - 600 x 600)
(B - 900 x 900)



01-CP06C (225 x 300)



01-PWPMM (225 x 300)
01-PWPLSM (300 x 450)
01-PWPLM (450 x 600)



TC457LSM (300 x 450)
TC457LM (450 x 600)



TC454LS (300 x 450)



01-SCOMM (300 x 450)



01-CSMM (225 x 300)
01-CSLSM (300 x 450)
01-CSLM (450 x 600)



Building & Construction



Shopping Centres



Clubs & Function Centres



Facility Maintenance & Property Management



Education



Transport Hubs



Industrial



Health & Aged Care



Parks & Landscaping

www.areasafe.com.au

NSW Government Schools

EDConnect -
Vendor No. 100301263 –
Gold status

VIC Education

Approved Vendor No.
CR21117E

TAFE Victoria

Vendor No.
ARSAPR.00

Downer Group

Vendor No.
1017152

Programmed Facility Management

Vendor No.
S10484

QLD State Schools

Vendor No.
S00007620

SA Schools

Vendor No.
AREASAF

Unimarket

Charles Sturt University &
University of Tasmania

Programmed Property Services

Vendor No.
24122

City Holdings

Vendor No.
C002468

Catholic Schools Offices

Preferred Supplier

TAFE NSW

Vendor No. 100301263
(Ariba #1020)

Portalink

Multiple Universities

Spotless Group

Vendor No.
2023373

Buy.NSW Supplier

Scheme No.
SCM0256



LB303 & LB304



The Area Safe Group



Email:

sales@areasafe.com.au

Mail:

PO Box 82, Plumpton NSW 2761

Address:

17 Sterling Road, Minchinbury NSW 2770

Hours:

Open from 7:00am - 5:00pm, Monday to Friday